

 **katena**
DESIGNED FOR SIGHT®

INSTRUMENTS
BIOLOGICS
DEVICES





INSTRUMENTS • BIOLOGICS • DEVICES

BLANK



About Us:

Katena is the largest independently owned American company dedicated exclusively to ophthalmic surgical instrumentation. Katena markets its products directly to customers in the United States and through a global network of distributors in more than 110 countries around the world.

Established 1975, Katena is committed to:

- Developing innovative instruments to support new surgical techniques and technological advances in the field of ophthalmology.
- Producing instruments of consistently excellent quality.
- Providing unexcelled service to its customers and strong support for its distributors worldwide.

General Information:

Products in this catalog are listed numerically wherever possible. The “Table of Contents” identifies product groups by catalog number prefix.

Photographs in this catalog are actual size except where otherwise noted. Illustrations are enlarged to show detail.

Surgical instruments shown in this catalog are made of stainless steel, unless otherwise indicated.

All specifications are subject to change without notice.

Original photographs, illustrations and text in this catalog are copyrighted and may not be reproduced in any form without written authorization by Katena Products, Inc.

Katena[®], K-Sponge[®], Performance[™], Phaco-4[™], UltraKleen[™], Designed for Sight[™], are trademarks of Katena Products, Inc.

IOPatch, BioElevation, BioDome, Ambio5, keraSys and tarSys are registered trademarks of Innovative Ophthalmic Products, Inc. Ambio2 and AmbioDisk are trademarks of Innovative Ophthalmic Products, Inc. SutureGroove is a registered trademark of Advanced Meditech International – and is used with permission. Tutoplast is a registered trademark of Tutogen Medical – and is used with permission.

STAAR[®] and ICL[™] are trademarks of STAAR Surgical Company, Inc. of Monrovia, CA.

IntraLase[®] is a registered trademark of the IntraLase[®] Corp, of Irvine, CA.

Orders • Terms & Conditions • Guarantee

ORDERS

Order processing is simple at Katena. Please use one of the convenient methods below.

Telephone: (800) 225-1195 or (973)989-1600.

Our customer service representatives are available from 8:30am to 5pm EST.

Fax: (973) 989-8175

Web: www.katena.com

Email: globe@katena.com

SHIPMENT

Orders are usually processed within 24 hours after receipt. Shipments are made F.O.B. Denville, NJ via insured UPS, unless otherwise specified by the customer. Visible damage or apparent shortages must be noted on the carrier's delivery document. Customer shall inspect all items received upon arrival and report any error in shipment or damage within 72 hours by calling Katena at 1-800-225-1195.

PAYMENT

Our terms are Net 30 days. We currently accept: Visa, MasterCard, American Express, checks drawn on US banks, and wire transfers.

REPAIRS

Katena has a full service repair and refurbishment department. All of our technicians have completed a rigorous, multi-year training & apprenticeship program, and have achieved the highest level of "Master Craftsman". Our repair department can service all brands of hand-held ophthalmic surgical instruments. For instructions on sending an instrument to us, please use the repair form on page 250 of this catalog or under the "forms" button at www.katena.com.

UNCONDITIONAL GUARANTEE

All Katena Instruments are unconditionally guaranteed against manufacturing defects. Any instruments found to have a manufacturing defect will be repaired or replaced free of charge.

RETURNED GOODS

All products returned to Katena must be carefully packaged and shipped prepaid and insured to our Denville address. Each shipment must be accompanied by a document showing full name and address of sender, list of items, and reason for their return.

Merchandise returned for credit will be accepted under the following terms and conditions:

1. Full credit will be issued for all merchandise returned within 30 days after the date of our shipment, providing the product is received by us in perfect condition and in its original package.
2. Returns within 30-90 days after shipment are subject to a 10% restocking charge.
3. Returns after 90 days are not acceptable for credit.
4. Any product returned in non-resaleable condition, or not in its original container, is subject to a restocking charge of 10% to 20% according to its condition.

The following items cannot be accepted for credit except those resulting from an error made by Katena:

- a. Custom made instruments
- b. Discontinued models
- c. Damaged, abused, or etched instruments
- d. Sterile products

Table of Contents

Catalog Number Prefix	Product Group	Page Number
K1	Speculums • Scleral Depressors • Lid Plates • Fascia Needle • Retractors	1 - 19
K2	Knives • Spuds • Burrs • Blade Breakers • Diamond Knives Trabeculectomy Punches	20 - 29
K3	Spatulas • Choppers • Manipulators • LASIK Spatulas • Lens Loops Manual Nucleus Fragmentation • Iris Retractors • Hooks • Fixation Rings Muscle Hooks • Corneal Markers • Toric IOL Markers • Calipers	30 - 78
K4	Scissors • IOL Cutters	79 - 95
K5	Forceps	96 - 132
K6	Needle Holders	133 - 138
K7	Rongeurs • Lacrimal Instruments • Cannulas • Irrigating Manipulators & Choppers • I/A Systems	139 - 168
K8	Eye Spheres • Bipolar Forceps	169 - 170
K9	Sterilizing Cases • Eye Shields • Accessories	171 - 179
K20	Disposables - • Barron Vacuum Trephines & Punches • Trephine Blades • Knives • Blades • Cannulas • Instruments • Sponges	180 - 199
IOP	Amniotic Membrane • Allografts • Glaucoma Implants Patch Grafts • Lid Weights	200 - 210
K10	Suggested Instrument Sets	211 - 240
	Index	241 - 249
	Repair Form	250

BLANK

Speculums

Barraquer

Wire Speculum

- K1-5000** standard wire, 10mm blades
- K1-5008** extra heavy wire, 15mm blades
- K1-5009** heavy wire, 15mm blades
- K1-5010** standard wire, 15mm blades
- K1-5355** infant size, 9mm blades

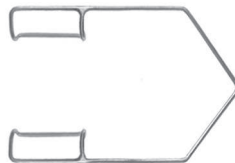

K1-5355

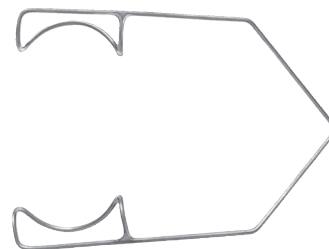

K1-5010

Grandon-Barraquer

Wire Speculum

with suture notches

Used to obtain additional traction for the upper eyelid.

- K1-5011** 15mm blades

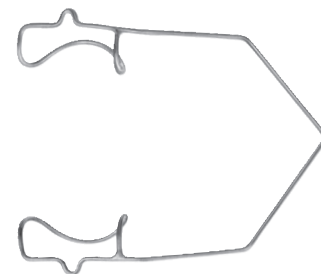

Temporal Approach

Wire Speculum

with spring on nasal side

- K1-5012** 15mm closed blades
- K1-5015** 15mm open blades
- K1-5014** 15mm solid blades

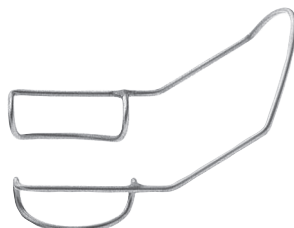

Speculums

Solid Blade

Wire Speculum

K1-5020 Barraquer, 10mm blades

K1-5030 Barraquer, 15mm blades

K1-5032 Feaster, 20mm blades (not shown)

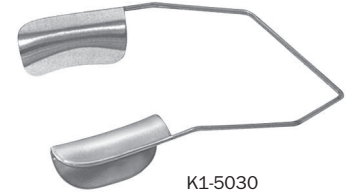
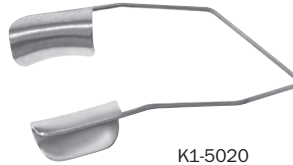

Kratz-Barraquer

Wire Speculum

15mm blades

one solid and one open wire

K1-5044 for right eye

K1-5045 for left eye

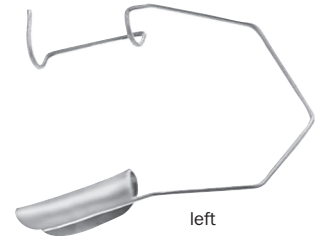
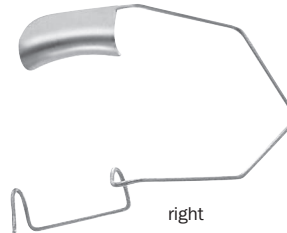

Kratz-Barraquer

Wire Speculum

with open blades

For unobstructed access to the cataract incision with phaco or I/A tip.

K1-5049 heavy wire, 15mm blades (not shown)

K1-5050 standard wire, 15mm blades

K1-5051 standard wire, 13mm blades

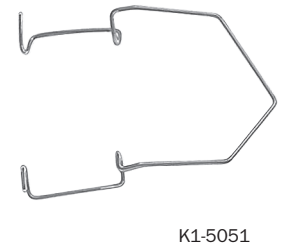
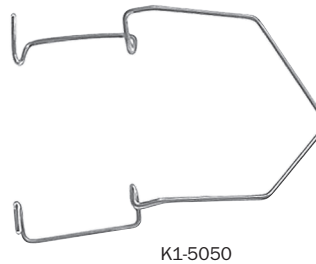

Speculums

Kratz-Barraquer

Wire Speculum
with wings
*For retracting the lids
up and away from the globe
to eliminate external pressure.*

K1-5060 15mm blades

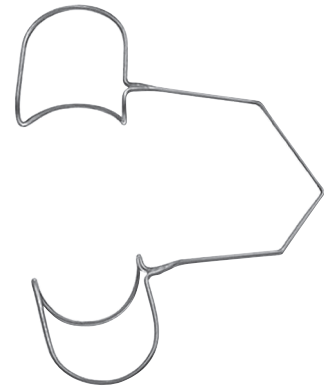

McIntyre

Wire Speculum
gently curved springs
*V-shaped blades are designed to
retain surgical drape under the eyelids.*

K1-5070 closed wire, 13mm blades

K1-5071 open wire, 13mm blades

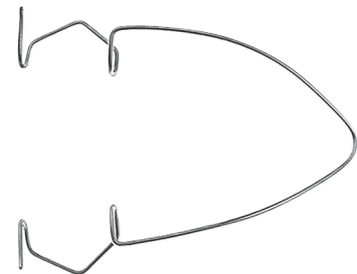
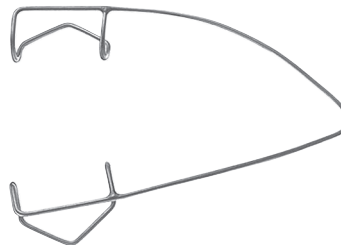

Nevyas

Wire Speculum
*Designed to retain surgical drape under the
eyelids while allowing unobstructed access to the
cataract incision with phaco or I/A tip.*

K1-5073 16mm blades

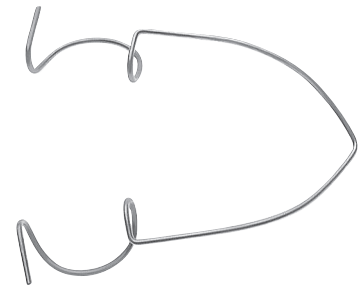

Speculums

Lieberman Style, aspirating

adjustable mechanism

Features aspirating ports to remove excess fluid from the surgical field.

Supplied with silicone tubing and luer-lock adaptor.

K1-5171 Lieberman, Kratz style, 15mm blades

K1-5173 Thorlakson, rounded, 11mm blades

K1-5175 Lieberman, V-shaped, 15mm blades

K1-5180 Chu, solid, reversible, 15mm blades

K1-5179 replacement silicone tubing, 100cm (39")



K1-5171

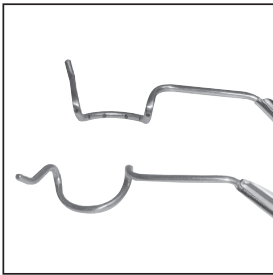

K1-5173

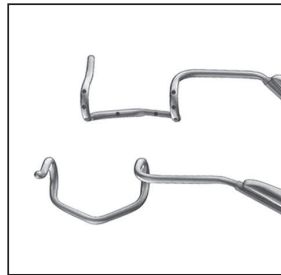

K1-5175



K1-5180

Double-X

Aspirating Speculum
adjustable, Kratz style
15mm blades

K1-5191

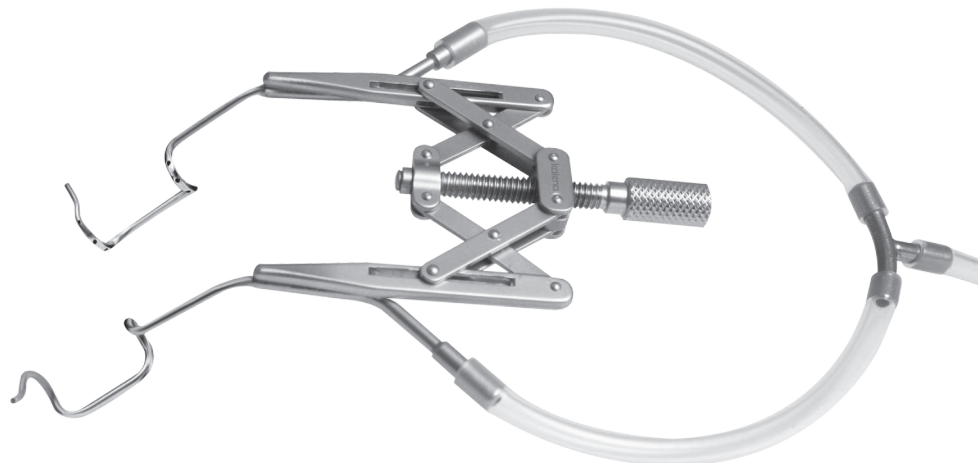

Speculums

Sauer

Lid Speculum

K1-5300 for infants, 11mm blades

K1-5302 for premature infants, 2mm blades



Frankel

Infant Lid Speculum
adjustable

*For precise control of
infant eyelid retraction.*

K1-5310 10mm blades



Infant

Wire Speculum

interlacing 3mm & 5mm blades

For use with newborns or infants.

K1-5330



Alphonso

Infant Lid Speculum

finger grips and interlacing blades
to facilitate insertion

one blade 5mm, one blade 7mm

K1-5340

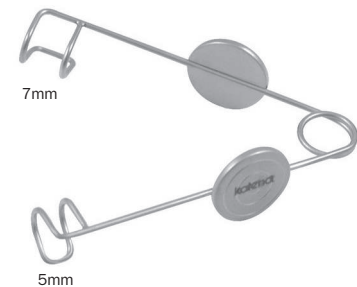

Speculums

Infant

Lid Speculum
 closed wire blades
 gently curved spring
K1-5350 4mm blades

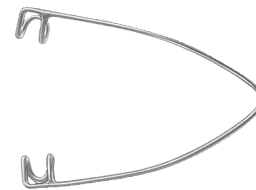

Femto

Lid Speculum
 flat 15mm wire blades
 with locking screw
K1-5390

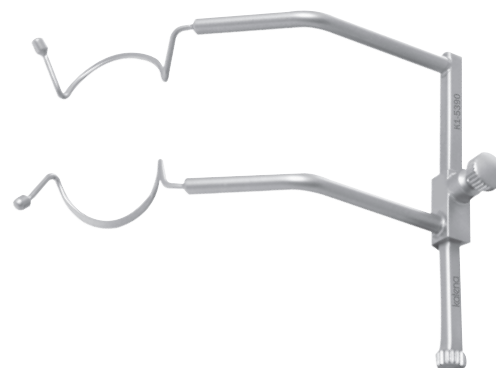

Cook

Eye Speculum
 with locking screw
K1-5401 #1, 8mm blades
K1-5402 #2, 11mm blades
K1-5403 #3, 15mm blades (not shown)



Speculums

Murdoch

Eye Speculum
with locking screw

K1-5406 #2, 12mm blades

K1-5407 #3, 15mm blades

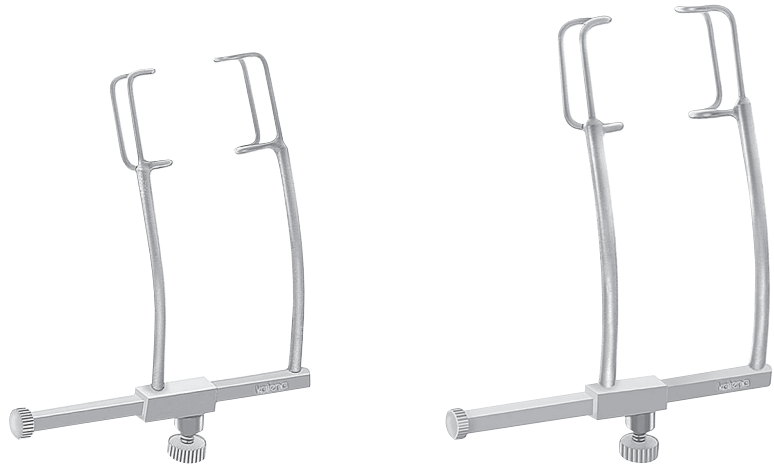

Mellinger

Eye Speculum
self retaining

*For unobstructed access to the
cataract incision with phaco or I/A tip.*

K1-5411 15mm blades



Speculums

Williams

Eye Speculum
with locking screw

K1-5500 11mm blades

K1-5510 15mm blades

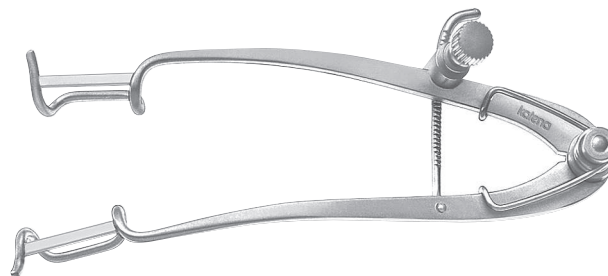

Lancaster

Eye Speculum
adjustable mechanism
with locking nut

K1-5600 16mm blades



Lester-Burch

Eye Speculum
with flanges on blades for
retaining eye lashes
adjustable mechanism
with locking screw

K1-5620



Lieberman Speculums

- K1-5660** Lieberman, infant K-wire, 5mm
- K1-5665** Lieberman, infant solid blade, 5mm
- K1-5668** Tanna-Lieberman, 15mm blades with traction suture anchor posts
- K1-5670** Lieberman, K-wire, 10mm blades, small
- K1-5671** Lieberman, K-wire, 15mm blades, standard
- K1-5672** Seltzer, flattened K-wire, 15mm blades
- K1-5673** Thorlakson, rounded, 11mm blades
- K1-5674** Lieberman, triple post, 13mm blades
- K1-5675** Lieberman, V-shaped, 15mm blades
- K1-5677** Lieberman, solid blades, 10mm blades (*not shown*)
- K1-5678** Lieberman, solid blades, 15mm blades
- K1-5679** Ginsberg, flared upper blades, fenestrated lower blades, 15mm blades

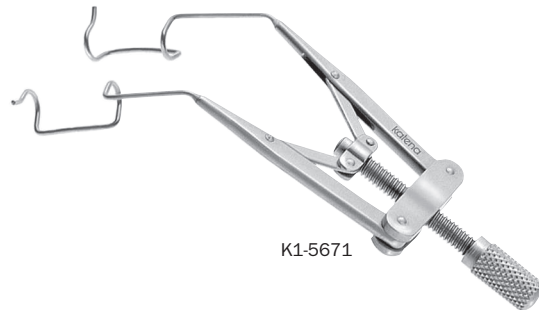

K1-5671

Aspirating versions available, see page 4.

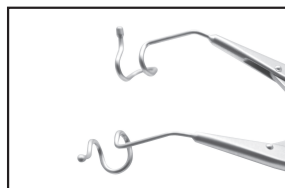

K1-5660

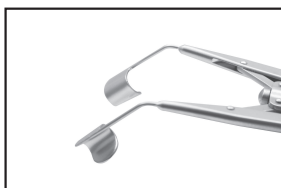

K1-5665

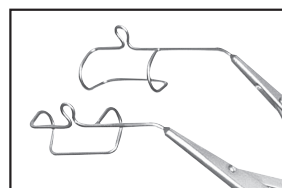

K1-5668

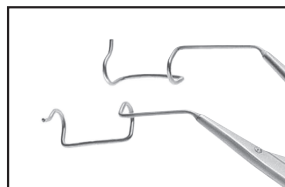

K1-5670

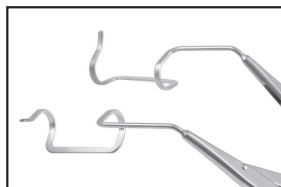

K1-5672

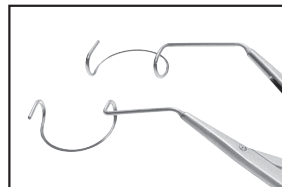

K1-5673

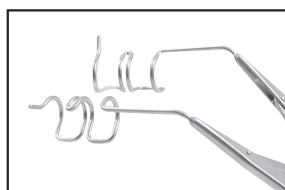

K1-5674

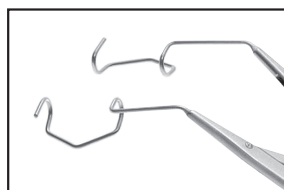

K1-5675

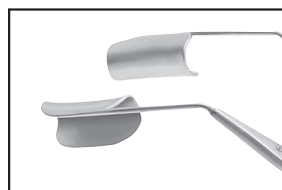

K1-5678

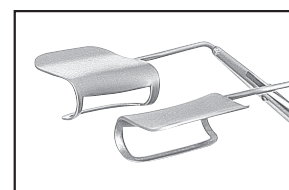

K1-5679

Speculums

Reversible

Eye Speculum
adjustable mechanism
non-reflective finish
*Designed for nasal or
temporal placement.*

K1-5680 15mm blades

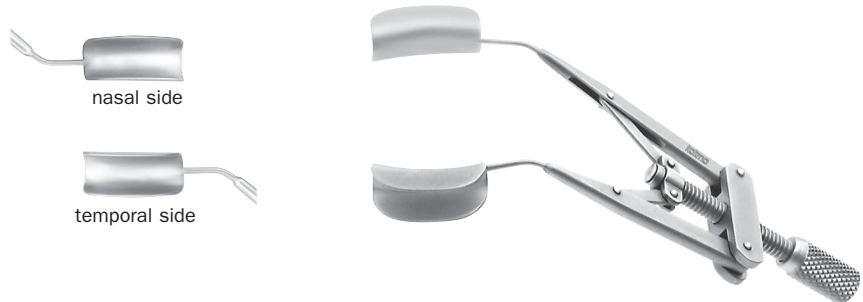

Lieberman

Temporal Approach Speculum
Kratz style open wire blades
adjustable mechanism on nasal side

K1-5681 15mm blades



Lieberman

Temporal Approach Speculum
V-wire blades
adjustable mechanism on nasal side

K1-5685 15mm blades



Double-X Speculums

K1-5690 K-wire, flattened 10mm (not shown)

K1-5691 K-wire, flattened 15mm

K1-5695 V-wire, flattened 15mm

K1-5696 Chu, flattened 17mm

K1-5697 Chu, flattened 13mm

K1-5698 Solid blades 15mm

Aspirating version available, see page 4.

patent pending

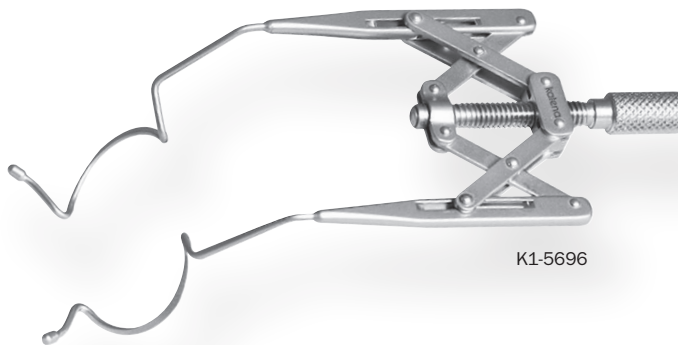

K1-5696



K1-5691 K-wire, 15mm

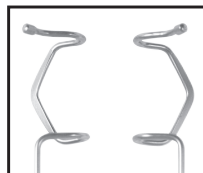

K1-5695 V-wire, 15mm

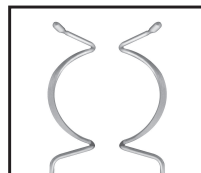

K1-5696 Chu, 17mm

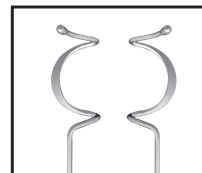

K1-5697 Chu, 13mm

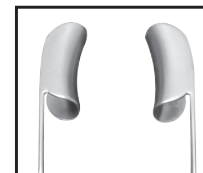

K1-5698 Solid blades

Key Features:

- ① Unique "Double-X" mechanism retracts blades in a parallel motion for even tension along the lid.
- ② As the lids are retracted the mechanism moves out of the way for unobstructed access.
- ③ Ball tips eliminate discomfort for patients with excess lid tissue.

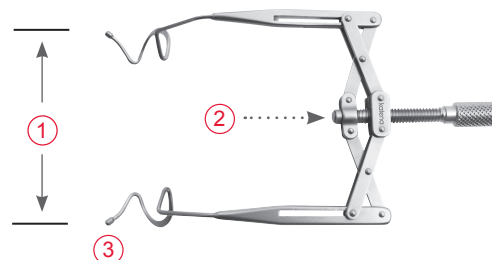

Speculums

Castroviejo

Eye Speculum
adjustable mechanism
K1-5701 14mm blades
K1-5702 16mm blades



Fishkind

Eye Speculum
open blades
adjustable mechanism
For use with phaco or I/A tip.
K1-5711 15mm blades

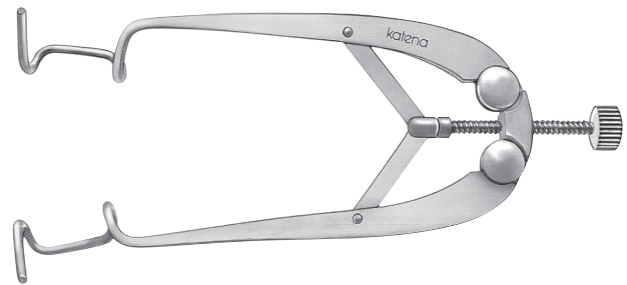

Maumenee-Park

Eye Speculum
with canthus hook
blade locking screws may be
positioned vertically or horizontally
K1-5800 15mm solid blades
K1-5810 15mm fenestrated blades
(not shown)

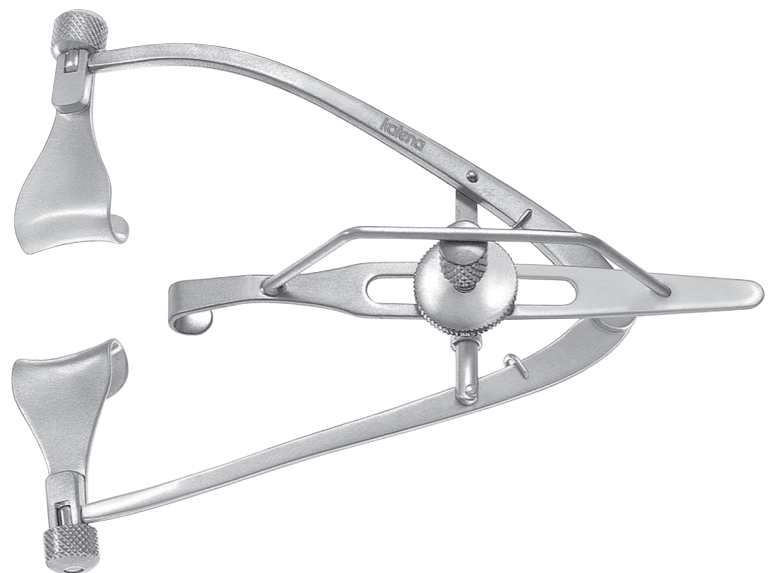

Speculums

Smirmaul

Eye Speculum
individually adjustable
blades for elevating eyelids
Ideal for glaucoma surgery.

K1-5950 15mm solid blades

K1-5951 15mm wire blades
(not shown)



Schott

Eye Speculum
with rotatable adjustment for
precise control of blade elevation
Ideal for glaucoma surgery.

K1-5955 16mm wire blades

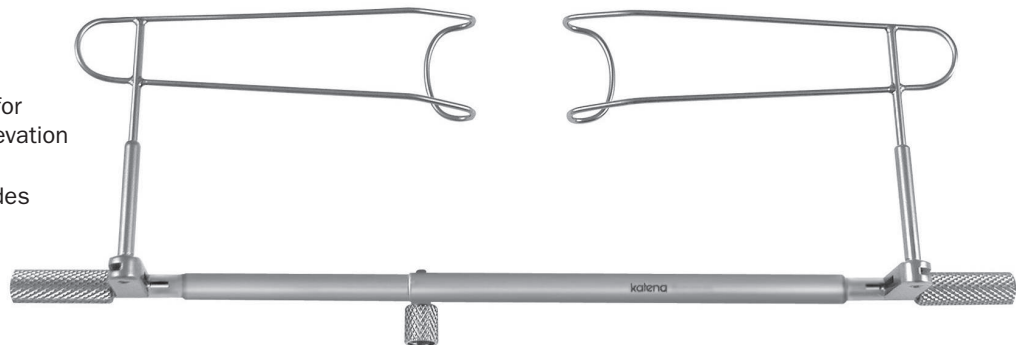

Fixation Rings

Flieringa

Scleral Fixation Ring

K1-7100 set of eight, 15mm-22mm

K1-7140 14mm diameter

K1-7150 15mm diameter

K1-7160 16mm diameter

K1-7170 17mm diameter

K1-7180 18mm diameter

K1-7190 19mm diameter

K1-7200 20mm diameter

K1-7210 21mm diameter

K1-7220 22mm diameter

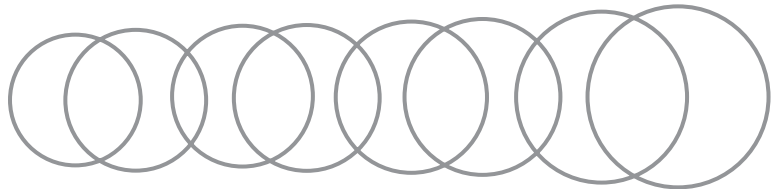

McNeill-Goldman

Scleral Fixation Ring
and Blepharostat

K1-7311 small, 15mm I.D.

K1-7312 medium, 16mm I.D.

K1-7313 large, 17mm I.D.

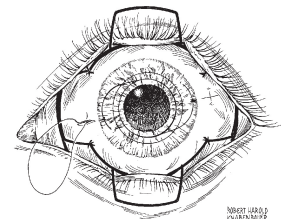

Depressors

Gass

Scleral Marker
1.5mm diameter marking tip

K1-7790



Schepens

Scleral Depressor
7mm wide tip

K1-7800 small thimble

K1-7810 medium thimble

K1-7820 large thimble



Schocket

Scleral Depressor
double-end with
pocket clip

K1-7825



Retractors

Schepens

Orbital Retractor
K1-7880



Jaffe

Wire Lid Retractor
 may be clamped to surgical drape with
 suture or elastic band

K1-8000 pair, 15mm blades
K1-8001 pair, 9mm blades (not shown)



Desmarres

Lid Retractor
 thin solid blades

K1-8200 size 0, 11mm wide
K1-8210 size 1, 13mm wide
K1-8220 size 2, 15mm wide
K1-8230 size 3, 17mm wide

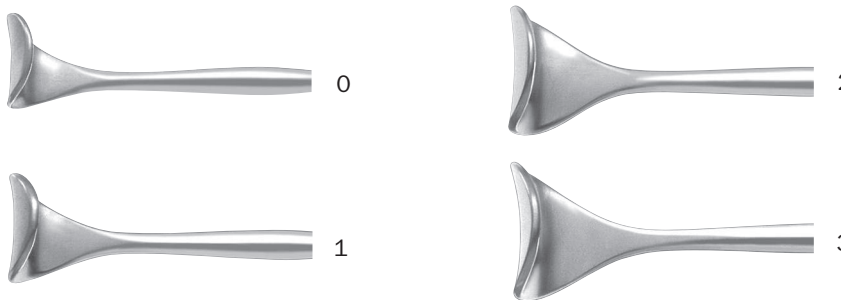

Retractors

Scleral Shield

stainless steel
 non-reflective exterior surface
*To protect the eye during blepharoplasty
 and skin resurfacing procedures.*

K1-8480 1 small, 1 large (set)

K1-8481 20 x 28mm, small (pair)

K1-8482 22 x 30mm, large (pair)



Jaeger

Lid Plate
 clear plastic

K1-8500



Jaeger

Lid Plate
 stainless steel

K1-8520



Wright

Fascia Needle
 1mm x 6mm oval hole
 140mm long

K1-8540



Retractors

Knapp

Lacrimal Retractor
4 prongs

K1-9000 blunt

K1-9001 sharp



Walton

Conjunctiva Retractor
6mm wide
thin solid blade

K1-9008

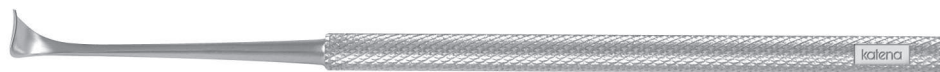

Helveston

Tissue Retractor
thin curved blade

K1-9010 "Barbie" 7mm wide

K1-9012 "Big Barbie" 9mm wide

K1-9019 "Great Big Barbie" 11mm wide concave blade



K1-9010



K1-9019

Retractors

Stevenson

Lacrimal Sac Retractor
 3 x 3 blunt prongs, adjustable
K1-9500

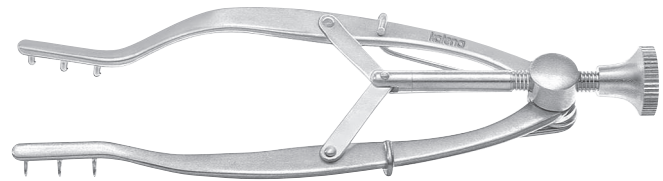

Stevenson

Lacrimal Sac Retractor
 solid blades with serrated edge
 adjustable
K1-9520 13mm blades

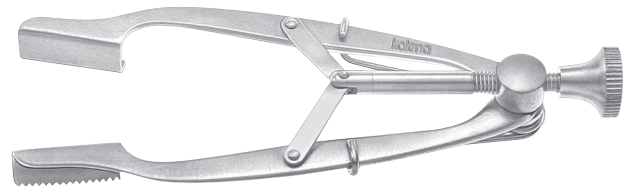

Agricola

Lacrimal Sac Retractor
 3 x 3 sharp prongs
K1-9550

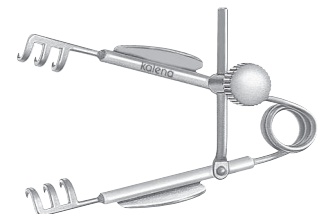

Knives

Tooke

Corneal Knife
straight blade
with curved cutting edge

K2-3650



Corneal Dissector

For intrastromal dissection.

K2-3660 angled, straight blade

K2-3661 angled, curved blade



K2-3660



K2-3661



Gill

Corneal Knife
curved cutting edge

K2-3700 straight

K2-3710 light curve



Fukasaku

"Hockey" Knife

sharp 3mm front edge

semi-sharp 6mm bottom edge

K2-3735



Spuds • Burrs

Foreign Body Spud

K2-4000 Golf Club, angled, lightly rounded tip

K2-4050 Francis, angled, flag shaped tip

K2-4100 Ellis, lightly curved and rounded tip



K2-4000



K2-4050



K2-4100



Spud & Gouge

in reversible handle

For removing foreign bodies.

K2-4600

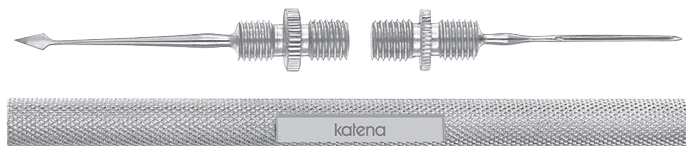

Wills Eye Hospital

Foreign Body Spud & Burr
delicate curved spud on one
end and small burr for rust
ring removal on opposite end

K2-4800



Burrs

Algerbrush II

K2-4900 Corneal Rust Ring Remover with protective cap, "AA" battery and two burrs

K2-4903 chuck for K2-4900

K2-4909 burr, 0.5mm

K2-4910 burr, 1.0mm



Pterygium Burr

K2-4912 Pterygium Burr with protective cap, "AA" battery and 3.5mm burr

K2-4913 replacement burr and chuck assembly for K2-4912



Katena

Ophthalmic Burr
for polishing pterygiums

K2-4920 Includes one 3.3mm diameter round diamond burr, two "AA" batteries and storage case.

K2-4923 diamond burr, round 3.3mm diameter

K2-4925 diamond burr, round 5.0mm diameter

K2-4935 diamond burr, disc shaped 5.0mm diameter

K2-4921 optional lithium hi-energy battery, 3.6 volt, for increased torque



K2-4923



K2-4925



K2-4935

Blade Breakers • Diamond Knives

Castroviejo

Blade Breaker and Holder
with sliding lock

K2-5000



Swiss Model

Blade Breaker and Holder
spherical tip

K2-5150

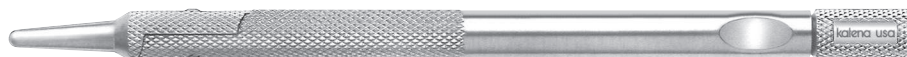

Diamond LRI Step Knife

6-facet blade for bi-directional cutting
single footplate for better visualization
precalibrated depth settings

K2-6518 Precalibrated
depth setting
of 0.6mm

K2-6519 Precalibrated
depth settings
of 0.5mm, 0.55mm
and 0.6mm

K2-6520 Chu LRI Knife,
0.6mm and
2.5mm preset

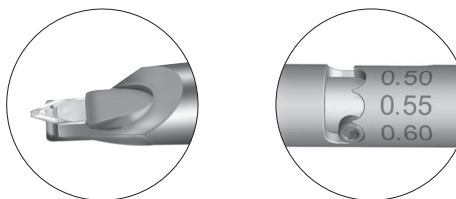

K2-6519

600 micron knife also available
sterile disposable K20-2560

Diamond Knives

Diamond LRI Micrometer Knife

6-facet blade for bi-directional cutting
single footplate for better visualization

K2-6522 0 to 1.5mm blade extension
in 10 micron increments

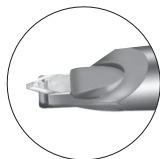

Diamond AK Knife

double
vertical and 45°
cutting edge

K2-6517

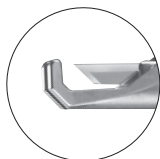

Precalibrated depth settings: 0.2, 0.25, 0.3, 0.35, 0.4, 0.6 and 1.5mm

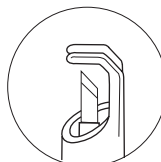
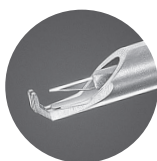
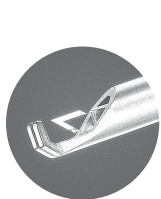

Diamond Micrometer Knife

single
45° cutting edge
1mm wide
200 microns thick

K2-6530

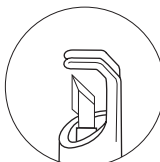

Diamond Micrometer Knife

double
vertical and 45°
cutting edge
200 microns thick

K2-6533



Diamond Micrometer Knife

Thornton "triple"
vertical and 15°
cutting edge with
100 microns base
cutting edge

K2-6535

Diamond Knives

Blade Gauge

For Katena micrometer knives.

K2-6539



K2-6539

Sterilizing Case

with silicone insert
autoclavable plastic

K2-6555 for one knife

K2-6556 for two knives

K9-2024 for three knives



K2-6555

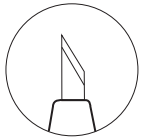
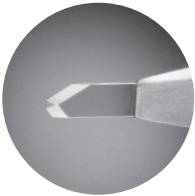

Diamond Knife

30° cutting edge
1mm wide

K2-6560

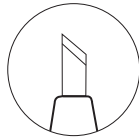

Diamond Knife

45° cutting edge
1mm wide

K2-6561

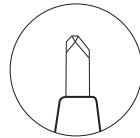

Diamond Knife

tri-facet
1mm wide

K2-6565

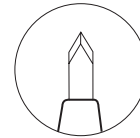

Diamond Knife

spear
1mm wide

K2-6567

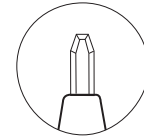

Diamond Knife

10-facet
1mm wide

K2-6568

Diamond Knives

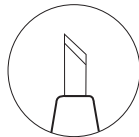
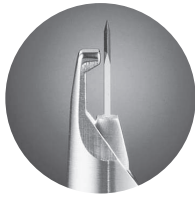

Diamond Step Knife
single 45° cutting edge
1mm wide
K2-6540

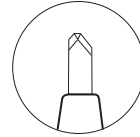

Diamond Step Knife
tri-facet
1mm wide
K2-6546

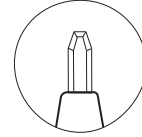

Diamond Step Knife
10-facet
1mm wide
K2-6548

Precalibrated depth settings: 0.2, 0.3, 0.4, 0.5, 0.6, 0.8 and 4.0mm

Diamond Crescent Knife
crescent shaped blade
2.5mm wide, angled
K2-6575

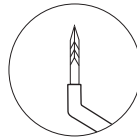
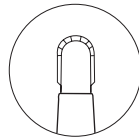

Diamond Phaco Knife
keratome shaped blade
K2-6578 2.8mm straight
K2-6579 2.8mm angled
K2-6580 3.0mm straight
K2-6581 3.0mm angled
K2-6582 3.2mm straight
K2-6583 3.2mm angled

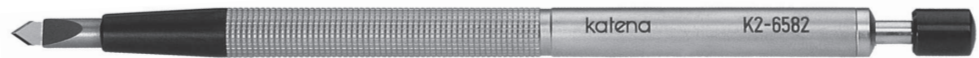
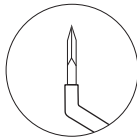
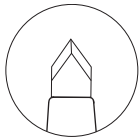

Diamond Knives • LASEK Trephines

Phaco-4 Diamond Knife

keratome shaped blade
4 cutting edges, angled

K2-6603 2.5mm wide

K2-6605 2.8mm wide

K2-6607 3.0mm wide

K2-6609 3.2mm wide

K2-6611 trapezoid
2.7 to 3.2mm

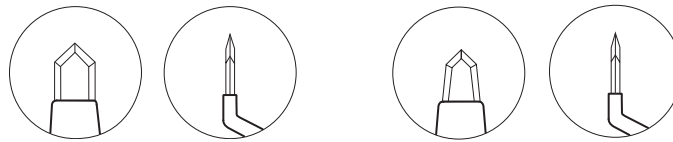

TRAPEZOID



MICS Diamond Knife

keratome shaped blade
4 cutting edges, angled

K2-6622 trapezoid, 1.8 to 2.2mm wide

K2-6654 trapezoid, 2.1 to 2.4mm wide

K2-6680 1.8mm wide

K2-6682 2.2mm wide

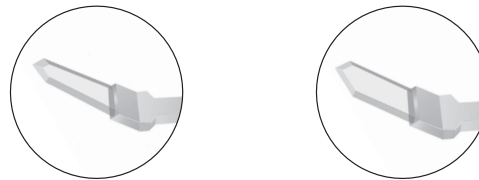

TRAPEZOID



Camellin Style

LASEK Trephine
270° semi-sharp edge
90° cutout for flap hinge

K2-7810 8mm diameter

K2-7812 9mm diameter



Camellin Style

LASEK Trephine &
Alcohol Retaining Well

K2-7830 8mm trephine
and 8.5mm well

K2-7832 9mm trephine
and 9.5mm well



Trabeculectomy Punches

Gass

Corneoscleral Punch
 1.5mm diameter head
 0.75mm deep bite
 rotatable tip for convenient positioning

K2-9500



Luntz-Dodick

Trabeculectomy Punch
 1.0mm diameter head
 with bullet shaped tip
 for scleral tunnel insertion
 0.5mm deep bite
*Cutting head can be preset
 in one of 4 positions to suit
 the surgeon's preference.*

K2-9505 complete

K2-9506 replacement cutting head

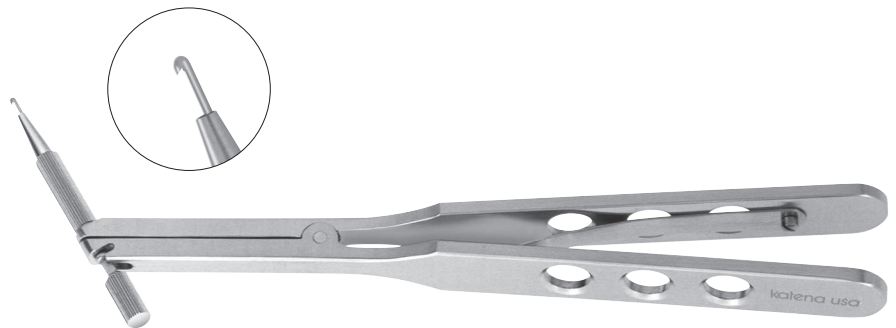

Kelly

Descemet's Membrane Punch
 1.0mm diameter head
 0.75mm deep bite

K2-9510

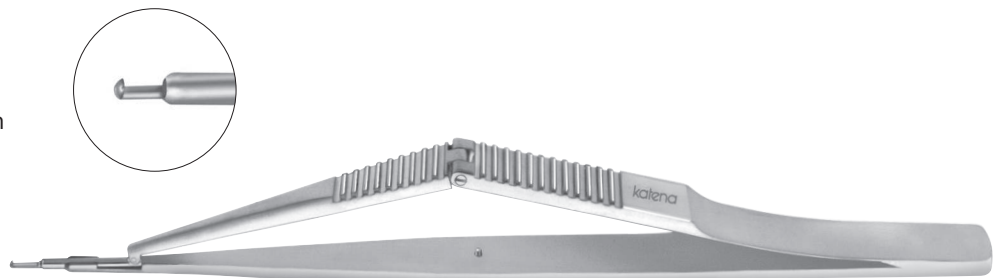

Trabeculectomy Punches

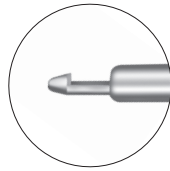

Fukasaku

Micro Trabeculectomy Punch
0.6mm diameter head
with bullet shaped tip
0.3mm x 0.6mm deep bite

K2-9512



Christensen

Punctum Punch
1mm wide bite
For opening stenotic punctums.

K2-9525



Curettes

Meyerhoefer

Chalazion Curette

K3-1000 size 0, 1.5mm dia.

K3-1010 size 1, 1.75mm dia.

K3-1020 size 2, 2.25mm dia.

K3-1030 size 3, 2.5mm dia.

K3-1040 size 4, 3.5mm dia.

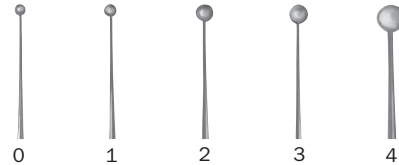

Capsule

Polishing Curette

1.75mm diameter open ring

K3-1100 **Nightingale**, semi-sharp, posterior edge

K3-1102 **Shepherd**, semi-sharp anterior and posterior edges



Scorsetti-Shepherd

Capsule Polisher

1.75mm diameter open ring

tip angled 90°

semi-sharp

anterior and posterior edges

K3-1105



Anis

Capsule Scrubber

flexible wire

textured disc

K3-1111

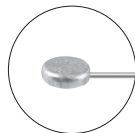

LASIK Flap Protectors

Blumenthal

Conjunctiva Dissector
with blunt disc shaped tip

K3-1124

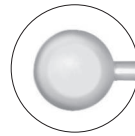

TOP VIEW

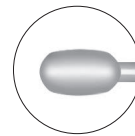

SIDE VIEW



Buratto

LASIK Flap Protector
*For retracting and protecting
nasally hinged corneal flaps.*

K3-1770



Mannis-Buratto

LASIK Flap Protector
blades angled 45°
*For retracting and protecting
superiorly hinged corneal flaps.*

K3-1773



LASEK Well

Rowen

Combination LASIK Flap
Protector and Spatula

K3-1774



Camellin Style

LASEK Alcohol Well
*For retaining alcohol solution
on the corneal epithelium.*

K3-1820 8.5mm diameter

K3-1822 9.5mm diameter



BOTTOM VIEW



Endothelial Stripper

1mm wide, thin beveled tip

K3-1830 smooth surface

K3-1835 Rosenwasser
with textured surface

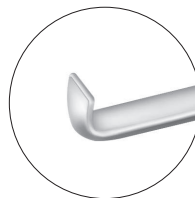

K3-1830

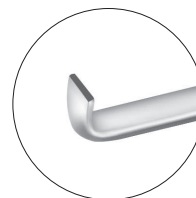

K3-1835



LASEK Spatulas

Sloane

LASEK Micro Hoe
semi-circular tip with
beveled edge
*For lifting the precut margin
of the epithelial flap.*

K3-1840



Sloane

LASEK Epi Peeler
semi-sharp edges
*For peeling and folding back
the epithelial flap.*

K3-1845



Sloane

LASEK Micro Hoe &
Epi Peeler

K3-1848

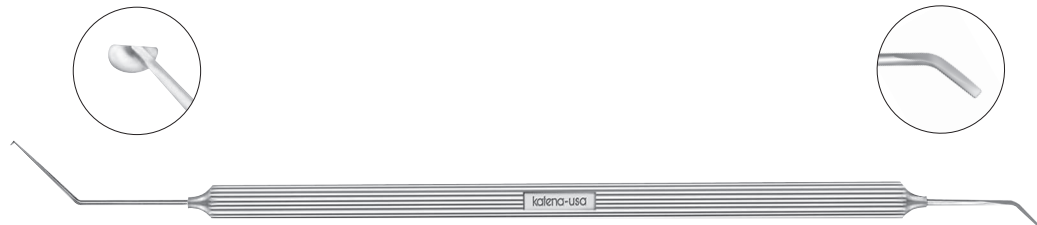

Sloane

LASEK Flap Repositor
gently curved spatulated tip
with beveled smooth edges
*For repositing and smoothing
the epithelial flap after laser
ablation.*

K3-1855



Spatulas

DALK

Corneal Dissector

K3-1870 12mm long, flattened, vaulted spatula with beveled tip

K3-1875 Rosenwasser DALK Trisector with triangular shaft and spatulated tip

K3-1877 Bonfadini DALK Spatula 1mm wide, 8mm long, flattened spatula with central groove for bisecting stroma



K3-1870



K3-1875



K3-1877



Rootman-Goldich

DMEK Dissector
semi-circular tip
with beveled edge
*For atraumatic donor
preparation during
DMEK procedures.*

K3-1880

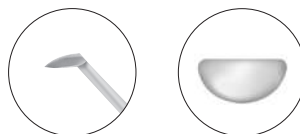

Culler

Iris Spatula

K3-2100 1mm wide

K3-2110 2mm wide



Spatulas • Choppers

Wheeler

Double-End Spatula
lightly curved

K3-2120



Barraquer

Iris Spatula
round, smooth

K3-2300 0.5mm diameter

K3-2310 0.25mm diameter



Katena

Iris Spatula
2mm wide x 8mm long
0.2mm thick

K3-2140



Gimbel

Nucleus Spatula
round, smooth
angled 30° at
10mm from the tip
0.25mm diameter

K3-2312



Alio-Scimitar

MICS Phaco Pre-chopper
curved with blunt tip and
sharp inferior edge
For bimanual nucleus pre-chopping.

K3-2324



Choppers

Phaco Chopper

ball tip
0.7mm inferior wedge
K3-2327



Nagahara

Phaco Chopper
rounded, blunt tip
0.9mm inferior wedge
K3-2329 (shown)
K3-2328 short handle, 100mm



Anis

Phaco Chopper
rounded, blunt, olive tip
offset inferior wedge
K3-2332 for use in right hand
K3-2333 for use in left hand



Chang-Seibel

Phaco Chopper
a combination chopper with the
Chang MicroFinger and the
Seibel Vertical Safety Chopper
K3-2340 for use in right hand
K3-2341 for use in left hand

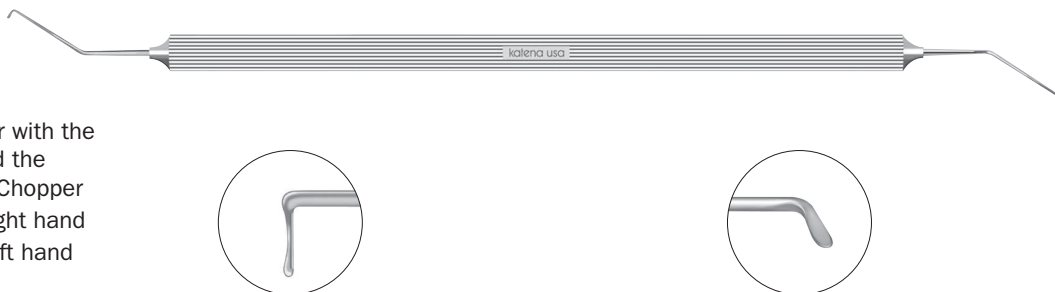

Spatulas • Nucleus Manipulators

Milder

Phaco Chopper
60° offset inferior wedge
for horizontal chopping and
a beveled distal tip for
vertical chopping

K3-2343 for use in left hand



Milder

Phaco Chopper, double-end
60° offset inferior wedge for
horizontal chopping and a beveled
distal tip for vertical chopping.
A 12mm long spatula with a
disc-shaped tip is on the opposite end.

K3-2344 for use in the right hand

K3-2345 for use in the left hand

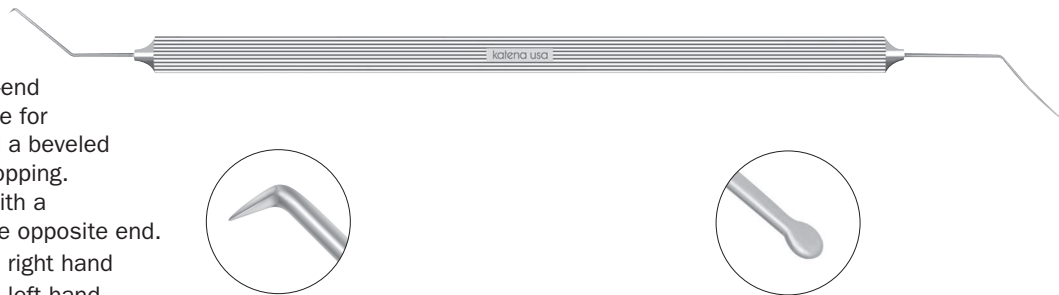

Escaf

Nucleus Manipulator
flattened olive-shaped tip
angled at 45°

K3-2347



Knolle

Nucleus Spatula
malleable stainless steel, flat
0.5mm wide

K3-2350



Nucleus Manipulators



Koch-Nagahara

Karate Chopper
60° offset 1mm cutting wedge
for horizontal chopping and
pointed tip for vertical chopping.
A gently curved duckbill shaped
spatula is on the opposite end.
K3-2352 for use in right hand
K3-2353 for use in left hand



Koch

Nucleus Spatula
gently curved duckbill
shaped tip
K3-2354 smooth
K3-2355 with notches



Akahoshi

Nucleus Sustainer
*Designed to provide
counterpressure when
used with the
Akahoshi PreChopper.*
K3-2357



Nucleus Manipulators

Escaf

Nucleus Sustainer
smooth ball tip
textured inferior surface

K3-2359



Lieberman

MicroFinger
Nucleus Manipulator

K3-2360 for use in right hand

K3-2361 for use in left hand



Lieberman

MicroFinger and Spatula

K3-2362 for use in right hand

K3-2363 for use in left hand



Fukasaku-Lieberman

Phaco Spatula
a combination of the
small pupil snapper hook
and the MicroFinger

K3-2364 for use in right hand

K3-2365 for use in left hand



Nucleus Choppers

Masket

Phaco Spatula
a combination of the Rosen
Phaco Splitter and a 12mm
long round spatula with disc
shaped tip

K3-2367

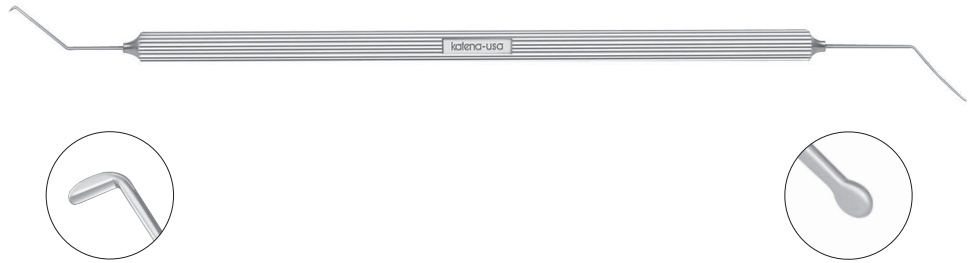

Chang

Phaco Chopper
a combination of a modified
MicroFinger and a 0.9mm long
“Quick Chop” tip

K3-2368 for use in right hand

K3-2369 for use in left hand

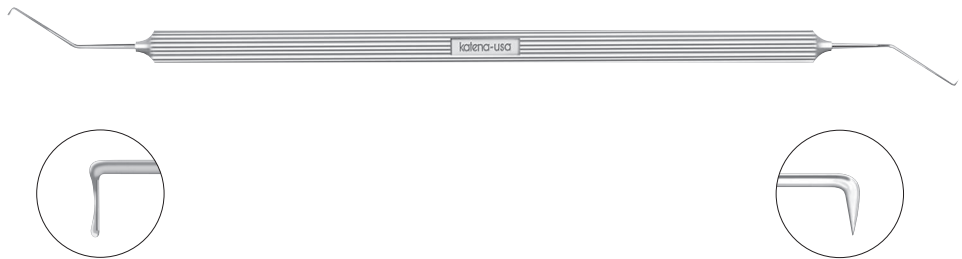

Minardi

Phaco Chopper
0.7mm long
“Quick Chop” tip

K3-2370



Hwang

Phaco Chopper
1mm long
vertical chopper
and a chisel
tipped spatula

K3-2374

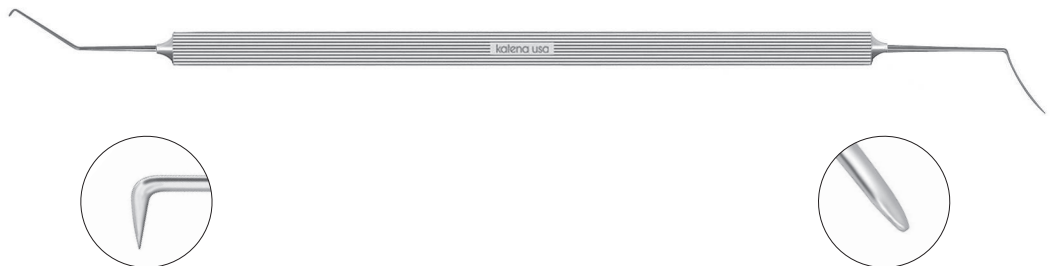

Nucleus Choppers

Agarwal

Karate Phaco Chopper
semi-sharp, wedge shaped
inferior edge with a
pointed tip

K3-2375



Chang

MicroFinger Chopper
curved finger shaped tip
*With defined inner edge
for horizontal chopping.*

K3-2377



Warren

Canine Phaco Chopper
a combination of a 3.5mm
long MicroFinger and a 2mm
long pointed "Quick Chop" tip
For veterinary use only.

K3-2379



Brierley

Nucleus Splitter
1.0mm long tip, angled
with incision sealing shaft

K3-2380



Nucleus Choppers

Dodick-Kammann

Nucleus Chopper

For bimanual nucleus division.

K3-2382 1.5mm long tip,
straight

K3-2383 1.5mm long tip,
angled

K3-2384 2mm long tip,
straight

K3-2385 2mm long tip,
angled



Koch

Nucleus Chopper

1.6mm long with blunted tip

*With rounded surfaces designed
for safely splitting and dividing a
very soft nucleus.*

K3-2386

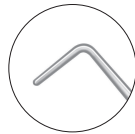

Escaf

Nucleus Divider

1.25mm long

wedge shaped tip

For vertical chopping.

K3-2387



Neuhann

Nucleus Divider

strongly curved spatulated tip

K3-2388



Nucleus Choppers • Manipulators

Nagahara

Nucleus Spatula
flat inferior edge
K3-2390



Fukasaku

wedge shaped inferior edge
K3-2392 Snapper Hook
K3-2393 Small Pupil
Snapper Hook with
notch to engage
the iris



K3-2392

K3-2393



Rosen

Phaco Splitter
wedge-shaped inferior edge
blunt tip

K3-2395 inline wedge, standard
K3-2396 60° offset wedge, for
use in left hand



K3-2395

K3-2396



Rowen

Phaco Spatula
a combination of the
Rosen Phaco Splitter
and the Bechert
Nucleus Rotator
K3-2398



Nucleus Manipulators

Bechert

Nucleus Rotator
blunt forked tip

K3-2400 angled at 7mm

K3-2410 angled at 9mm (not shown)

K3-2411 short handle



K3-2411



K3-2400

Clayman

Nucleus Rotator
0.5mm wide flat spatula
with V-notched tip

K3-2415

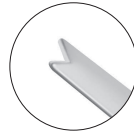

Grayson

Nucleus Manipulator
flattened, smoothly polished
1.1mm long
with "tear-drop" shaped tip

K3-2417

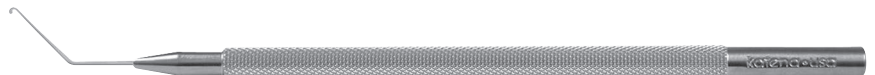

Drysdale

Nucleus Manipulator
paddle shaped tip

K3-2418 rounded edges

K3-2419 defined anterior edge
for capsule polishing



K3-2418

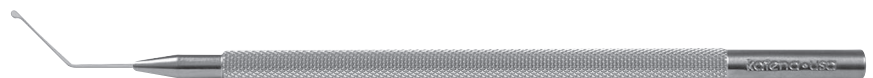

Spatulas

Pisacano

Nucleus Rotator
flat disc shaped tip
K3-2420 horizontal
K3-2421 vertical



horizontal

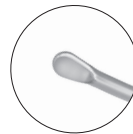

vertical

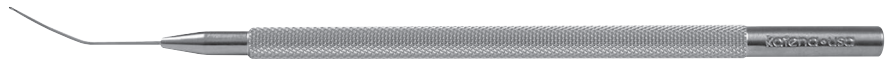

Siepsier

Endocapsular Controller
trumpet shaped tip
K3-2425



Anis

Nucleus Manipulator
with 0.5mm diameter ball tip
K3-2426 straight
KT3-2426 straight, titanium
K3-2427 angled (shown)
KT3-2427 angled, titanium

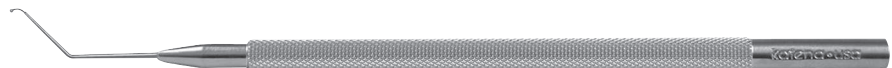
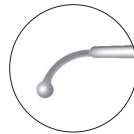

Tennant

Nucleus Rotator
with 0.6mm diameter
ball shaped tip
K3-2428

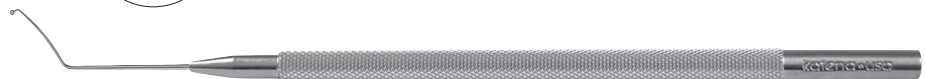
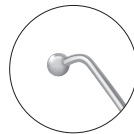

Femto Spatulas

Lippman

Nucleus Spatula
0.5mm diameter round
shaft with blunt forked tip

K3-2430



Donnenfeld

Femto Spatula
1mm long x 0.3mm wide
flattened tip

K3-2440 pointed

K3-2442 blunt

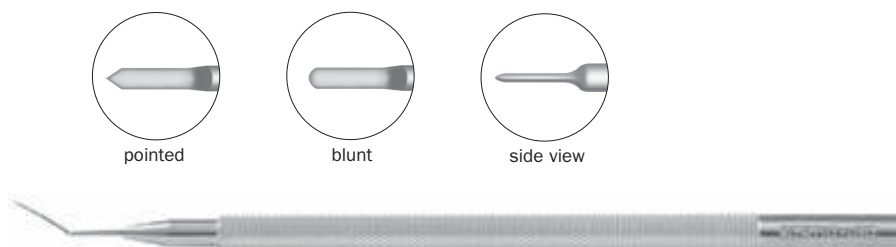

Donnenfeld

Femto Splitter
paracentral curve in shaft

K3-2450 right (shown)

K3-2451 left

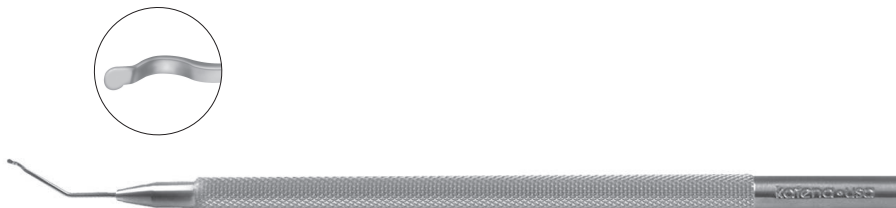

Katena

Femto Spatula
double-ended with blunt tips
1mm long x 0.3mm wide
flattened spatula and
2mm wide keratome-shaped tip

K3-2460



Spatulas

Girard

Synechiaie Spatula
0.5mm wide with
semi-sharp tip

K3-2500

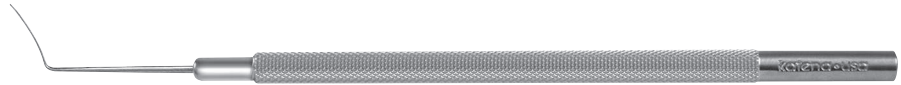

Obstbaum

Synechiaie Spatula
0.25mm wide with
semi-sharp tip

K3-2520



Benedetto

IntraLase® Spatula
10mm long, smoothly
polished flattened spatula
with beveled notches

K3-2522



Moran

LASIK Enhancement Spatula
Fukasaku spatula
and a modified Paton
spatula

K3-2524



LASIK Spatulas

Hersh

IntraLase® Flap Spatula
beveled tips
a combination of a
6mm spatula and
a 10mm spatula

K3-2526

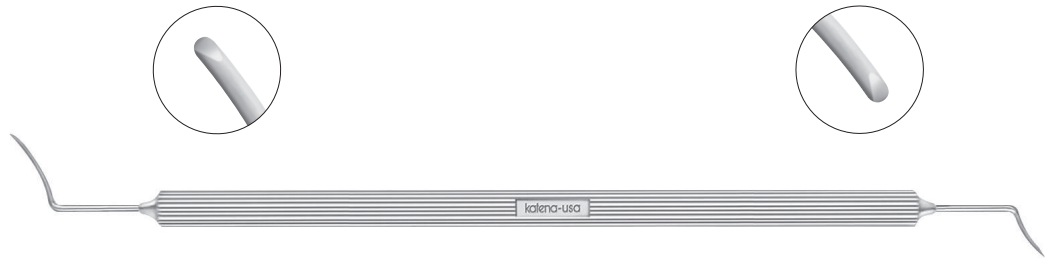

Binder

IntraLase® Flap Elevator
1mm wide
12mm long
semi-sharp edges

K3-2528



Fukasaku

LASIK Spatula
rounded anterior and
flat posterior surface
with beveled tip
*For lifting and dissecting
the corneal flap.*

K3-2530



Guimaraes

LASIK Spatula
gently curved, bi-convex
semi-sharp edges

K3-2532



LASIK Spatulas

Katzen

LASIK Flap “Unzipper” combines a modified Sinsky Hook and a bi-convex spatula with beveled notches
For LASIK enhancements.

K3-2534

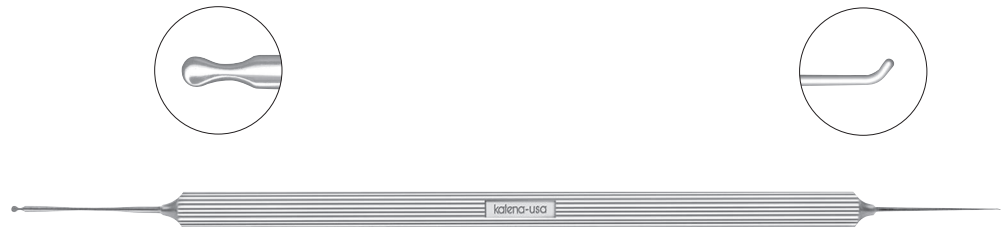

Maddox

LASIK Spatula combines a flat spatula and a cylindrical spatula
For elevating and repositing the flap.

K3-2535



Thorlakson

Z-LASIK™ Flap Lifter combines a modified Sinsky Hook and a bi-convex spatula with beveled notches

K3-2536 long handle

K3-2537 short handle



LASIK Flap Lifter

Combines a 45° angled Sinsky Hook and a thin hook with a conical tip

K3-2538

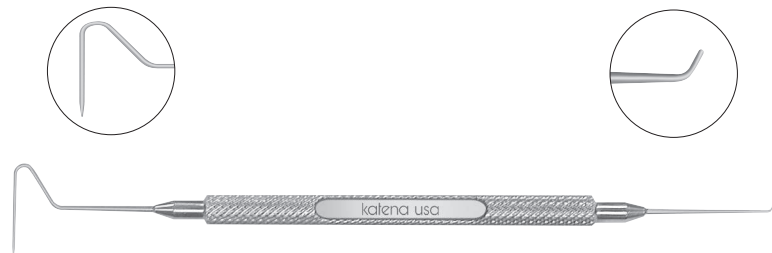

IOL Manipulators

SMILE Spatula

Combination instrument for opening the incision and dissecting the pocket during SMILE procedures.

K3-2542

(use K5-7550 for removing lenticule)



side view



top view



Hirschman

Lens Spatula
flat 0.5mm wide
with multiple notches

K3-2550



Jaffe

Lens Spatula
flat, 0.5mm wide

K3-2600



Labor

IOL Manipulator
short handle
*For use with intra-operative
aberrometry systems.*

K3-2675



IOL Manipulators

Lester

IOL Manipulator
0.25mm diameter tip
Ideal for multi-directional manipulation.

K3-2680 straight, with guard

K3-2690 angled



Lester

IOL Manipulator
0.25mm diameter tip
vaulted shank
For engaging the inferior haptic without touching the dome of the IOL.

K3-2691

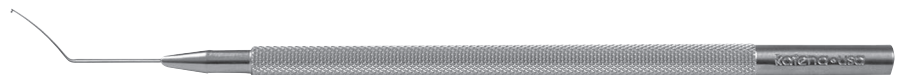

Maloney

IOL Manipulator
0.25mm diameter tip
vaulted shank
with guard

K3-2692



Hunkeler

IOL Manipulator
with 0.3mm diameter
hemi-ball tip, vaulted shank

K3-2695



IOL Manipulators

Alio-Kelman

IOL Hook
0.2mm diameter tip
K3-2697



Aker

Lens Pusher
smooth, fish mouth
shaped tip
with guard
K3-2720



Bechert

Lens Pusher
vertical Y-shaped tip
angled
K3-2727

(for horizontal version see K3-2400)



Elschnig

Cyclodialysis Spatula
flat, 1mm wide
K3-3000



Cyclodialysis Spatulas

Castroviejo

Synechiaie Spatula
0.5mm wide with
semi-sharp tips
K3-3150

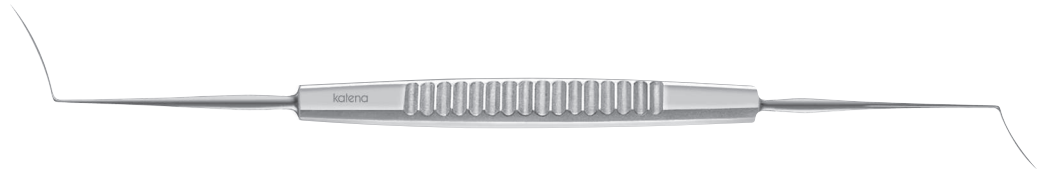

Castroviejo

Cyclodialysis Spatula
K3-3200 0.25mm wide
K3-3210 0.5mm wide

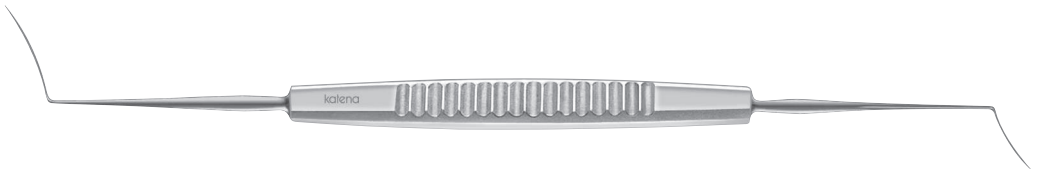

Labor

Cyclodialysis Spatula
slightly vaulted
0.5mm wide, angled 5mm
*For use with intra-operative
aberrometry systems.*
K3-3212



Kimura

Platinum Spatula
K3-3500



Lens Loops

Keener

Lens Divider
with three
preformed
snare wire loops

K3-3900 complete

K3-3910 wire loops (pk/3)

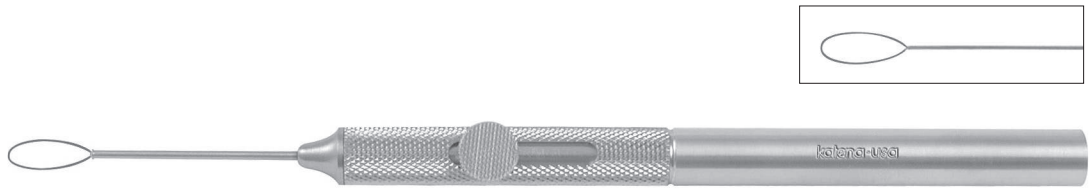

Lens Loop

K3-4000 Lewis, small

K3-4010 Lewis, large

K3-4030 New Orleans

K3-4100 Wilder, serrated



K3-4000



K3-4030



K3-4100



K3-4010

Kirby

Lens Loop and
Muscle Hook

K3-4105



Morrison

Lens Loop and Probe

K3-4120



Manual Nucleus Fragmentation

Lens Loop

serrated, 3mm wide

K3-4140 Kansas,
light curve

K3-4141 Keener-Arlt,
strong curve



Alfonso

Nucleus Trisector

1.5mm wide

(used with K3-4156

Alfonso Cutting Platform)

For manual small incision surgery.

K3-4145

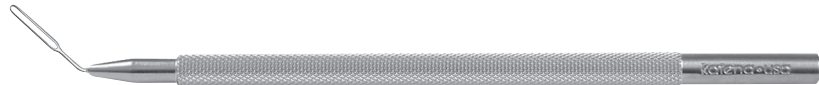

Bucher-Kansas

Nucleus Trisector

2.5mm wide

(used with K3-4157

Alfonso Cutting Platform)

K3-4146



Kansas

Nucleus Trisector

4mm wide

(used with K3-4152

Kansas Vectis)

K3-4148



Manual Nucleus Fragmentation

Kansas

Nucleus Bisector

K3-4150

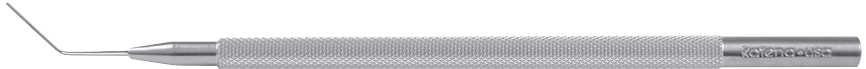

Kansas

Nucleus Vectis

Used as a cutting block for
nucleus bisector or trisector.

K3-4152



Alfonso

Cutting Platform

Used as a cutting block for
nucleus trisector.

For manual small incision surgery.

K3-4156 2mm wide (used with K3-4145)

K3-4157 3mm wide (used with K3-4146)



Culler

Lens Spoon
sterling silver

K3-4200



Spoons and Spatulas

Paton

Spatula & Spoon
For corneal button
transfer.

K3-4255



Rosenwasser

Lamella Donor Shovel
with retaining rim on 3 sides
For atraumatic insertion
of the donor lamella.

K3-4263 5mm wide



Endothelial Glide

funnel-shaped spatula
cut-out notch at tip
(used with K5-7550)

K3-4270

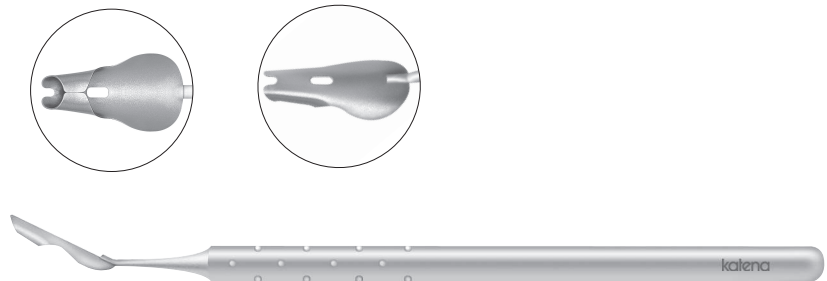

Bunge

Evisceration Spoon

K3-4400 small

K3-4410 large



Spoons and Iris Retractors

Wells

Enucleation
Spoon
K3-4450



Graether

Collar Button
micro iris retractor
K3-4900 straight, with guard
K3-4910 angled



Graether

Irrigating Collar Button
micro iris retractor and
posterior capsule polisher
K3-4920 straight
K3-4930 angled



Iris Retractors and Hooks

Keuch

Small Pupil Dilator
with guard
*For enlarging a small pupil
through the sideport and
primary incision.*

K3-4950



Iris Retractors

six 10mm long flexible hooks
in an autoclavable case
reusable

K3-4970

*(also available
sterile/disposable
K20-3890 & K20-3892)*



Reversed Sinskey Hook

0.2mm diameter blunt tip
*For scoring the recipient
endothelium and positioning the
donor lamella.*

K3-5002



Hooks

Bonn

Micro Iris Hook
extra delicate
blunt, round handle
with guard

K3-5050

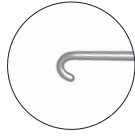

Bonn

Micro Iris Hook
blunt, flat handle

K3-5060



Shepard

Iris Hook
blunt

K3-5110

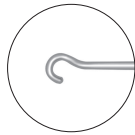

Lens Manipulating Hook

0.15mm diameter blunt tip

K3-5160 Jaffe, straight

K3-5170 Clayman-Jaffe, angled



IOL Manipulators

Sinskey

Lens Manipulating Hook
0.25mm diameter blunt tip
straight

K3-5180



Harris-Sinskey

Lens Manipulating Hook
0.25mm diameter blunt tip
angled

K3-5190



Sinskey

Lens Manipulating Hook
round handle
0.25mm diameter blunt tip
K3-5192 straight, with guard
K3-5193 angled

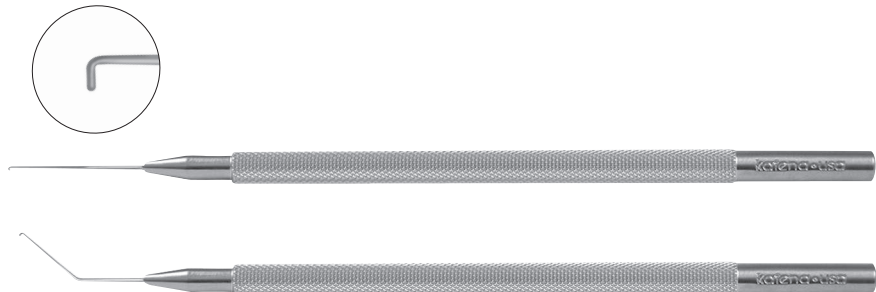

Nevyas

Soft IOL Manipulator
0.25mm diameter
textured tip
straight, with guard

K3-5194



IOL Manipulators

Sinskey II

Lens Manipulating Hook
0.2mm diameter blunt tip

K3-5220 straight

K3-5230 angled



Sinskey II

Lens Manipulating Hook
0.2mm diameter blunt tip
round handle

K3-5232 straight, with guard

K3-5233 angled

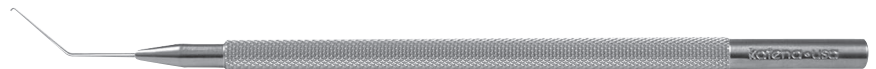

Lewicky

Lens Manipulating Hook
0.15mm diameter blunt tip
angled, vaulted shank

K3-5250

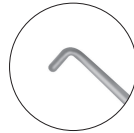

Hirschman

Iris Hook
blunt, angled

K3-5400

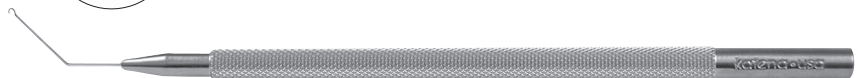

IOL Manipulators and Iris Hooks

Kuglen Iris Hook & Lens Manipulator

K3-5500 Push-pull model,
flat handle, straight

K3-5520 Push-pull model,
flat handle, angled

K3-5510 Clover leaf model,
flat handle, straight

K3-5522 Push-pull model,
round handle,
straight w/guard

K3-5523 Push-pull model,
round handle, angled

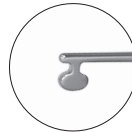

K3-5500
K3-5520

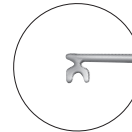

K3-5510



K3-5522
K3-5523



Lens Manipulator

straight, with guard

K3-5526 Rentsch, "Boat Hook"

K3-5528 Osher, Y-hook

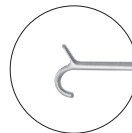

K3-5526



K3-5528



Lens Manipulating Hook

0.15mm diameter tip

K3-5530 Fenzl, round handle
straight with guard

K3-5531 Fenzl, round handle,
angled

K3-5532 Maltzman-Fenzl,
round handle,
straight with guard

K3-5533 Maltzman-Fenzl,
round handle,
angled

K3-5535 Jaffe-Maltzman,
flat handle, angled



K3-5530
K3-5531



K3-5532
K3-5533



K3-5535

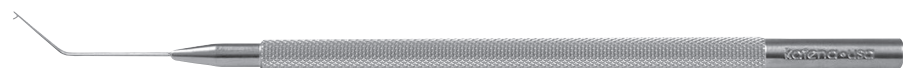

ICL Manipulators

Clasen

ICL™ Manipulator
with textured hemi-ball tip

K3-5564



Deitz

ICL™ Manipulator
blunt forked tip

K3-5566



Ichikawa

ICL™ Manipulator
delicate ring tips
with micro texturing
on posterior surfaces

K3-5568



Fixation Hooks

B. H. Kim

Intraocular Mirror
highly reflective 2.5mm disc
angled at 10mm
For intraocular visual
inspection.

K3-5580



Fixation Hook

double, sharp

K3-6000 small

K3-6010 large



Twist Hook

for scleral fixation

K3-6100 right

K3-6110 left



Silverman

Fixation Pick
blunt cone shaped tips
spaced 3mm apart

For atraumatic scleral fixation.

K3-6130



Fixation Rings

Katena

Globe Fixation Ring
with concentric grooves
12mm I.D.

K3-6153 for refractive procedures

K3-6154 for cataract procedures

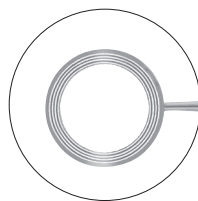

K3-6153
bottom



K3-6154
top

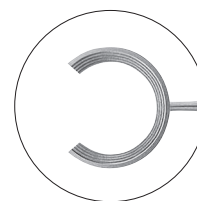

K3-6154
bottom



K3-6153

Lu-Mendez

LRI Guide and Fixation Ring
marked in 10° increments
with delicate blunt teeth
11mm I.D.

K3-6158



Gimbel

Stabilization Ring
with swivel handle
13mm diameter with blunt teeth
on both sides

*For stabilizing either the right or
left eye during LASIK.*

K3-6160



Fixation Rings

Fine-Thornton

Swivel Fixation Ring
conical teeth
Features marks on anterior
surface in 15° increments
as a guide for placement of
limbal relaxing incisions.

- K3-6161** 13mm diameter
- K3-6163** 16mm diameter
- K3-6171** 13mm diameter
short handle

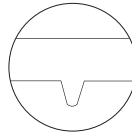

conical teeth



Fine-Thornton

Swivel Fixation Ring
flattened teeth

- K3-6162** 13mm diameter

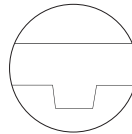

flattened teeth



Thornton

Globe Fixation Ring
multiple blunt teeth
16mm diameter ring

- K3-6165**



Muscle Hooks

Hofmann-Thornton

Globe Fixation Ring
with swivel handle
16mm diameter ring
multiple blunt teeth

K3-6168



Stevens

Tenotomy Hook
blunt, small

K3-6600



Helveston

"Teaser" Hook
extra delicate, blunt

K3-6610



Graefe

Muscle Hook

K3-6710 size 1

K3-6720 size 2

K3-6730 size 3

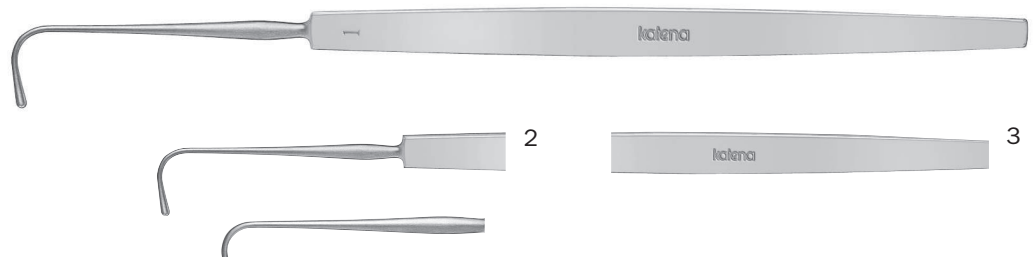

Muscle Hooks

Gass

Retinal Detachment Hook
with oval hole

K3-6740



Helveston

Finder Hook
extra delicate with lightly
angled cone shaped tip

K3-6760 large

K3-6761 small



Helveston

Muscle Hook
extra delicate, with blunt
spatulated tip

K3-6778 8mm

K3-6780 10mm

K3-6782 12mm



Muscle Hooks

Jameson

Muscle Hook
K3-6800 small
K3-6810 large (shown)



Du Plessis

Muscle Hook
 double arm
K3-6814



Guyton

Small Incision
 Muscle Hook
K3-6820



Rychwalski

Double-Groove Muscle Hook
*For use on tight
 rectus muscles.*
K3-6830

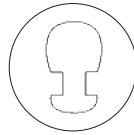

front view



Green

Muscle Hook
K3-6850



Corneal Markers

Bishop

Muscle Hook
with rotatable
protective plate
*For use on tight
rectus muscles.*

K3-6854



Corneal Marker

for LASIK surgery
*For identification and
realignment of
the lamellar flap.*

K3-7720 Mendez

K3-7730 Chayet

K3-7737 Dulaney

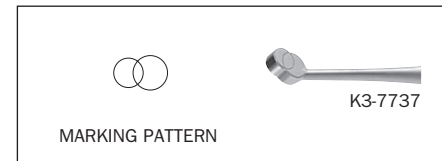
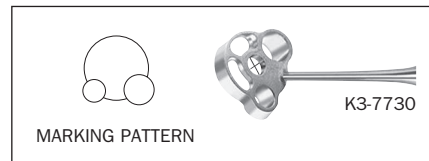

Kellen

Capsulorrhexis Marker
central ring with non-marking
posts for alignment with limbus

K3-7850 6mm diameter marking ring
(for 5.5mm CCC)

K3-7852 5.5mm diameter marking
ring (for 5.0mm CCC)



Corneal Markers

Maloney

Intra-Operative Keratometer
titanium
For qualitative measurement
of astigmatism.

K3-7888

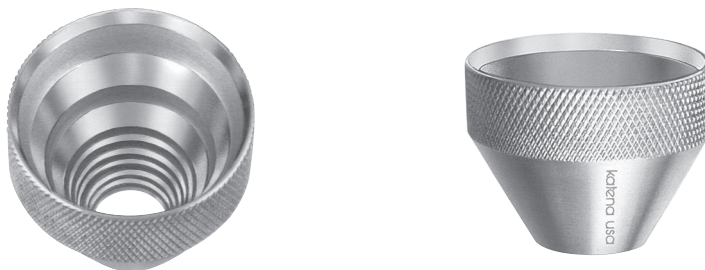

Mendez

Degree Gauge
12mm I.D.
marked in 10° increments
titanium
For accurate axial
alignment on the cornea.

K3-7900



Bores

Axis Marker
(used with K3-7900 Mendez
degree gauge)

K3-7910



Lindstrom

Arcuate Incision Marker
(used with K3-7900 Mendez
degree gauge)

K3-7996 7mm optic zone



MARKING PATTERN



Corneal Markers

Henderson

Degree Gauge

11.7mm I.D.

Beveled face with markings
in 5° increments

4 notches on internal edge
to align with cardinal positions
titanium

K3-7904

K3-7905 with blunt teeth
for fixation

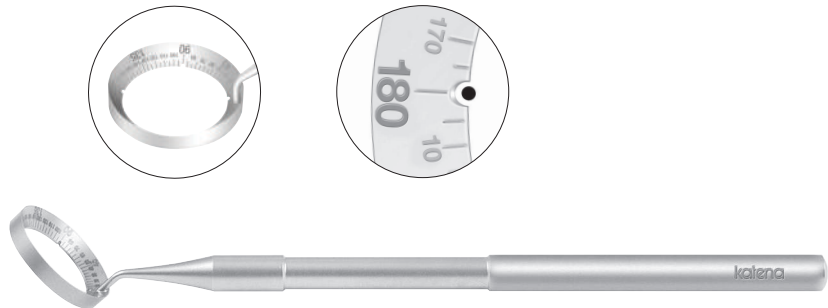

Bubble

Alignment Marker
with bubble level

*For determining and marking
the horizontal axis.*

K3-7906

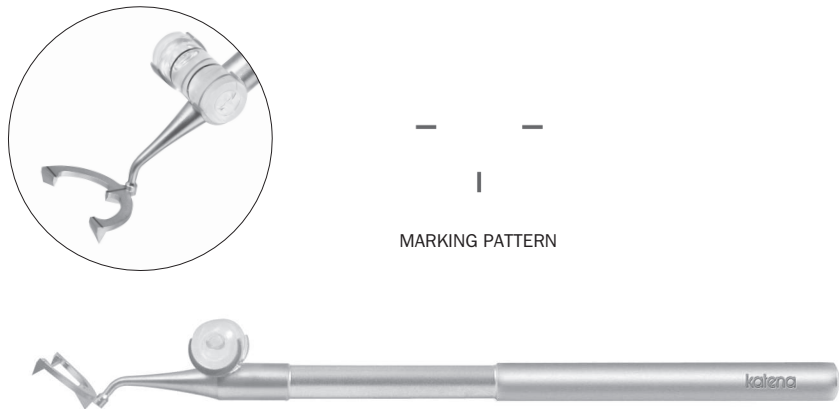

Henderson

Alignment Marker

with atraumatic
disc-shaped marking
surfaces at 3, 6 & 9 o'clock
titanium

*(used with K3-7904
or K3-7905)*

K3-7908

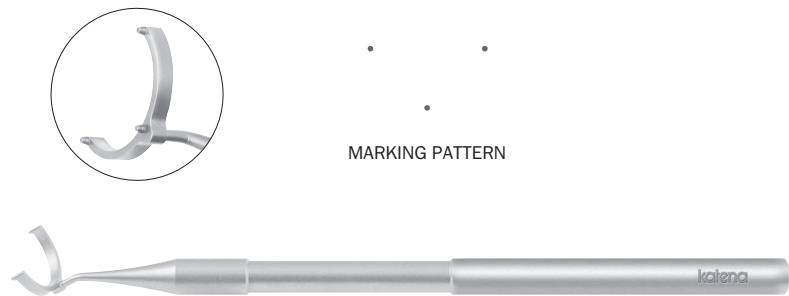

Corneal Markers

Henderson

Toric IOL Marker
two 2.5mm radial
marks extending to 11mm
titanium
(used with K3-7904 or K3-7905)

K3-7912

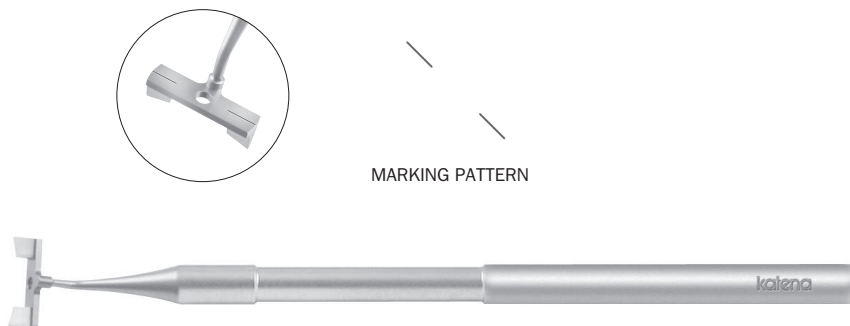

Chu

LRI Marker
rotating degree gauge
with 30°, 45° and 60° landmarks

K3-7930

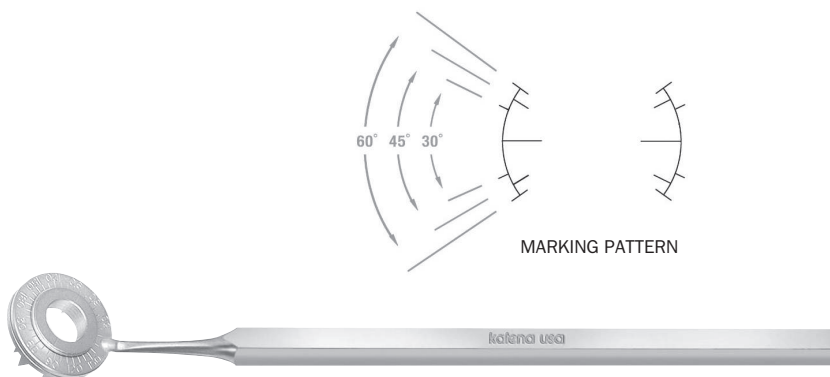

Henderson

Limbal Relaxing Incision Marker
with 30°, 45° and 60° landmarks
(used with K3-7904 or K3-7905)

K3-7936

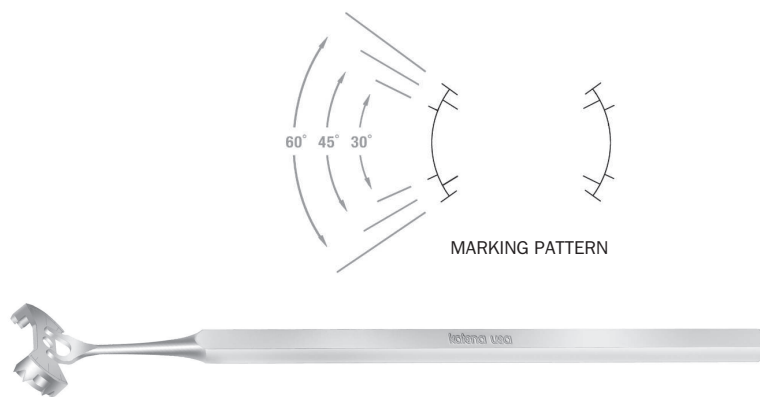

Corneal Markers

Optic Zone Markers

Bores

K3-8130	3.0mm
K3-8131	3.25mm
K3-8132	3.5mm
K3-8133	3.75mm
K3-8134	4.0mm
K3-8135	4.25mm
K3-8136	4.5mm
K3-8137	4.75mm
K3-8138	5.0mm
K3-8142	6.0mm
K3-8146	7.0mm
K3-8148	7.5mm
K3-8150	8.0mm
K3-8152	8.5mm
K3-8154	9.0mm

Hoffer, with cross hairs

K3-8330	3.0mm
K3-8340	3.25mm
K3-8350	3.5mm
K3-8360	3.75mm
K3-8370	4.0mm
K3-8380	4.25mm
K3-8390	4.5mm
K3-8400	4.75mm
K3-8410	5.0mm
K3-8412	5.5mm
K3-8414	6.0mm
K3-8418	7.0mm
K3-8422	8.0mm
K3-8426	9.0mm



Anis

Radial Marker
4mm diameter
center opening
12.5mm O.D.

K3-8852	8 blades
K3-8854	12 blades (shown)
K3-8855	16 blades



Markers

Anis

Suture Placement Marker
 8 radial blades
 8mm diameter center opening
For corneal grafts.

K3-8862



Fechtner

Trabeculectomy Marker
K3-8975



MARKING PATTERN



Fechtner

EX-PRESS® Marker
 U-shaped 2.75mm marking
 pattern. Side landmarks to help
 identify the insertion site.

K3-8977



MARKING PATTERN



EX-PRESS® is a registered trademark of Alcon.



Calipers

Castroviejo

Caliper

20mm spread

K3-9000 straight

K3-9002 angled

K3-9010 curved



Osher

Incision Caliper

For internal measurement
of cataract incisions from
1 to 10mm.

K3-9012



Helveston

Scleral Ruler

15mm long, with notches
in 5mm increments

single marking tooth at tip

For measuring and marking
the distance from the limbus
to the location of the muscle
reinsertion.

K3-9030

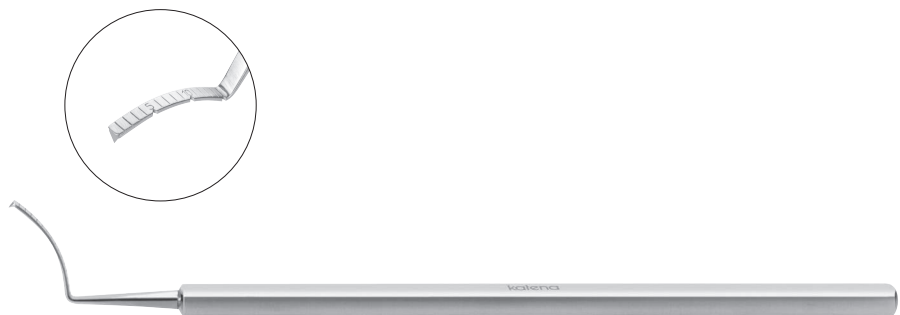

Calipers

Jameson

Caliper
chrome plated brass
K3-9150

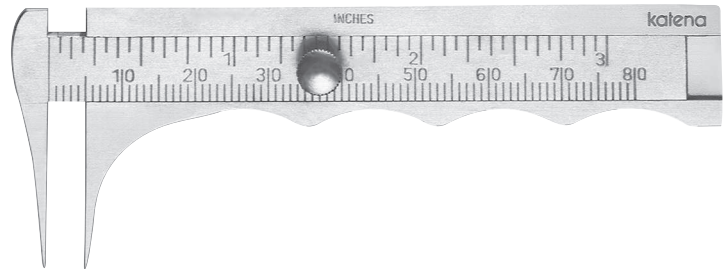

Ruler

Stainless Steel
inches and mm
K3-9200

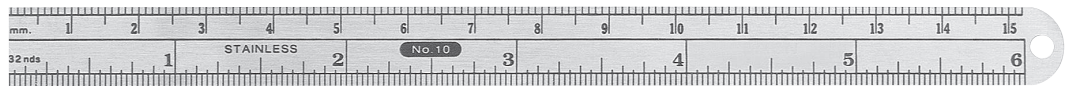

reduced by 10%

Braunstein

Caliper
stainless steel
K3-9240 3.0/3.5mm
K3-9250 3.5/4.0mm

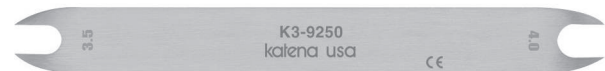

Stahl

Corneal Caliper
with size markings on both sides
*For measuring corneal diameter
"white to white".*

K3-9300 0.5mm and 1.0mm sizes
from 10.0 to 13mm

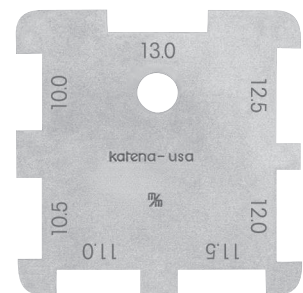

Scissors

Castroviejo

Corneoscleral Scissors
small blades

K4-1000 right (shown)

K4-1010 left

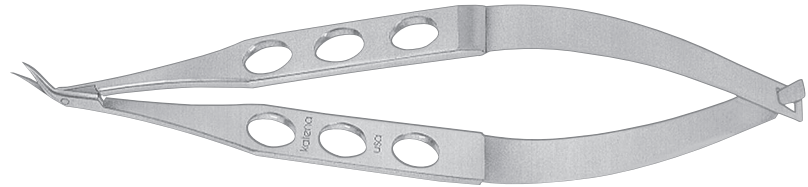

Castroviejo

Corneoscleral Scissors
medium blades

K4-1020 right (shown)

K4-1030 left



Troutman-Castroviejo

Corneoscleral Scissors
with stop, small blades

K4-1200 right (shown)

K4-1210 left

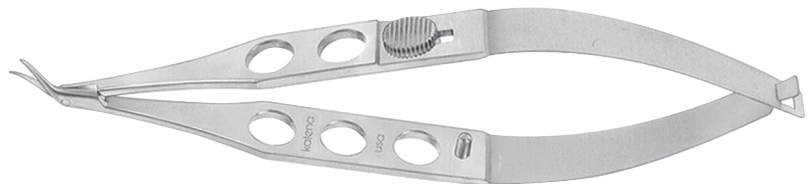

Scissors

Troutman-Castroviejo

Corneoscleral Scissors
with stop, medium blades

K4-1220 right

K4-1230 left (shown)



Troutman-Katzin

Corneal Transplant Scissors
with stop
strong curve, small blades

K4-2000 right

K4-2010 left (shown)

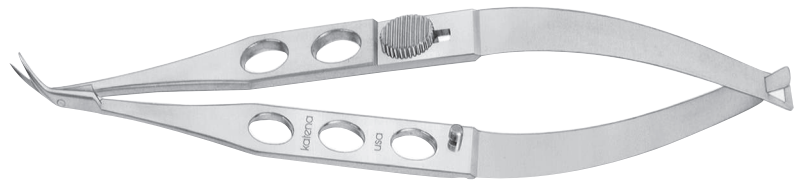

Rich

Corneal Transplant Scissors
extremely delicate,
strongly curved blades
*For trimming the recipient corneal
bed and donor button.
Can also be used for open sky
anterior capsulotomy.*

K4-2014 right

K4-2015 left (shown)



Scissors

Terry

Micro Corneal Scissors
round handle
for meticulous control

K4-2016 right (shown)

K4-2017 left

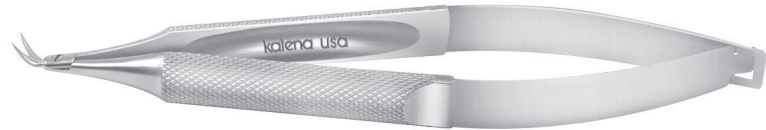

Holland

DALK Scissors
spatulated tip

K4-2018 right (shown)

K4-2019 left



Katzin

Corneal Transplant Scissors
strong curve, medium blades

K4-2020 right

K4-2030 left (shown)



Scissors

Castroviejo

Universal Corneal Scissors
curved, blunt tips

- K4-2200** small blades
- K4-2220** medium blades
- K4-2240** large blades
- K4-2260** strongly curved large blades

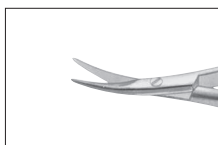

K4-2220

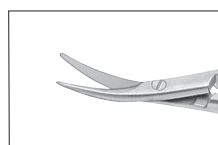

K4-2240



K4-2260

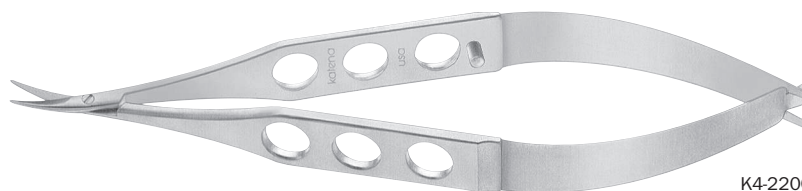

K4-2200

Castroviejo

Keratoplasty Scissors
angled to side
blunt tips, medium blades

K4-2850



McPherson-Westcott

Conjunctival Scissors
curved
blunt tips, small blades

K4-3000

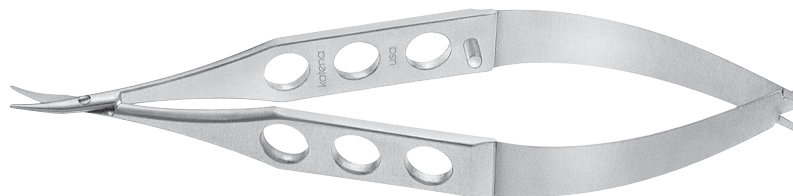

Scissors

Sarkisian-Westcott

Scissors
small blades
with nine 1mm landmarks
laser etched on one blade
*For intra-operative cutting and
measuring with a single instrument.*

K4-3002

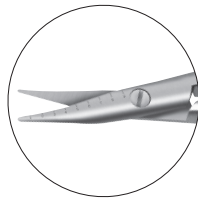

Westcott

Tenotomy Scissors
blunt tips, medium blades
curved

K4-3004

Westcott

Tenotomy Scissors
blunt tips, standard blades
curved

K4-3100 right (shown)

K4-3110 left



Scissors

Tibolt

Punctal Scissors
one conically shaped blade
with micro grooves and
textured surface
*For simple "Two-snip
Punctoplasty".*

K4-3130



Mini Westcott

Tenotomy Scissors
4mm long curved blades
blunt tips

K4-3200

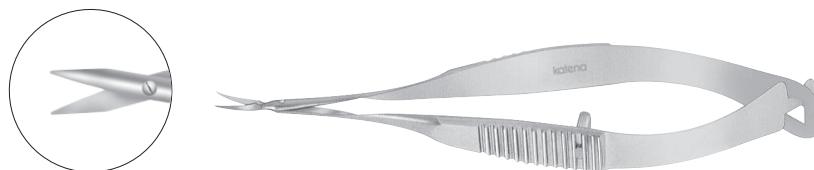

McPherson-Westcott

Stitch Scissors
very sharp pointed tips
small blades
curved

K4-4000

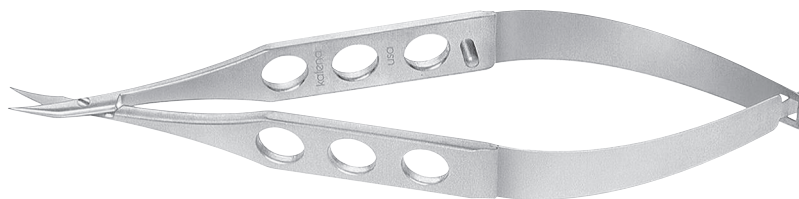

Scissors

Westcott

Stitch Scissors
 very sharp pointed tips
 standard blades
 curved
K4-4100



Jaffe

Stitch Scissors
 very sharp pointed tips
 medium blades
 curved
K4-4150

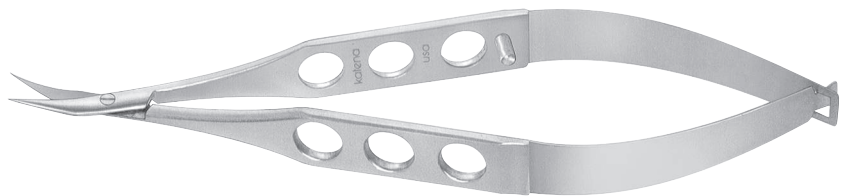

Katena

Micro Tying Scissors
 For tying and cutting
 9-0 to 11-0 sutures.
 2.75mm long tying platform
*Not to be used as a
 needle driver.*
K4-4200

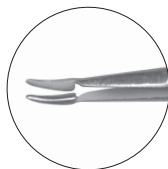

side view



Scissors

Iris

Scissors
sharp tips, small blades

K4-4400 straight

K4-4410 curved

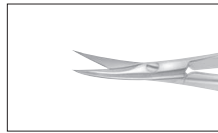

K4-4410



Fine

Stitch Scissors
sharp tips, medium blades

K4-4500 straight

K4-4510 curved



K4-4510



Barraquer

Iris Scissors
blunt tips, 7mm long blades

K4-4900



Capsulotomy Scissors

Capsulotomy Scissors

Vannas

5mm long blades, sharp tips

K4-5000 straight

K4-5010 curved

K4-5020 angled forward

K4-5030 angled to side



K4-5000

Gills-Vannas

7mm long blades, sharp tips

K4-5050 straight

K4-5060 curved

K4-5070 angled forward

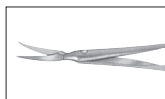

K4-5010

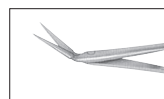

K4-5020



K4-5030



K4-5050

Holland DALK Scissors

4.5mm angled blades

K4-5075 blunted tips



K4-5060



K4-5070



K4-5075

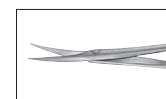

K4-5100

McPherson-Vannas

8mm long blades, sharp tips

K4-5100 curved

Capsulotomy Scissors

Katena-Vannas

7mm extra thin long blades, sharp tips

K4-5110 Katena-Vannas, straight

K4-5111 Katena-Vannas, curved

K4-5112 Gills-Vannas, angled forward



K4-5110

10mm extra thin long blades, sharp tips

K4-5120 Katena-Vannas, straight

K4-5121 Katena-Vannas, curved

K4-5122 Stern-Gills, angled forward

K4-5123 Uribe-Stern, curved,
angled, forward

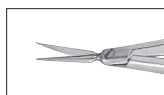

K4-5111

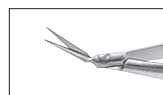

K4-5112

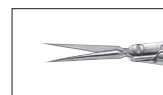

K4-5120



K4-5121

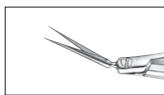

K4-5122



K4-5123



K4-5125



K4-5126

10mm long angled blades, curved tips

K4-5125 Gills, sharp points

K4-5126 Uthoff-Gills, blunt points

Scissors

Vitreotomy Scissors

20 gauge shank
Stainless steel construction with serrated plastic handle. Autoclavable.

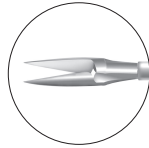
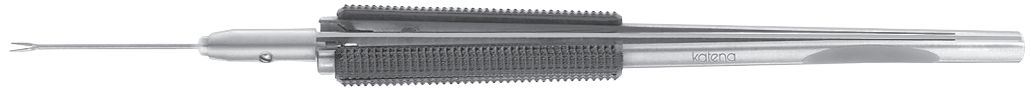

Scissors
horizontal opening
straight
K4-5200

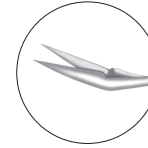

Scissors
horizontal opening
angled 30°
K4-5210

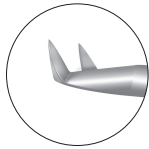

Scissors
vertical opening
angled 60°
K4-5240

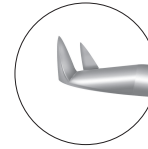

Scissors
vertical opening
angled 80°
K4-5250



Katena

“Squeeze Handle” Scissors
These “squeeze handle” instruments feature titanium handles to reduce overall weight, and front ends of hardened stainless steel for secure cutting.



Scissors
horizontal, straight
K4-5300 20ga.



Scissors
horizontal, curved
K4-5310 20ga.
K4-5423 23ga.
K4-5425 25ga.



Scissors
horizontal, angled 45°
K4-5320 20ga.



Scissors
vertical, 40°
K4-5330 20ga.



Scissors
vertical
K4-5433 23ga.



Scissors
vertical, 80°
K4-5340 20ga.

Scissors

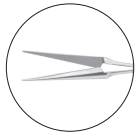

Alio

MICS Scissors

23 gauge curved shaft with
horizontal micro blades

For cutting delicate membranes.

K4-5351

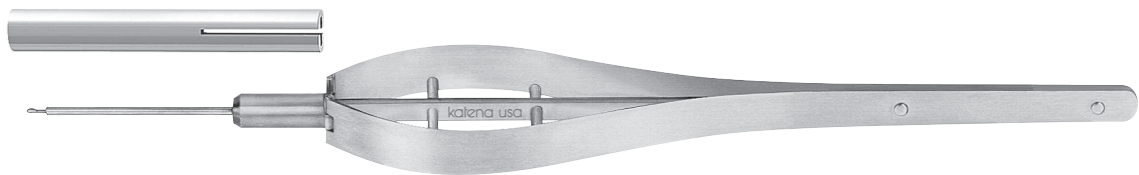
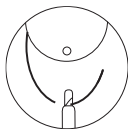

Scimeca

Lens Loop Amputator

*For cutting polypropylene
or PMMA lens haptics
in the anterior or posterior
chamber.*

K4-5550 with guard

IOL Cutters

Donnenfeld

Micro IOL Cutter
4mm long blades
micro notches in
blades for traction
*For cutting soft IOLs
through a 1.5mm incision.*

K4-5560

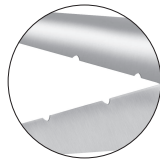

Used with K5-7570

Stolte

IOL Cutter
titanium
slotted cover to retain
soft IOL during cutting
process
For cutting soft IOLs.

K4-5565

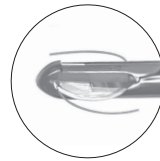
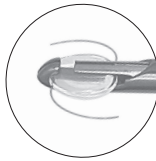
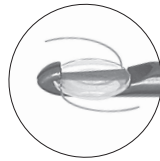

Katena

IOL Cutter
6mm long serrated blades
For cutting soft IOLs.

K4-5571

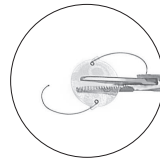
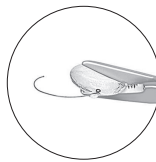

Scissors

Eye Scissors

pointed tips

small

K4-7200 straight

K4-7210 curved



Eye Scissors

pointed tips

standard

K4-7400 straight

K4-7410 curved



Eye Scissors

large rings

pointed tips

standard

K4-7440 straight

K4-7450 curved



Scissors

Stitch Scissors

ribbon type
needle points
curved
K4-8000

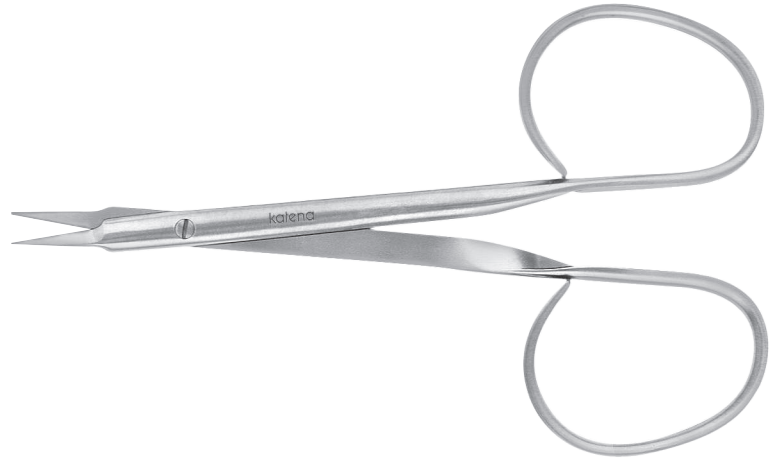

Stitch Scissors

needle points
light curve
K4-8100



Scissors

Stevens

Tenotomy Scissors
blunt tips
standard

K4-8500 straight

K4-8510 curved



Stevens

Tenotomy Scissors
ribbon type
blunt tips

K4-8520 straight

K4-8530 curved



Knapp

Strabismus Scissors
blunt tips

K4-9000 straight

K4-9010 curved



Scissors

Strabismus Scissors

ribbon type

blunt tips

K4-9020 straight

K4-9030 curved

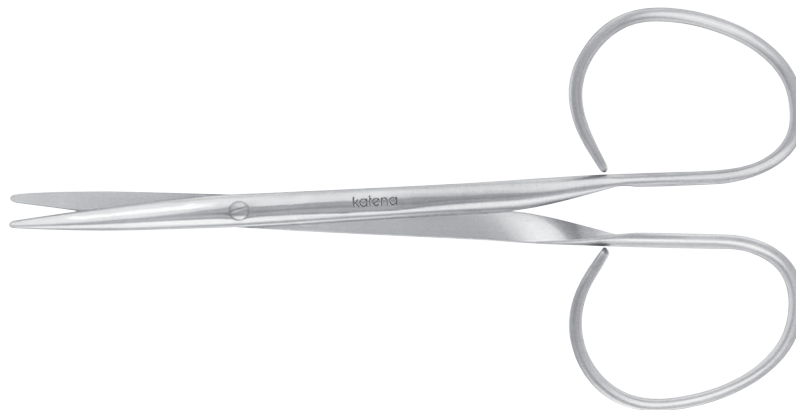

Metzenbaum

Dissecting Scissors
gently curved blades

blunt tips

5¾" (14.5cm) long

K4-9040



Scissors

Utility Scissors

one pointed and one
blunt tip
5¾" (14.5cm) long
straight

K4-9060



Enucleation Scissors

blunt tips

K4-9910 medium curve

K4-9920 strong curve



Forceps

Botvin

Iris Forceps

For peripheral iridectomies.

K5-1040 serrated tips

K5-1050 1x2 teeth



Gills-Colibri

Tissue Forceps

very fine pointed tips

with tying platform

K5-1450



Colibri Style

Tissue Forceps

very delicate, 1x2 teeth, 0.12mm

K5-1500 Colibri

K5-1520 Harms-Colibri, with tying platform

KT5-1520 Harms-Colibri, titanium, with tying platform

K5-1522 Dyson-Colibri, short tips, extremely thin shanks, with tying platform



Standard, 1x2 teeth with tying platform

K5-1550 Colibri, 0.4mm

Corneal Suturing Forceps

very delicate, 1mm spread, 1x2 teeth, 0.12mm

K5-1560 Polack

Corneal Forceps

very delicate, 1x1 teeth, 0.1mm

K5-1700 Pierser-Colibri



K5-1500



K5-1520

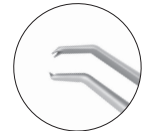

K5-1522



K5-1550



K5-1560

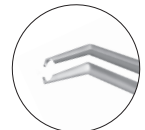

K5-1700

Forceps

Hofmann-Polack

Corneal Suturing Forceps
with guide pin
1mm spread
1x1 teeth, 0.2mm

K5-1566

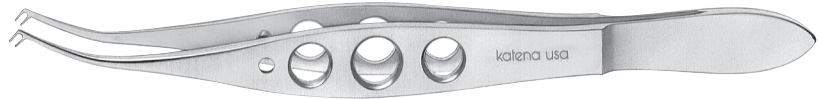
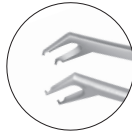

Hoskin

Tissue Forceps, curved
K5-1716 #16, fine grooved tips

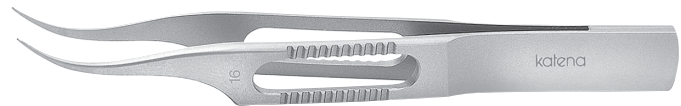
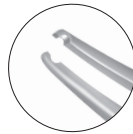

Hoskin

Tissue Forceps, straight
K5-1718 #18, fine grooved tips
K5-1719 #19, micro grooved tips
K5-1728 #28, very delicate, micro grooved tips

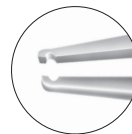

K5-1718

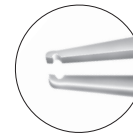

K5-1719

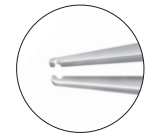

K5-1728

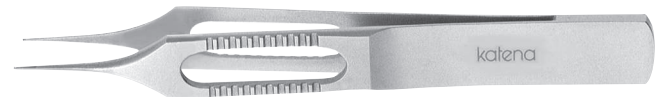

Forceps

Hoskin

Tissue Forceps, Colibri style

K5-1722 #22, micro grooved tips

K5-1730 #30, very delicate micro grooved tips

K5-1734 #34, pointed tips

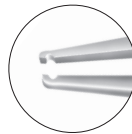

K5-1722

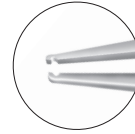

K5-1730

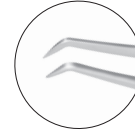

K5-1734



Pierse

Corneal Forceps

very delicate
1x1 teeth, 0.1mm
straight

K5-1800

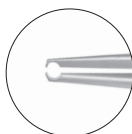

Fechtner

Conjunctiva Forceps

very delicate
ring shaped tips
with tying platform

K5-1820

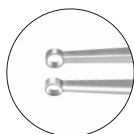

Castroviejo-Colibri

Forceps

very delicate
1x2 teeth, 0.12mm

K5-1900

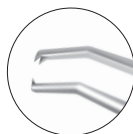

Forceps

Harms-Colibri

Forceps
very delicate
1x2 teeth, 0.12mm
with tying platform
K5-1902



Hyde

Corneal Forceps
2x2 teeth, 0.12mm
with tying platform
K5-1920

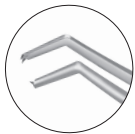

Bonn

Forceps
very delicate
1x2 teeth, 0.12mm
K5-2000



Bonn

Forceps
1x2 teeth, 0.12mm
with tying platform
K5-2020 stainless steel
KT5-2020 titanium



Forceps

Thorpe

Corneal Forceps
2x3 teeth, 0.12mm
with tying platform
K5-2100



McPherson

Tissue Forceps
1x2 teeth, 0.4mm
with tying platform
K5-2300 straight
K5-2310 angled

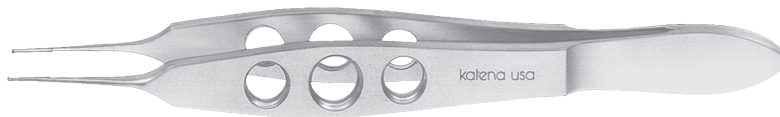

Kelman-McPherson

Forceps
8mm long jaws
1x2 teeth, 0.3mm
K5-2330

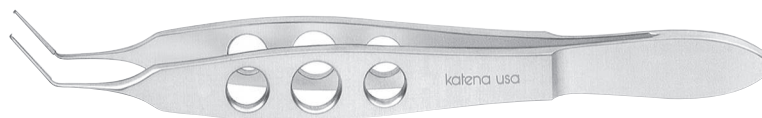

Hoffer-McPherson

Forceps
very delicate
11mm long jaws
1x2 teeth, 0.12mm
K5-2350



Forceps

Castroviejo

Suturing Forceps

1x2 teeth

with tying platform

K5-2500 0.12mm

K5-2510 0.3mm

K5-2520 0.5mm

K5-2530 0.9mm

KT5-2500 0.12mm, titanium



Snider-Castroviejo

Suturing Forceps

with guide pin

1x2 teeth, 0.12mm

with tying platform

K5-2550



Stern-Castroviejo

Fixation Forceps

1x2 teeth, 0.5mm

with lock

K5-2552



Moody

Fixation Forceps

1x2 teeth, 0.5mm

with lock

K5-2553 left (not shown)

K5-2554 right



Forceps

Helveston

Fixation Forceps
1x2 teeth, 0.6mm
*For globe fixation
during strabismus
procedures.*

K5-2556

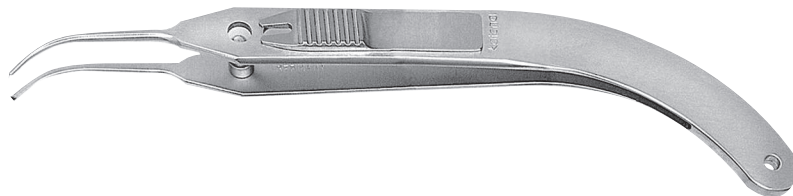

Girard

Corneoscleral Forceps
1x2 teeth, 0.12mm
with tying platform

K5-2900 for use in right hand

K5-2910 for use in left hand



Perl

Corneal Forceps
1x2, 0.08mm teeth
*For atraumatic grasping
and fixation of tissue.*

K5-2912 for use in right hand

K5-2914 for use in left hand

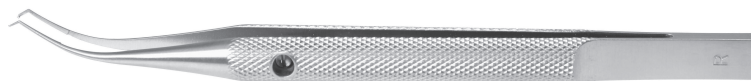
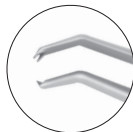

Maumenee-Colibri

Corneal Forceps
very delicate
1x2 teeth, 0.12mm

K5-3000

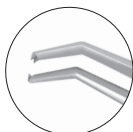

Forceps

Bishop-Harmon

Tissue Forceps

1x2 teeth

K5-3500 delicate

K5-3510 standard (not shown)

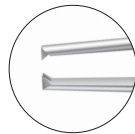

Bishop-Harmon

Dressing Forceps

criss-cross serrated tips

K5-3550

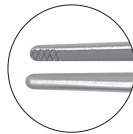

Fixation Forceps

1x2 teeth, 0.3mm

K5-3560 Sauer

K5-3562 Manhattan Eye & Ear,
with tying platform

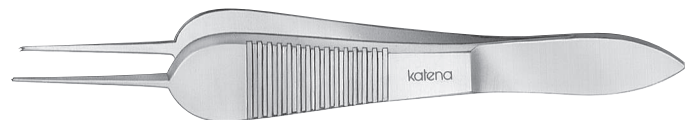

Dressing Forceps

serrated, delicate

K5-4000 straight

K5-4010 curved



Forceps

Tissue Forceps

1x2 teeth

K5-4100 delicate, straight

K5-4110 delicate, curved (not shown)

K5-4140 standard, straight (not shown)



Adson

straight, 5" (125mm) long

K5-4150 Dressing Forceps
serrated jaws,
delicate

K5-4152 Dressing Forceps
serrated jaws,
standard

K5-4170 Tissue Forceps
1x2 teeth, delicate

K5-4172 Tissue Forceps,
1x2 teeth, standard

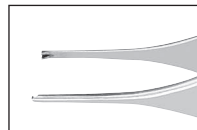
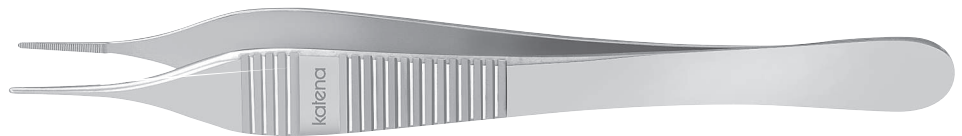

1x2 teeth, delicate

Bayonet

Dressing Forceps

serrated jaws

5 $\frac{3}{4}$ " (146mm) long

K5-4180



$\frac{3}{4}$

Lester

Fixation Forceps

straight

K5-4300 1x2 teeth

K5-4320 2x3 teeth (not shown)

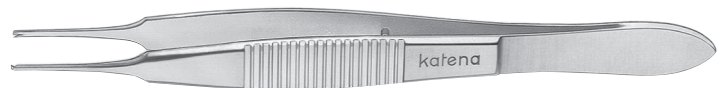

Forceps

Fixation Forceps

1x2 teeth

K5-4500 Bracken, delicate teeth

K5-4550 Elschnig, standard teeth
(not shown)



Troutman

Superior Rectus
Forceps

1x2 teeth

angled

K5-4700



Tying Forceps

For 8-0 to 11-0 sutures.

McPherson

5mm long smooth jaws

K5-5000 straight

KT5-5000 straight, titanium

K5-5010 angled

KT5-5010 angled, titanium

Kelman-McPherson

7.5mm long smooth jaws

K5-5030 angled

KT5-5030 angled, titanium

Bechert

10mm long smooth jaws

K5-5049 angled

Gaskin

11mm long smooth jaws

K5-5050 angled

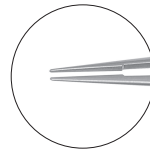

K5-5000

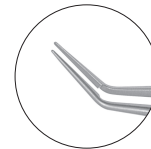

K5-5010

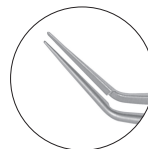

K5-5030

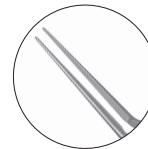

K5-5049

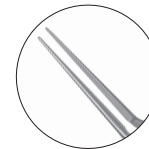

K5-5050

Forceps

Haberle-McPherson

Lens Holding Forceps
7.5mm long jaws
with groove, angled
For grasping IOL haptic.



K5-5040

Kurstin

Flap Stretching Forceps
disc shaped
serrated jaws
Designed for stretching
the flap to eliminate striae.

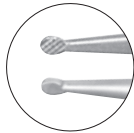

K5-5056

Buratto

LASIK Flap Forceps
disc shaped
serrated jaws

K5-5058



Mendez

Multi-Purpose
LASIK Forceps
spatulated jaws and tips
smooth grasping surfaces
vaulted shanks

For lifting, dissecting and
grasping the corneal flap.

K5-5060



TIP CROSS SECTION



Forceps

Inamura

Capsulorrhexis Forceps
delicate tapered shanks
to seal the incision during
continuous curvilinear
capsulorrhexis
Excellent for MICS.

K5-5070



Utrata

Capsulorrhexis Forceps
very delicate, short handle
triangular grasping tips
extremely thin with landmarks
at 2.5mm and 5.0mm

K5-5071 straight



Masket

Capsulorrhexis Forceps
very delicate, short handle
triangular grasping tips
extremely thin with landmarks
at 2.5mm and 5.0mm

K5-5074 vaulted



Kraff

Capsule Tag Forceps
11mm long shanks
1.5mm long grasping tips

K5-5080



Forceps

Utrata

Capsulorrhexis Forceps
very delicate
triangular grasping tips
extremely thin
11mm long shanks

K5-5081 stainless steel

KT5-5081 titanium



Also available for MICS, see K5-5091.

Utrata

Capsulorrhexis Forceps
very delicate
triangular grasping tips
extremely thin
11mm long shanks
round handle with guide pin
for alignment

K5-5082



Neyyas

Capsulorrhexis Forceps
cystotome shaped tips
extremely thin
11mm long shanks
*For tearing and grasping
the anterior capsule.*

K5-5083

Also available for MICS, see K5-5093.

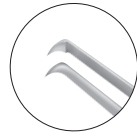

Masket

Capsulorrhexis Forceps
very delicate
triangular grasping tips
extremely thin 11mm long
vaulted shanks

K5-5084



Forceps

Masket

Capsulorrhexis Forceps
 very delicate
 triangular grasping tips
 extremely thin 11mm long
 vaulted shanks
 round handle with guide pin
 for alignment



K5-5086

Jaffe

Capsulorrhexis Forceps
 very delicate
 round grasping tips
 extremely thin
 11mm long shanks



K5-5088

Giannetti

MICS Capsulorrhexis Forceps
 ultra delicate shanks and tips
 maximum jaw opening 1.75mm
*For performing capsulorrhexis
 through a micro incision.*

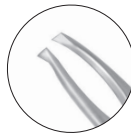

K5-5090

Utrata

MICS Capsulorrhexis Forceps
 very delicate
 triangular grasping tips
 thin 11mm shanks
 maximum jaw opening 1.75mm
*For performing capsulorrhexis
 through a micro incision.*



K5-5091

Forceps

Giannetti

MICS Capsulorrhexis Forceps
ultra-delicate shanks and tips
maximum jaw opening of 1.75mm
flat handle

*For performing capsulorrhexis
through a micro incision.*

K5-5092



Neyvas

MICS Capsulorrhexis Forceps
cystotome shaped tips
ultra-delicate shanks and tips
maximum jaw opening of 1.75mm
flat handle

*For penetrating and grasping the anterior
capsule while performing a capsulorrhexis
through a micro incision.*

K5-5093



Florakis

Endothelial Forceps
extra-delicate, reversed
triangular tips angled 75°
*To aid in the removal of endothelium
from the host cornea.*

K5-5095



Sinskey

Tying Forceps
very delicate
smooth jaws
For 8-0 to 11-0 sutures.

K5-5100 straight

K5-5110 curved (not shown)



Forceps

Anis

Tying Forceps
extra delicate
smooth jaws
For 9-0 to 11-0 sutures.

K5-5112 straight (not shown)

K5-5113 curved

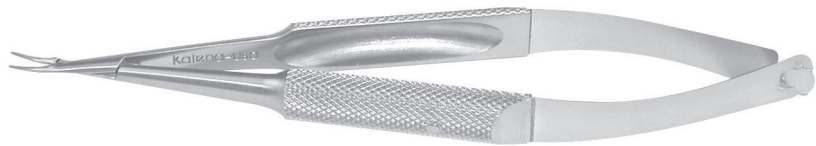

Freeman-Jaffe

Lens Holding Forceps
with longitudinal groove
For grasping IOL haptic.

K5-5190

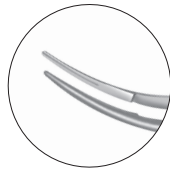

Jaffe

Tying Forceps
very delicate
smooth jaws
6mm long platform
For 8-0 to 11-0 sutures.

K5-5200 straight

K5-5210 curved



Gerl

Tying Forceps
curved shanks
6mm long platform
For 8-0 to 11-0 sutures.
titanium

KT5-5215

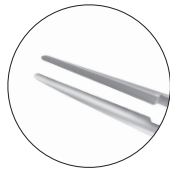

Forceps

Tennant

Tying Forceps
extra delicate smooth jaws
with 6mm long platform
round handle with guide pin
For 9-0 to 11-0 sutures.

K5-5220 straight

KT5-5220 straight, titanium

K5-5230 curved

KT5-5230 curved, titanium

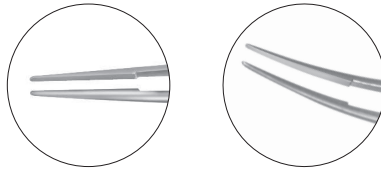

Maumenee

Tying Forceps
concave-convex jaws
round handle with guide pin
For 8-0 to 11-0 sutures.

K5-5234 straight

K5-5235 angled



JAWS CROSS SECTION



Harms

Tying Forceps
standard, smooth jaws
for 7-0 to 9-0 sutures.

K5-5400 straight

K5-5410 curved

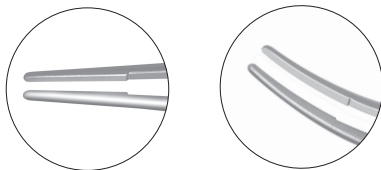

Helveston

Tying Forceps
standard, smooth jaws
For 4-0 to 6-0 sutures.

K5-5420

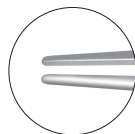

Forceps

Fine

Tying Forceps
standard, smooth jaws
For 7-0 to 9-0 sutures.

K5-5550



Arita

Meibomian Gland Compressor
broad, smoothly polished jaws

K5-5900



Barraquer

Cilia Forceps
lightly angled
Textured jaws provide superior grasping capabilities.

K5-6000

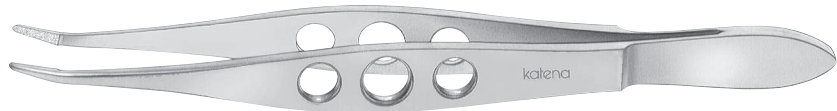

Katena

Cilia Forceps
slanted jaws
gold plated

K5-6020



Gradle

Cilia Forceps
smooth jaws

K5-6100



Forceps

Bonaccolto

Conjunctiva Forceps
longitudinally serrated jaws
with cross serrations at tips

K5-6200 1.2mm wide

K5-6210 1.7mm wide (not shown)

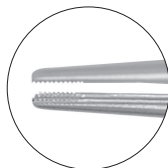

Nugent

Utility Forceps

K5-6214 smooth jaws (not shown)

K5-6215 serrated jaws



Gold

Punctal Plug Forceps
0.2mm wide longitudinal
groove inside jaws
pointed tips

K5-6218



Foreign

Body Forceps
straight

K5-6400



Forceps

Utility & Splinter

Forceps
pointed, short jaws
Suitable for epilation.
K5-6500 #H



Jewelers

Forceps
standard, straight
K5-6510 #1



Jewelers

Forceps
delicate, straight
K5-6520 #3-C



Jewelers

Forceps
delicate, straight
K5-6530 #3



Jewelers

Forceps
delicate, straight
K5-6540 #4



Forceps

Jewelers

Forceps
extra delicate, straight
K5-6550 #5



Jewelers

Forceps
extra delicate, angled
K5-6560 #5/45



Jewelers

Forceps
curved
K5-6570 #7



Suture

Removal Forceps
very fine pointed tips
with textured jaws
Ideal for grasping wet sutures.
K5-6575



Forceps

Jaffe

Utility Forceps
very delicate smooth jaws
curved

K5-6600



Arruga

Capsule Forceps

K5-7000



Akahoshi

Phaco PreChopper

4.5mm long delicate jaws
with sharp tips

*For cracking, dividing and rotating
the nucleus without sculpting.*

K5-7230



Akahoshi

Combo PreChopper

*For cracking, dividing and rotating
both hard and soft nuclei without
sculpting.*

K5-7232



Forceps

Ernest

Nucleus Cracker
extra delicate cross-action
serrated paddle tips

K5-7240 For cracking the nucleus
through a 2.5mm incision.

K5-7242 For cracking the nucleus
through a 2mm incision.



Dodick

Nucleus Cracker
cross-action
longitudinally serrated
paddle shaped jaws
*For cracking the nucleus
through a 3mm incision.*

K5-7244

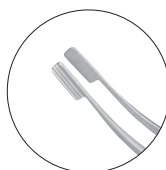

Hu

Femto Forceps
blunted 0.3mm tips
cross-action mechanism
*For opening incisions
created with a
femtosecond laser.*

K5-7245



Alfonso

Nucleus Grasping Forceps
two short rows of
delicate interlocking teeth
*For grasping and extracting
nucleus fragments.*

K5-7253



Forceps

Femto

Nucleus Forceps
22 gauge
flattened textured tips
angled at 90°
reverse action

*For removing a complete cap,
finishing a rhexis and
splitting nucleus fragments.*

K5-7270

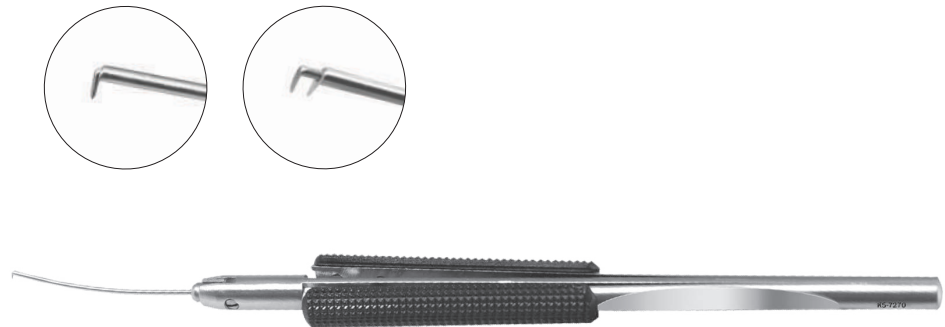

Vitreo-Retinal Forceps

stainless steel with
serrated plastic handle
autoclavable

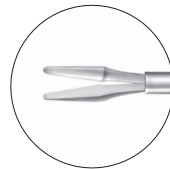
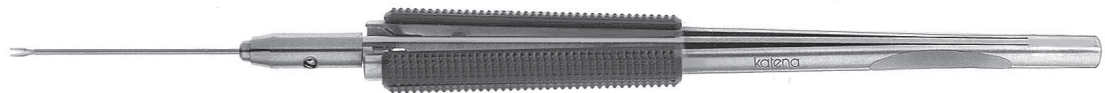

smooth jaws
20 gauge, straight
K5-7500

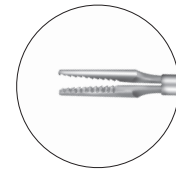

serrated jaws
20 gauge, straight
K5-7510

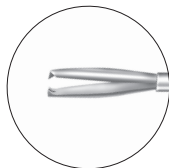

smooth jaws, 1x2 teeth
20 gauge, straight
K5-7520

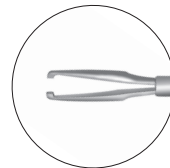

smooth jaws
end gripping
20 gauge, straight
K5-7530

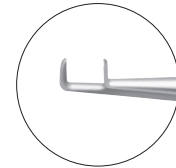

smooth jaws
20 gauge, vertical
K5-7540

Forceps

Endothelial Grasping Forceps

curved, 23 gauge
delicate end-gripping platforms
jaws 90° off-set from
“squeeze handle”
mechanism

K5-7550

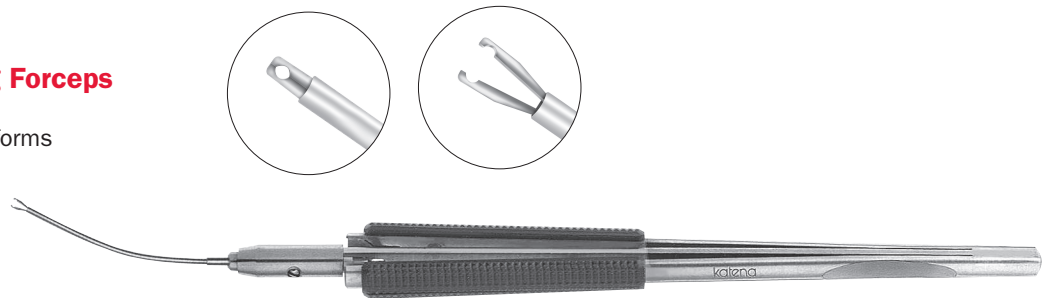

ICL™

Lens Cartridge Loading Forceps
straight, 20 gauge
jaws feature a series
of concave and
convex surfaces

K5-7560

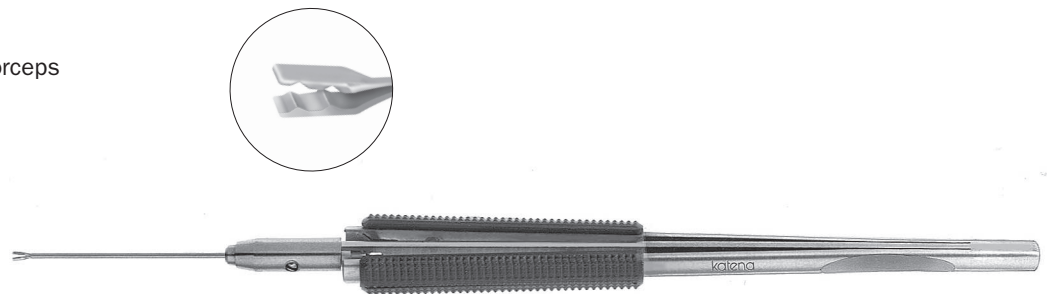

Donnenfeld

Micro IOL Holding Forceps
21 gauge
blunt, paddle-shaped tips
central hole for traction and visibility
*For grasping a soft IOL during cutting
and explantation.*

K5-7570

(use with K4-5560)

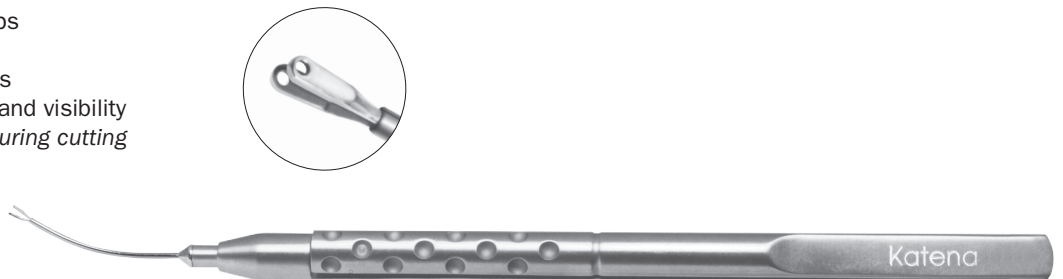

Forceps

MICS Capsulorrhexis Forceps

23 gauge curved shaft with short micro-grasping tips
 Designed for use through a very small paracentesis.

K5-7651 Alio

K5-7655 Fine-Ikeda

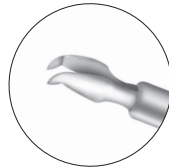

K5-7651

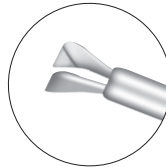

K5-7655



Katena

“Squeeze Handle” Forceps
 These “squeeze handle” instruments feature titanium handles to reduce overall weight, and front ends of hardened stainless steel for secure grasping.



horizontal opening serrated jaws
K5-7600 20ga.
K5-7703 23ga.

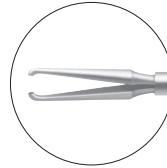

horizontal opening end gripping jaws
K5-7610 20ga.
K5-7713 23ga.
K5-7715 25ga.

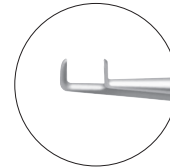

vertical opening smooth side gripping jaws
K5-7620 20ga.

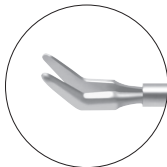

membrane peeling smooth 45° angled jaws
K5-7630 20ga.

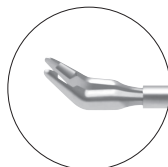

membrane peeling grooved 45° angled jaws
K5-7631 20ga.

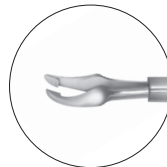

asymmetrical
K5-7723 23ga.
K5-7725 25ga.

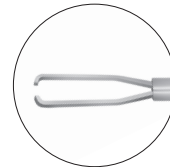

ILM
K5-7733 23ga.
K5-7735 25ga.

Forceps

Prasad

Micro Tying Forceps
23 gauge
straight 2.65mm long jaws
with textured platforms
25mm long curved shaft

K5-7743 straight

K5-7753 angled

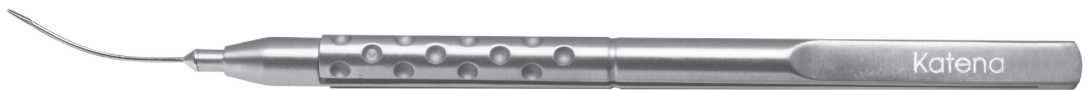
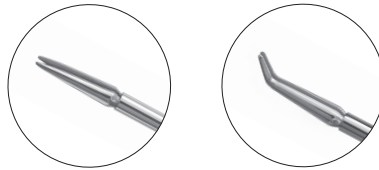

Watzke

Sleeve Spreading Forceps

K5-7950

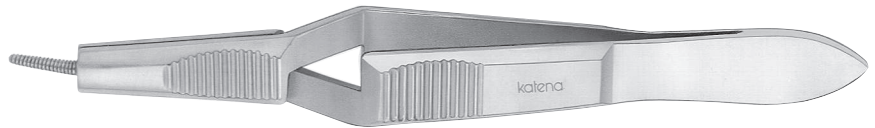

Feaster

Lens Holding Forceps
gently curved shank
0.25mm diameter round tip
with guard

K5-8001

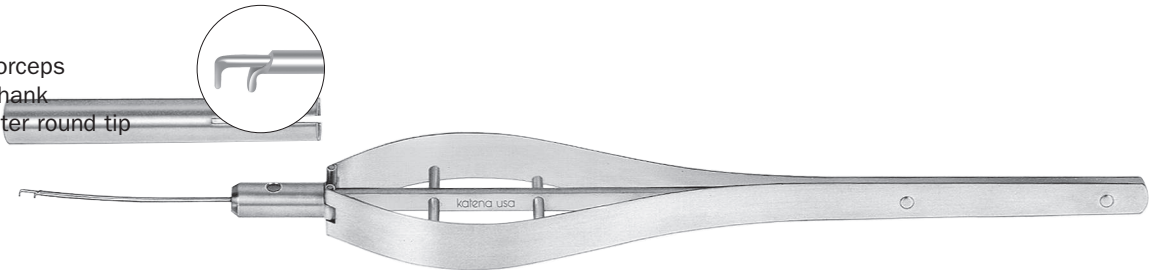

Rosenwasser

Donor Lamella Inserting Forceps
thin vaulted 12mm long shanks
precalibrated heel stop to
prevent tips from closing

K5-8010

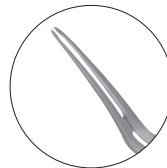

Forceps

ICL™

Loading Forceps
11mm long
smoothly polished jaws

K5-8180



ICL™

Loading Forceps
11mm long
finely textured jaws

K5-8181



Dodick

IOL Folding Forceps
For soft IOLs.

K5-8210



Forceps

Livornois

IOL Folding Forceps
concave jaw surfaces
For soft IOLs.

K5-8215

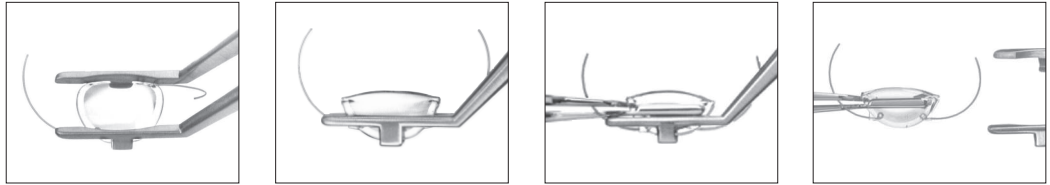

Steinert

IOL Inserting Forceps
conically shaped jaws
with flat inside surfaces
Used for folding and
inserting soft IOLs.

K5-8219



Livornois

IOL Holding Forceps
highly polished round jaws
For holding a soft IOL
while folding with an
inserting forceps.

K5-8220 straight (not shown)

K5-8221 angled

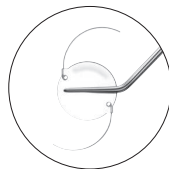

Forceps

Livernois-McDonald

IOL Inserting Forceps
5mm long concave jaws
patented cross-action
For inserting silicone IOLs.
K5-8225

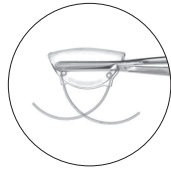

Ernest-McDonald

IOL Inserting Forceps
5mm long straight jaws
low profile
patented cross-action
For inserting silicone IOLs.
K5-8228



Ernest-McDonald II

IOL Inserting Forceps
5mm long straight jaws
extra low profile
patented cross-action
For inserting silicone IOLs.
K5-8229



Faulkner

Lens Holding Forceps
round, smooth jaws
For holding soft IOLs.
K5-8230



Forceps

Buratto

Soft IOL Inserting Forceps
extra delicate highly
polished convex jaws
*For foldable acrylic and
silicone IOLs.*

K5-8268



Spaleck

Soft IOL Inserting Forceps
delicate highly polished
convex jaws
*For foldable acrylic and
silicone IOLs.*

K5-8270

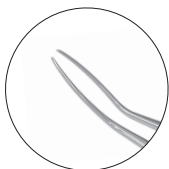

Ernest-McDonald

IOL Inserting Forceps
polished bi-convex jaws
patented cross-action
For acrylic IOLs.

K5-8272



JAWS CROSS SECTION



Bechert

Lens Holding Forceps
very delicate flat jaws
gently curved

K5-8476



Forceps

Kratz

Lens Holding Forceps
very delicate narrow jaws
curved

K5-8480



Blaydes

Lens Holding Forceps
very delicate narrow jaws
angled 45°

K5-8500



KAMRA™

Inlay Forceps
very thin, highly polished
paddle-shaped jaws
*For use in picking up and placing
the Kamra™ implant.*

K5-8510



Shepard

Lens Holding Forceps
duckbill shaped jaws
gently curved

K5-8600



Forceps

Clayman

Lens Holding Forceps
delicate angled jaws
gently curved

K5-8700



Jameson

Muscle Forceps
with slide lock

K5-9000 4 teeth, child size, right

K5-9010 4 teeth, child size, left (not shown)

K5-9020 6 teeth, adult size, right (not shown)

K5-9030 6 teeth, adult size, left



Berke

Ptosis Forceps
with slide lock
longitudinally grooved jaws

K5-9300 20mm long

K5-9310 27mm long



Forceps

Ptosis

Lid Clamp
6-pin, concave
longitudinal grooves
in tips, sliding lock

K5-9315



Erhardt

Lid Forceps

K5-9400



Downes

Lid Clamp

*Designed for protecting the
eye and holding the lid margin
during upper lid laser
blepharoplasty.*

K5-9410

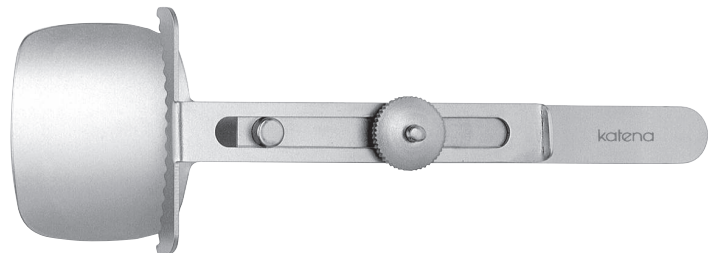

Forceps

Chalazion Forceps

round

K5-9450 Lambert, 8mm I.D.

K5-9500 Hunt, 12mm I.D.

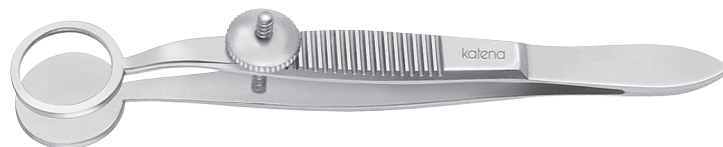

Chalazion Forceps

oval

K5-9550 Baird, 11 x 8mm I.D.
small

K5-9600 Francis, 14 x 11mm I.D.
medium

K5-9650 Desmarres, 20 x 13mm I.D.
large

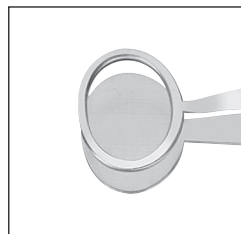
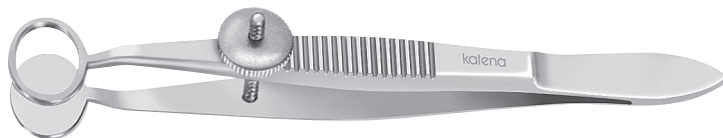

K5-9600



K5-9650

Wies

Chalazion Forceps
grooved upper jaw

K5-9750



Forceps

Serrefine

serrated jaws
small
1½" (38mm) long
K5-9850



Hartmann

Mosquito Forceps
extra delicate
3¾" (95mm) long
K5-9900 straight
K5-9910 curved



Halsted

Mosquito Forceps
delicate
5¾" (145mm) long
K5-9940 straight
K5-9950 curved



Forceps

Baby Jones

Towel Clamp
cross-action
2¼" (55mm) long
K5-9960



Backhaus

Towel Clamp
K5-9964 3½" (90mm) long
K5-9965 5¼" (135mm) long



Needle Holders

McPherson

Needle Holder
very delicate jaws

- K6-1000** straight jaws, with lock
- K6-1010** straight jaws, without lock
- K6-1020** curved jaws, with lock
- K6-1030** curved jaws, without lock



Jaffe

Needle Holder
delicate conical jaws

- K6-1100** straight, with lock
- K6-1120** curved, with lock
- K6-1130** curved, without lock

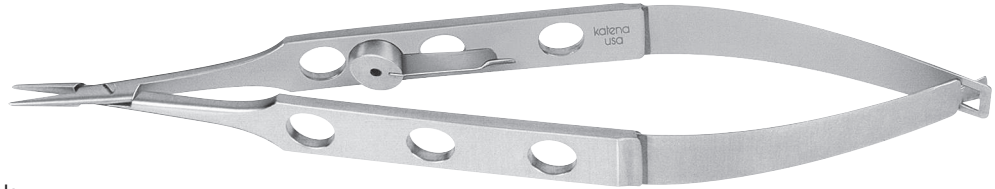

Castroviejo

Needle Holder
delicate jaws

- K6-1500** straight, with lock
- K6-1510** straight, without lock
- K6-1520** curved, with lock
- K6-1530** curved, without lock



Needle Holders

Castroviejo

Needle Holder
standard jaws
straight, with lock
K6-1560

**Castroviejo**

Needle Holder
standard jaws
curved, with lock
K6-1580

**Kalt**

Needle Holder
delicate smooth jaws
straight, with lock
K6-1800



Needle Holders

Drews

Needle Holder
extra delicate jaws

- K6-2990** straight, with lock
- K6-2991** straight, without lock
- K6-2992** curved, with lock
- K6-2993** curved, without lock

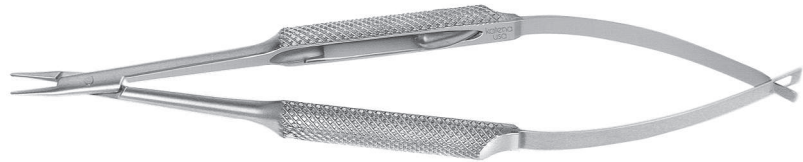

Barraquer

Needle Holder
short model
very delicate jaws
straight

- K6-3000** with lock
- K6-3010** without lock

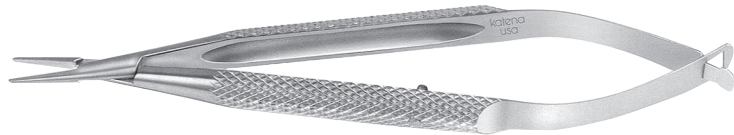

Barraquer

Needle Holder
short model
very delicate jaws
curved

- K6-3020** with lock
- K6-3030** without lock



Troutman

Needle Holder
delicate jaws
strongly curved

- K6-3250** without lock
- K6-3260** with lock

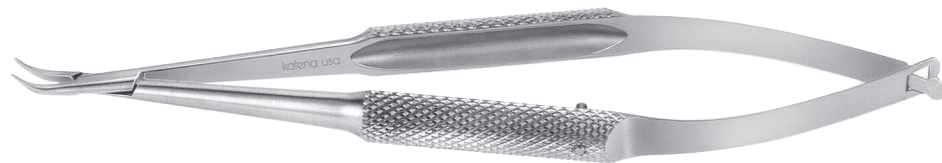

Needle Holders

Barraquer

Needle Holder
very delicate jaws
curved

K6-3300 with lock

K6-3310 without lock

KT6-3300 titanium, with lock

KT6-3310 titanium, without lock

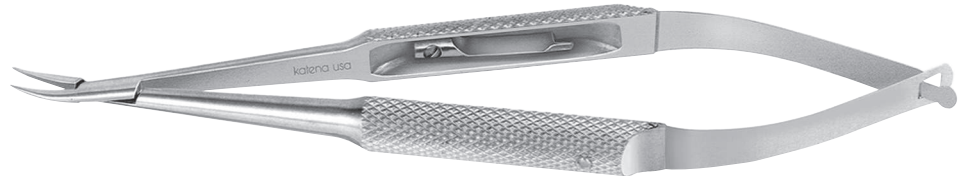

Barraquer

Needle Holder
delicate jaws
straight

K6-3500 with lock

K6-3510 without lock



Barraquer

Needle Holder
delicate jaws
curved

K6-3520 with lock

K6-3530 without lock



Needle Holders

Barraquer

Needle Holder
standard jaws
curved

K6-3620 with lock

K6-3630 without lock



Anis

Needle Holder
extra delicate jaws
straight

K6-3750 with lock

K6-3751 without lock

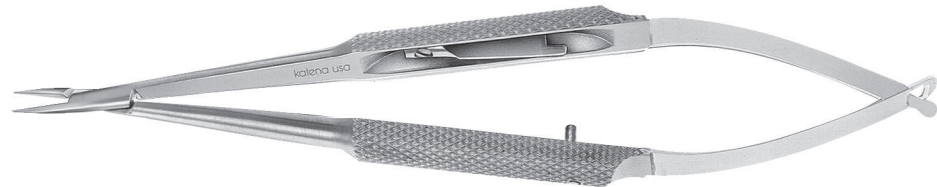

Anis

Needle Holder
extra delicate jaws
curved

K6-3752 with lock

K6-3753 without lock



Needle Holders

Katena

Needle Holder
extra delicate jaws
straight

K6-3800 with lock

K6-3810 without lock

KT6-3800 titanium, with lock

KT6-3810 titanium, without lock

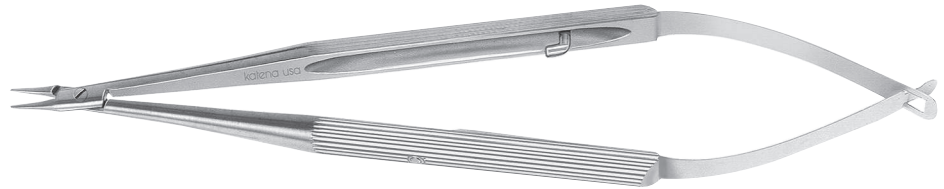

Katena

Needle Holder
extra delicate jaws
curved

K6-3820 with lock

K6-3830 without lock

KT6-3820 titanium, with lock

KT6-3830 titanium, without lock

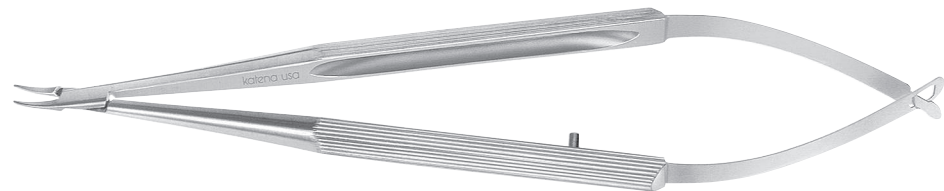

McIntyre

Fish Hook Needle Holder
straight, with lock

K6-3900

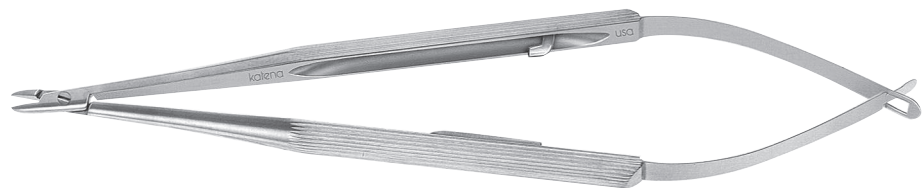

Rongeurs

Kerrison

Bone Nibbling Rongeur
9mm opening

K7-1800 size 0, 3.0mm wide

K7-1801 size 1, 3.5mm wide

K7-1802 size 2, 4.0mm wide

K7-1803 size 3, 4.5mm wide

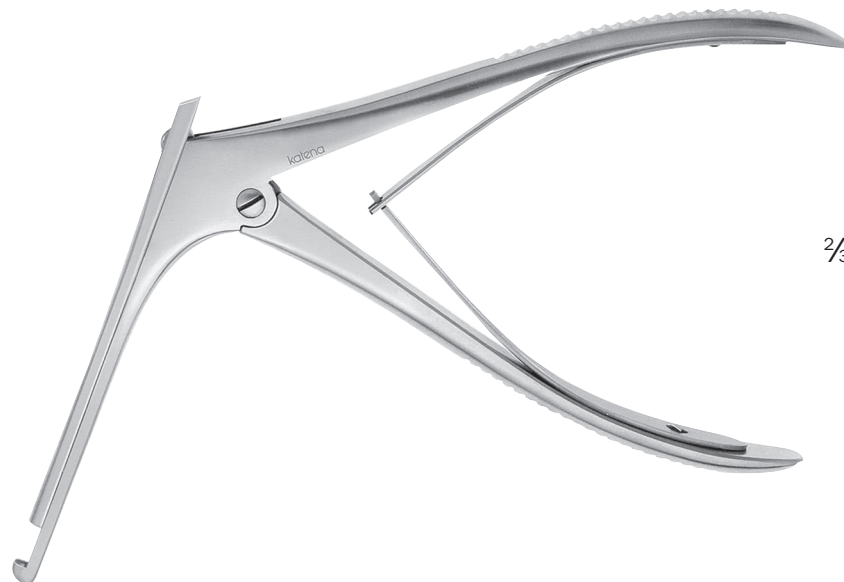
 $\frac{2}{3}$

Citelli

Bone Nibbling Rongeur
7mm opening
2.0mm wide

K7-1805

 $\frac{2}{3}$

Lacrimal Instruments

Beyer
 Rongeur
 single action
K7-1810



2/3

Nasal
 Speculum
K7-1820 infant
K7-1821 child
K7-1822 adult



2/3

Freer
 Periosteal Elevator
 one end blunt
 other end semi-sharp
 4.5mm wide blades
K7-1830



2/3

Lacrimal Instruments

Joseph

Periosteal Elevator
gently curved tip
K7-1835

 $\frac{3}{4}$

West

Lacrimal Chisel
straight
K7-1840

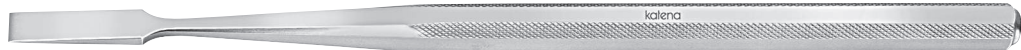
 $\frac{3}{4}$

Freer

Lacrimal Chisel
curved
K7-1845

 $\frac{3}{4}$

Lacrimal Instruments

Mallet

lead filled
stainless steel head
K7-1860

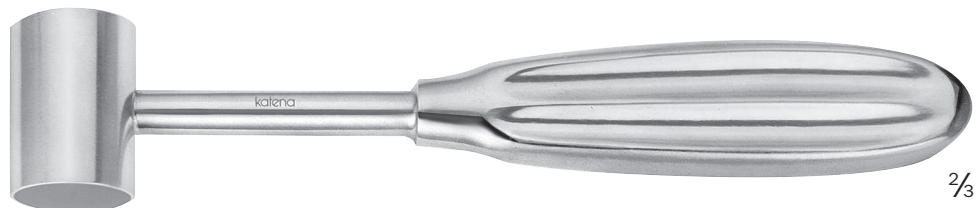

Harms

Trabeculotomy Probe
K7-1000 right
K7-1010 left

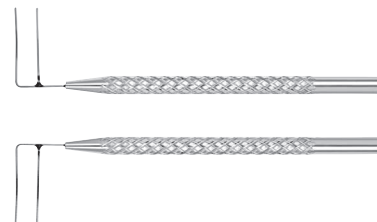

Infant

Lacrimal Dilator
very fine blunt tip
K7-2000



Muldoon

Lacrimal Dilator
K7-2100



Lacrimal Instruments

Wilder

Lacrimal Dilator

K7-2110 size 1, fine taper

K7-2120 size 2, medium taper

K7-2130 size 3, heavy taper

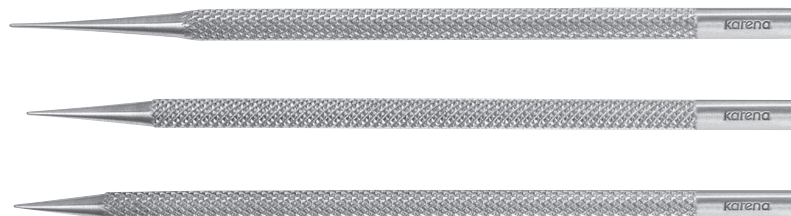

Castroviejo

Lacrimal Dilator

double-end

fine and

medium taper

K7-2300



Miyake

Lacrimal Probe

round knurled handle

140mm long, patented

K7-2480 set of 5

K7-2481 .45 and .5mm dia.

K7-2483 .55 and .6mm dia.

K7-2485 .65 and .7mm dia.
marked in 10mm
increments

K7-2487 .75 and .8mm dia.
single mark at
10mm from tips

K7-2489 .85 and .9mm dia.
single mark at
10mm from tips

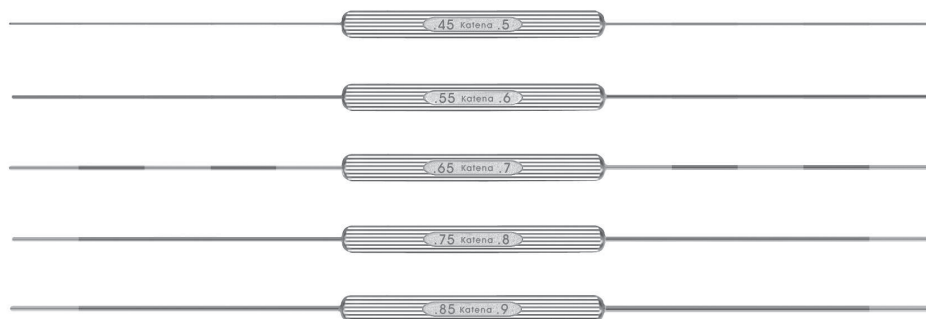

U.S. Patent # 6,093,198

REDUCED SIZE

Lacrimal Instruments

Bowman

Lacrimal Probe
malleable stainless steel

- K7-2500** set of 6
- K7-2510** size 0000 & 000
- K7-2520** size 00 & 0
- K7-2530** size 1 & 2
- K7-2540** size 3 & 4
- K7-2550** size 5 & 6
- K7-2560** size 7 & 8

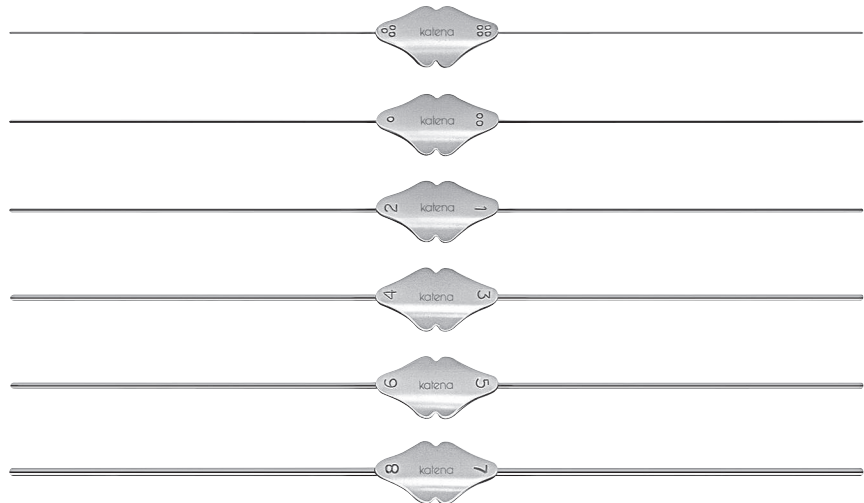

3/4

Catalano

Lacrimal Intubation Set
includes 2 blunt
0.7mm diameter probes
attached to 30.5cm long
silicone tubing
.012" I.D., .025" O.D.

- K7-2600** set
- K7-2602** silicone tubing only



3/4

Jackson

Lacrimal Intubation Set
includes 2 blunt
0.9mm diameter probes
attached to 30.5cm long
silicone tubing
.012" I.D., .025" O.D.

- K7-2610** set
- K7-2602** silicone tubing only



3/4

Lacrimal Instruments

Crawford

Lacrimal Intubation Set
includes 2 olive tip
0.6mm diameter probes
attached to 30.5cm long
silicone tubing
.012" I.D., .025" O.D.

K7-2620 set

K7-2602 silicone tubing only



$\frac{3}{4}$

Crawford

Retrieving Hook
for Crawford lacrimal
intubation probes

K7-2623



$\frac{3}{4}$

Bodian

Lacrimal Probe Set
includes 2 curved
blunt 1mm diameter probes
attached to 30.5cm long
silicone tubing
.012" I.D., .025" O.D.

K7-2630 set

K7-2602 silicone tubing only



Pigtail

Probe
with suture holes

K7-2900



$\frac{3}{4}$

Cannulas

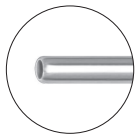
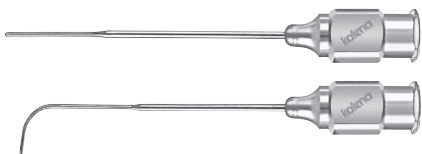

Lacrimal

Cannula
malleable tip
23 gauge

K7-3000 straight
K7-3010 curved

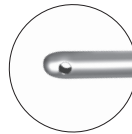

McIntyre

Lacrimal Cannula
dual 0.3mm side ports
23 gauge

K7-3020 straight
K7-3030 curved

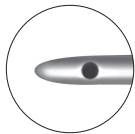

Shahinian

Lacrimal Cannula
bullet shaped tip
0.3mm side port
23 gauge, 11mm long

K7-3014

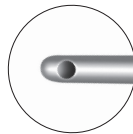

West

Lacrimal Cannula
blunt tip
0.3mm side port
23 gauge

K7-3100

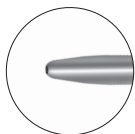

Burnstine

Lacrimal Cannula
tapered tip
0.15mm end opening
23 gauge, 13mm long

K7-3016

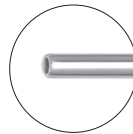

Silicone Oil

Injection Cannula
7mm long
23 gauge

K7-3210

Cannulas



Air Injection

Cannula
angled at 5mm

K7-3500 30 gauge

K7-3520 27 gauge

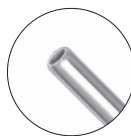

Viscoelastic

Aspirating Cannula
angled at 10mm

K7-3550 22 gauge

K7-3552 19 gauge



Arbisser

A/C Cannula
angled at 5.5mm
27 gauge

K7-3510



Rainin

Air Injection Cannula
flat tip
angled at 7mm

K7-3570 30 gauge

K7-3580 27 gauge



Air Injection

Cannula
angled at 7mm

K7-3502 30 gauge

K7-3522 27 gauge



Capsule

Staining Cannula
0.2mm posterior port
angled at 8mm
25 gauge

K7-3585

Cannulas



Bottom View



DALK

Air Injection Cannula
flattened, vaulted
0.2mm posterior port near tip
27 gauge
K7-3590

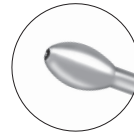

Troutman

Olive Tip Cannula
delicate
25 gauge
K7-3800



Top View



Bottom View



Rosenwasser

DALK Cannula
flattened "cobra-shaped" tip
0.2mm posterior port
27 gauge
K7-3595



LASEK

Alcohol Cannula
delicate olive shaped tip
angled at 10mm
25 gauge
K7-3805



Randolph

Cyclodialysis Cannula
formed flat tip
angled at 13mm
K7-3600 21 gauge
K7-3620 19 gauge



Welsh

Flat Olive Tip Cannula
25 gauge
K7-3820 angled forward
K7-3830 angled left
K7-3840 angled right

Cannulas

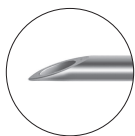

Atkinson

Retrobulbar Needle
23 gauge, 35mm long
K7-4000

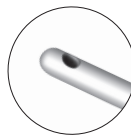

Corbin

Sub-Tenon's Anesthesia Cannula
smooth rounded tip
0.3mm side port
23 gauge
K7-4008



Fukasaku

Anesthesia Cannula
gently curved, smooth tip
24 gauge
*For pinpoint placement of
local anesthesia solution into
sub-Tenon's space.*
K7-4002



Gross

Sub-Tenon's Anesthesia Cannula
gently curved
flat burnished tip
front opening, 21 gauge
K7-4010



Stevens

Sub-Tenon's Anesthesia Cannula
gently curved, flat tip
19 gauge
*For atraumatic entry into
sub-Tenon's space to inject
local anesthetic.*
K7-4005

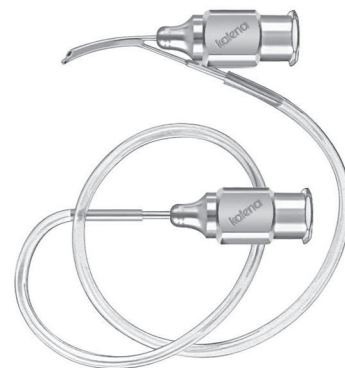
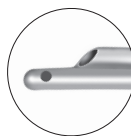

Simcoe

Irrigating-Aspirating
Cannula
original model, 15mm long
0.3mm diameter aspiration port
front opening irrigation port, 23 gauge thin wall
*For aspiration through tubing
hub and irrigation through
luer-lock hub.*
K7-4300

Cannulas

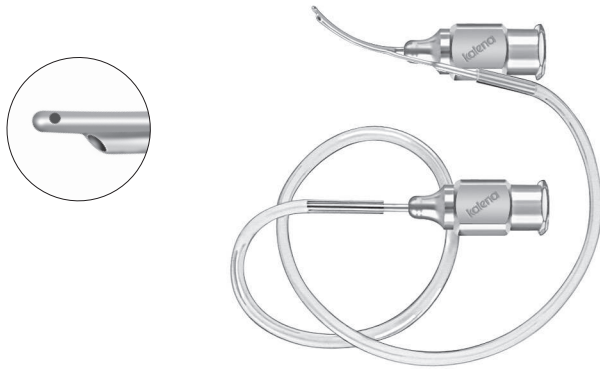

Reversed Simcoe

Irrigating-Aspirating Cannula
15mm long

0.3mm diameter aspiration port
front opening irrigation port
23 gauge thin wall

*For aspiration through luer-lock hub
and irrigation through tubing hub.*

K7-4302



Simcoe

Irrigating-Aspirating Cannula
U-shaped, with 0.3mm anterior
aspiration port, 23 gauge
Supplied with silicone tubing
and adaptor.

*For aspiration through tubing
hub and irrigation through
luer-lock hub.*

K7-4308 curved right

K7-4309 curved left

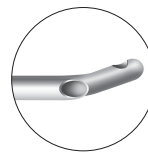

right side

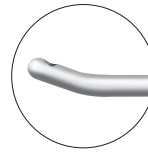

left side



Gess

Irrigating-Aspirating Cannula
U-shaped, with end opening
aspiration port, 23 gauge
Supplied with silicone tubing and adaptor.

*For aspiration through tubing
hub and irrigation through
luer-lock hub.*

K7-4304 curved right

K7-4305 curved left

Strauss-Simcoe

MSICS I/A Cannula
23 gauge, 0.3mm port
elongated and gently curved
with 15° angled tip.

*For aspiration through tubing
hub and irrigation through
luer-lock hub.*

K7-4320

Cannulas

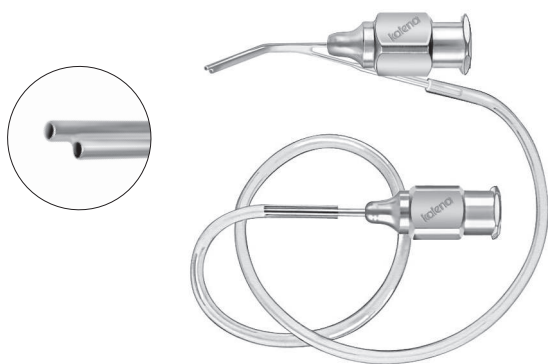

Gills

Irrigating-Aspirating Cannula
front openings with irrigating
port recessed 0.5mm from tip
angled, 23 gauge thin wall
Supplied with silicone tubing
and adaptor.

K7-4450

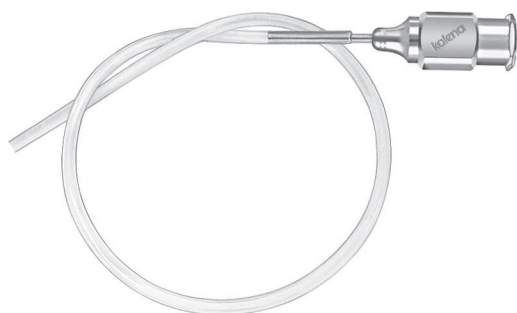

Silicone Tubing

for I/A cannulas

K7-4455 tubing and adaptor

K7-4456 tubing only
12" (30.5cm)



Kelman

Cystotome
sharp point and
sharp cutting edge
22 gauge

K7-4600



Kratz

Cystotome
sharp point and
sharp cutting edge
formed, 22 gauge

K7-4601

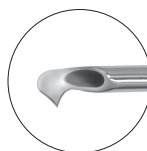

Double-Edge

Cystotome
sharp point and
sharp cutting edges
22 gauge

K7-4640

Cannulas



Knolle-Kelman

Cystotome
small blade
sharp point and
sharp cutting edge
22 gauge

K7-4660

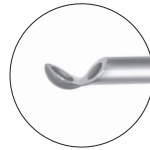

Shammas

Posterior Capsule
Polishing Curette
1mm diameter cup with
textured base
22 gauge

K7-4850



McIntyre

Cystotome
angled at 10mm
sharp point
23 gauge

K7-4680



Kraff

Posterior Capsule
Polishing Curette
1.75mm diameter cup
with semi-sharp edge
irrigating port in center of cup
25 gauge

K7-4880

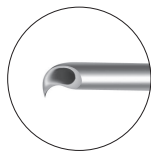

Lieppman

Cystotome
extra small sharp point
and sharp cutting edge
22 gauge

K7-4700



Henderson

MICS Capsule Polishing Cannula
finely textured, 1.25mm wide
disc-shaped tip, with 0.5mm
posterior facing port
23 gauge

K7-4890

Cannulas



Dvali

Capsule Polisher
dual side ports
textured posterior surface
and smooth anterior surface
23 gauge
K7-4892



Shapiro

Posterior Capsule Polisher
carbide impregnated tip
dual 0.3mm side ports
curved, 23 gauge
K7-4906



Kratz

Scratcher
front opening with
carbide impregnated tip
lightly angled
22 gauge
*For polishing the posterior
capsule.*
K7-4900



Jensen

Capsule Polisher
carbide impregnated
front opening
*For polishing the anterior
and/or posterior capsule.*
K7-4920 25 gauge, half-textured tip
K7-4921 25 gauge, fully-textured tip
K7-4930 23 gauge, half-textured tip
K7-4931 23 gauge, fully-textured tip



Rubman-Katzin

Posterior Capsule Polisher
carbide impregnated tip
with smooth closed end
irrigating side port
facing into curve
22 gauge
K7-4902



Lu

Posterior Capsule Polisher
flattened olive shaped tip
carbide impregnated on
the posterior surface
front opening, 23 gauge
K7-4933

Cannulas



Knolle

Posterior Capsule Polisher
finely textured
2mm angled tip
front opening

K7-4940 30 gauge

K7-4950 23 gauge

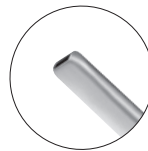

Peters

Hydrodissection Cannula
3mm long, vertically flattened tip
25 gauge

K7-5053

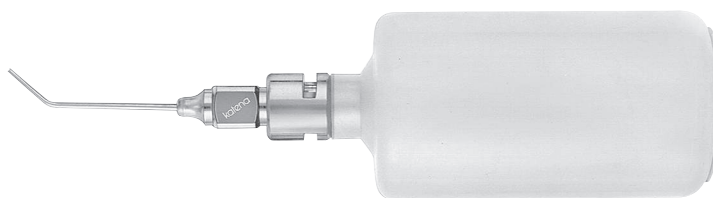

Bishop-Harmon

Anterior Chamber Irrigator
includes 19 gauge angled
cannula, adaptor and blue
silicone bulb

K7-5000 complete

K7-5005 silicone bulb
and adaptor

K7-5010 silicone bulb

K7-5020 adaptor

K7-5050 19 gauge cannula

K7-5052 21 gauge cannula



Hydrodissection

Cannula
angled at 8mm
flat tip, front opening
25 gauge

K7-5054

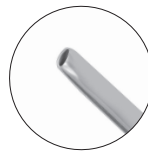

Seeley

Hydrodissection Cannula
angled at 12mm
flat tip, front opening
26 gauge

K7-5056



Cannulas



Dahan

Nucleus Prolapsing Cannula
angled at 4mm
miniature olive tip with
0.15mm end opening
25 gauge
K7-5058



Chu

Hydrodissection Cannula
flattened, 25 gauge
0.75mm long spatulated tip
K7-5085

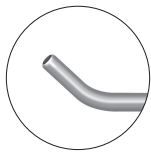

Knolle

Anterior Chamber
Irrigating Cannula
angled at 2mm, front opening
K7-5060 30 gauge
K7-5062 27 gauge
K7-5080 23 gauge

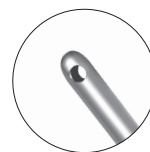

Irrigating Cannula

dual side ports
23 gauge
K7-5095 0.4mm ports
K7-5096 0.5mm ports

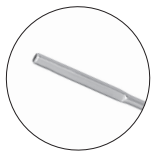

Sauter

Hydrodissection Cannula
vertically flattened tip
front opening, 27 gauge
K7-5082

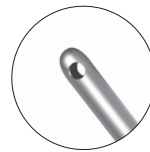

Irrigating Cannula

dual side ports
22 gauge, oval
K7-5097 0.4mm ports

Cannulas



Bracken

Irrigating Cannula
smooth beveled tip
front opening, 19 gauge

K7-5100



Banaji

LASIK Cannula
bullet shaped tip
6 ports for multi-directional
irrigation
25 gauge

K7-5112 smooth

K7-5113 textured



Spatulated

LASIK Cannula
flattened spatulated tip
end opening
26 gauge

K7-5106

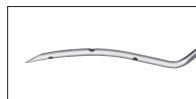

Brierley

LASIK Cannula
closed spatulated tip
6 ports for multi-directional
irrigation
25 gauge

K7-5115



Fukasaku

LASIK Cannula
low profile tip, end opening
23 gauge

K7-5108

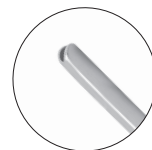

Carter

LASIK Cannula
flattened tip, end opening
25 gauge

K7-5116

Cannulas



Buratto

LASIK Cannula
slightly flattened
one front and two side ports

K7-5117 25 gauge

K7-5118 23 gauge



Labor

A/C Cannula
textured tip at 0.5mm
26 gauge

*Lightly textured tip can be used
for positioning an IOL without
damaging the optic.*

K7-5155

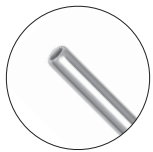

McIntyre

Anterior Chamber Cannula
smooth blunt tip, front opening

K7-5120 23 gauge, straight

K7-5130 23 gauge, angled

K7-5140 26 gauge, straight

K7-5150 26 gauge, angled

K7-5160 30 gauge, straight

K7-5170 30 gauge, angled

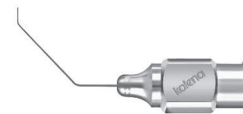
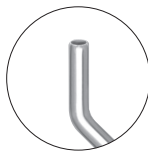

Gimbel

Cortex Aspirating Cannula
end opening
30 gauge

K7-5174

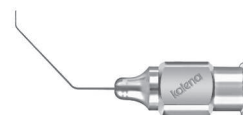

Gimbel

LASIK Polishing Cannula
flattened textured tip
end opening, 30 gauge
*For dislodging and irrigating
particles from the corneal
interface.*

K7-5176

Cannulas

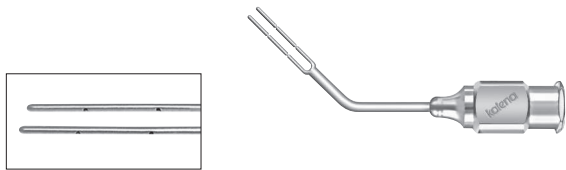

Vidaurri

LASIK Cannula
double-armed
8 irrigating ports
25 gauge
K7-5180 vertical
K7-5181 horizontal



Simcoe

Cortex Extractor
0.4mm side port
21mm long
K7-5232 23 gauge thin wall
K7-5234 21 gauge



Simcoe

Cortex Extractor
0.3mm side port
13mm long, 23 gauge
K7-5220 smooth tip
K7-5221 textured tip



De La O

Aspirating Cannula
0.3mm side port
angled at 12mm
25 gauge thin wall
K7-5236



Simcoe

Cortex Extractor
0.3mm side port
21mm long, 23 gauge
K7-5230 smooth tip
K7-5231 textured tip



Simcoe

Aspiration Cannula
0.3mm side port
21mm long, 22 gauge
oval
K7-5237 smooth tip
K7-5238 textured tip

Cannulas

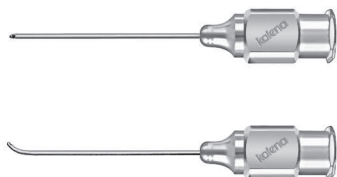
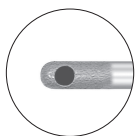

Anis

Cortex Aspirating Cannula
0.4mm side port
finely textured tip
23 gauge thin wall
K7-5240 straight
K7-5241 angled

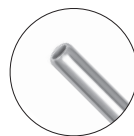

Morrison

Aspirating Cannula
smooth blunt tip
angled at 7mm
end opening
23 gauge
K7-5393

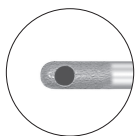

Dahan

Cortex Aspirating Cannula
0.4mm side port
finely textured tip
22 gauge thin wall
K7-5242



Wilbrandt-Binkhorst

Cannula, "U" shape
smooth blunt tip
end opening, 23 gauge
K7-5430 straight
K7-5431 angled left
K7-5432 angled right

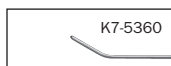

Gills

Aspirating Cannula
smooth blunt tip
end opening
angled, 25 gauge
K7-5360 5mm tip
K7-5370 7mm tip
K7-5380 8mm tip
K7-5390 10mm tip



McIntyre-Binkhorst

Cannula, "J" shape
smooth blunt tip
end opening, 26 gauge
K7-5440 angled right
K7-5445 straight
K7-5450 angled left

Cannulas



Hamill

Irrigating Cannula
double bend with 1mm tip
30 gauge

K7-5452



Feaster

Hydrodissection Cannula
wedge shaped tip
dual side ports
25 gauge

K7-5460



Gimbel

Hydrodissection Cannula
smooth blunt tip
end opening
30 gauge

K7-5455



Fukasaku

HydroChop Cannula
vertically flattened tip with
dual 0.2mm sideports
23 gauge

*For efficient micro incision
nucleus division.*

K7-5462



Gimbel

Irrigating Cannula
blunt tip, angled to side
end opening
26 gauge

K7-5458



Chang

Hydrodissection Cannula
flat tip angled 90°
with beveled opening
27 gauge

K7-5464 standard tip

K7-5466 long tip

Cannulas



Knolle-Pearce

Irrigating Vectis
fluid flow through
three front opening ports
23 gauge loop
K7-5500



Drews

Irrigating Vectis
fluid flow through
one front and two backward
opening ports
23 gauge loop
K7-5510

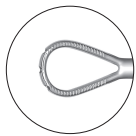

Sheets

Irrigating Vectis
fluid flow through
three front opening ports
serrated, 20 gauge loop
K7-5520

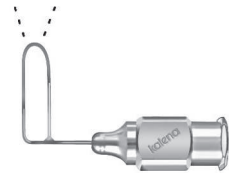

Simcoe

Irrigating Lens Nucleus Loop
two front opening ports
finely serrated, strong curve
25 gauge

K7-5530 right

K7-5531 left

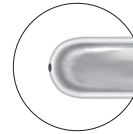

Alfonso-McIntyre

Irrigating Nucleus Spoon
single 0.3mm
front opening port

K7-5532 2.5mm wide

K7-5533 4.0mm wide



Heslin

Infusion Cannula
textured tip

K7-6700 25 gauge

K7-6710 23 gauge

Cannulas

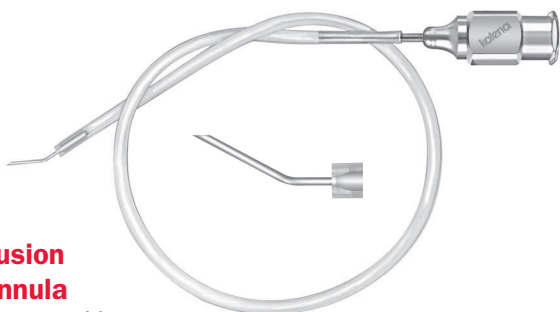

Infusion Cannula

22 gauge with self-retaining tip
K7-6711

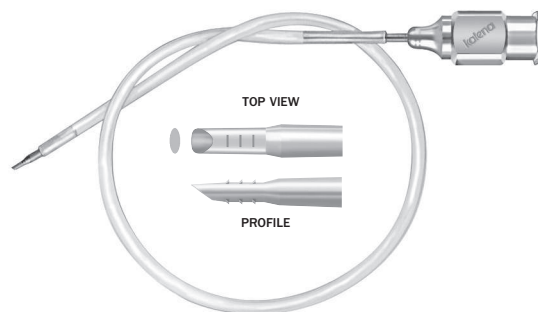

Brierley

Chamber Maintainer
20 gauge tapered oval tip with self retaining fins
titanium
K7-6715



Drof

Infusion Cannula
18 gauge with a 22 gauge, 3mm long tip
K7-6725

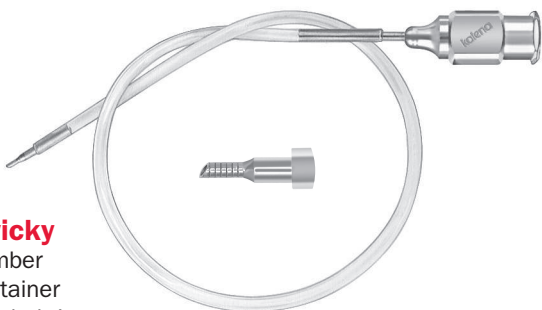

Lewicky

Chamber Maintainer
threaded tip
20 gauge
K7-6713

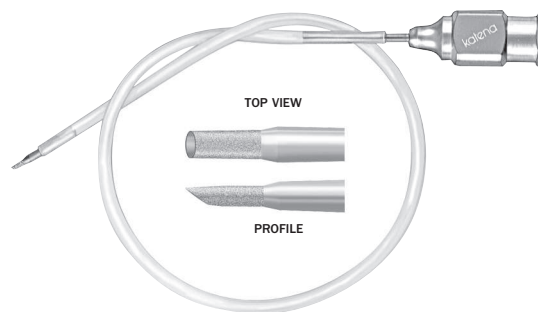

Dahan-Blumenthal

Anterior Chamber Maintainer
20 gauge, tapered oval tip
Finely textured tip for retention in incision.
K7-6717

Infusion Handles

McIntyre

Infusion Handle
autoclavable plastic
male/tubing connectors
7.5cm long

K7-6750

K7-6748 silicone tubing and adaptor



Kansas

Infusion Handle
male/male connectors
7.5cm long

K7-6795



Katena

Infusion Handle
male/tubing connectors
K7-6800 11.5cm long
K7-6801 7.5cm long



Katena

Infusion Handle
K7-6805 male/male connectors
K7-6806 male/female connectors



Bimanual I/A



This system is designed for bimanual irrigation and aspiration of residual cortex after phacoemulsification and removal of the nucleus. The handpieces are color coded and designed for comfortable hand position when used through two opposing side port incisions.

Irrigation Handpieces

with female connector, blue color

- K7-5836** 23 gauge, dual 0.3mm side ports
- K7-5838** 22 gauge, dual 0.4mm side ports, oval
- K7-5839** 21 gauge, dual 0.5mm side ports, oval
- K7-5840** 21 gauge, dual 0.5mm side ports

Irrigation and Aspiration Handles

For use with standard luer-lock cannulas.

- K7-5890** Aspiration Handle
male/male fitting, magenta color
- K7-5892** Irrigation Handle
male/female fitting, blue color

Aspiration Handpieces

with male connector
side port facing into curve
magenta color

- K7-5804** 23 gauge, 0.3mm port
- K7-5805** 23 gauge, 0.3mm port, textured tip
- K7-5810** 21 gauge, 0.35mm port
- K7-5811** 21 gauge, 0.35mm port, textured tip
- K7-5814** 21 gauge, 0.4mm port
- K7-5815** 21 gauge, 0.4mm port, textured tip
- K7-5816** 22 gauge, 0.3mm port, oval
- K7-5817** 22 gauge, 0.3mm port, oval, textured tip
- K7-5818** 21 gauge, 0.4mm port, oval



Irrigating Manipulators

Bohm

Irrigating Iris Retractor
 21 gauge
 0.75mm diameter collar button
K7-5770



Lu

Irrigating Toric
 Lens Manipulator
 smooth bulbous shaped tip
 end opening
 20 gauge thin wall
K7-5780



Rosenwasser

Irrigating Endothelial Stripper
 thin, semi-circular tip
 end opening irrigation port
 20 gauge thin wall
K7-5897



Irrigating Nucleus Choppers

Hydrochoppers

For precisely controlled fluidics during micro incision and bimanual cataract surgery techniques.



Solid one-piece stainless steel front ends on lightweight aluminum handpieces. For micro incision or bimanual cataract surgery through an incision size of 1.2mm.



Alio "Stinger"
irrigation port facing posteriorly, 20 gauge, oval
K7-5863



Fine
Nucleus Chopper with 1mm long V-shaped tip
20 gauge thin wall
K7-5871



Fukasaku
Small Pupil Snapper Hook wedge shaped inferior edge with blunt tip and front notch for engaging iris
20 gauge thin wall
K7-5873



Rosen
Phaco Splitter wedge shaped inferior edge with blunt tip
20 gauge thin wall
K7-5875



Nichamin
Nucleus Chopper with wedge shaped tip offset 60°
20 gauge thin wall
K7-5877



Chang
Phaco Chopper with modified MicroFinger for horizontal chopping
20 gauge thin wall
K7-5879



Nagahara
Phaco Chopper with wedge shaped inferior edge and round blunt tip
20 gauge thin wall
K7-5881



Nagahara
Phaco Chopper with wedge shaped inferior edge and round blunt tip offset 60°
20 gauge thin wall
K7-5883



Giannetti
Nucleus Chopper and Manipulator with semi-sharp sides and concave inferior surface
20 gauge thin wall
K7-5885

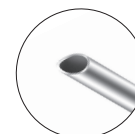

Lindstrom
Irrigator end opening
20 gauge thin wall
K7-5889

I/A System

QUICK Switch System



QuickSwitch I/A Handpiece
K7-6010 male aspiration connector

- For cortical cleanup and removal, aspiration of viscoelastic and infusion of BSS
- Perfectly balanced lightweight handpiece with male and female luer fittings to accommodate tubing connectors
- No “O” rings to change
- Direct fluid flow through handpiece
- Changing tips intraoperatively is a snap with QuickSwitch
- Large selection of I/A tips

Coaxial I/A Tip, straight
side port aspiration
16 gauge irrigation sleeve
with dual side ports

K7-6020 0.3mm aspiration port

K7-6021 0.4mm aspiration port



Coaxial I/A Tip, curved
0.3mm side port aspiration
16 gauge irrigation sleeve
with dual side ports

K7-6023



I/A System



Coaxial I/A Tip, 0.3mm side port aspiration angled 45°
16 gauge irrigation sleeve with dual side ports
K7-6030



Coaxial I/A Tip, 0.3mm side port aspiration angled 90°
16 gauge irrigation sleeve with dual side ports
K7-6033



Coaxial I/A Tip, 0.3mm side port aspiration curved 160°
16 gauge irrigation sleeve with dual side ports
K7-6036



Coaxial I/A Tip, 0.3mm end opening aspiration curved 160°
16 gauge irrigation sleeve with dual side ports
K7-6037



Coaxial I/A Tip for viscoelastic removal, straight, 0.5mm side port aspiration, 16 gauge irrigation sleeve with dual side ports
K7-6045



Coaxial I/A Tip, straight, side port aspiration, silicone irrigation sleeve with dual side ports
K7-6050 0.3mm aspiration port
K7-6051 0.4mm aspiration port



Coaxial I/A Tip, 0.3mm side port aspiration angled 45°
silicone irrigation sleeve with dual side ports
K7-6052



Coaxial I/A Tip, 0.3mm side port aspiration angled 90°
silicone irrigation sleeve with dual side ports
K7-6054



Silicone Irrigation Sleeve
(pkg/6)
K7-6059



Luer adapter
For use with conventional irrigation cannulas.
K7-6060

Eye Spheres

Carter

Sphere Introducer

K8-6000

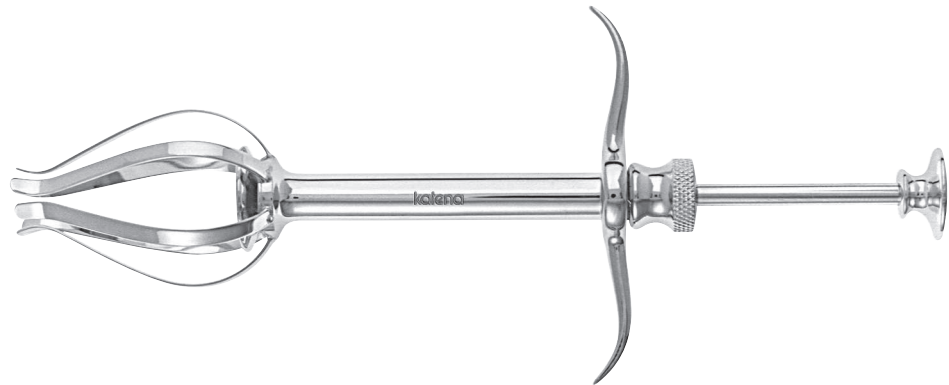

Eye Sphere

solid, clear plastic

K8-6100 10mm

K8-6120 12mm

K8-6140 14mm

K8-6160 16mm

K8-6180 18mm

K8-6200 20mm

K8-6220 22mm



Universal

Conformer

clear plastic

K8-6300 set of four
(1 sm, 1 med, 2 lg)

K8-6310 small

K8-6320 medium

K8-6330 large

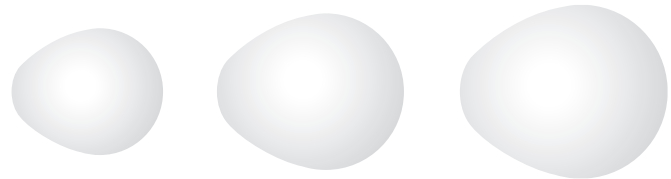

Bipolar Forceps

Jewelers Type

pointed tips

straight

K8-7010 plain

K8-7012 insulated



Bipolar Forceps

Bipolar Forceps

McPherson type
lightly blunted tips
straight

K8-7020

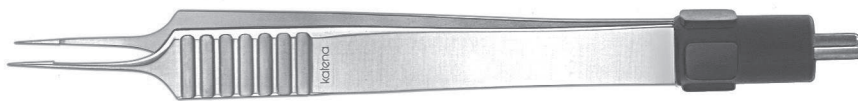

Bipolar Forceps

McPherson type
lightly blunted tips
angled

K8-7021



Bipolar

Coaptation Forceps
pointed tips

K8-7030



Bipolar Cord

autoclavable

K8-7065



Accessories

Marking Tape

autoclavable

For identifying surgical instruments.

K9-1000 red	K9-1050 brown
K9-1010 yellow	K9-1060 blue
K9-1020 orange	K9-1070 green
K9-1030 white	K9-1071 lime green
K9-1035 grey	K9-1080 fluorescent orange
K9-1040 black	K9-1090 fluorescent purple



Vented Tip Guards

autoclavable (pk/100)

For protecting tips of surgical instruments.

K9-1205 assorted colors
K9-1215 white
K9-1225 blue
K9-1235 green
K9-1245 red
K9-1255 yellow
K9-1265 orange

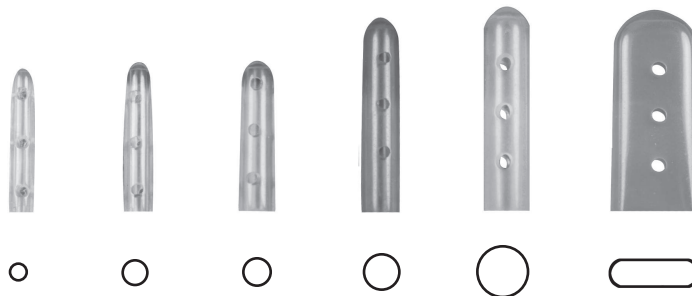

Squeeze Handle

Cleaning Tube

used to flush delicate
mechanized instruments
luer lock connector provided

K9-1350



Sterilizing Cases • Plastic

Sterilizing Case for Diamond Knife

autoclavable plastic
with perforated silicone rack

K2-6555 for one knife

K2-6556 for two knives

Millimeters

160 x 60 x 25

Inches

6 ¼" x 2 ¼" x 1"



Plastic Sterilizing Cases

autoclavable plastic
with silicone finger mat
base, lid and mat are perforated
for steam penetration

Catalog

K9-2018

K9-2020

K9-2025

K9-2030

K9-2040

Size

small, narrow

small

medium

large

large, double level

of Instruments

1-2

2-3

4-6

10-15

20-25

Millimeters

195 x 60 x 25

160 x 70 x 25

200 x 110 x 25

265 x 160 x 25

265 x 160 x 50

Inches

7 ⅝" x 2 ¼" x 1"

6 ¼" x 2 ¾" x 1"

7 ¾" x 4 ¼" x 1"

10 ⅜" x 6 ⅜" x 1"

10 ⅜" x 6 ⅜" x 2"



K9-2020

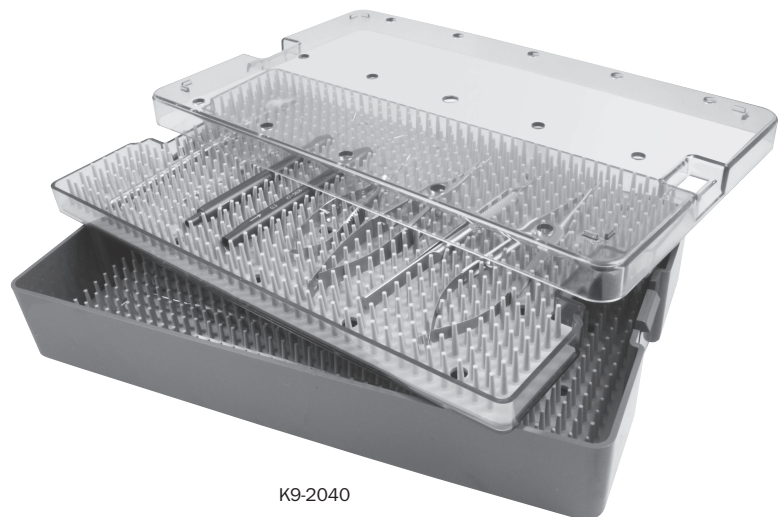

K9-2040

Sterilizing Cases • Plastic

Sterilizing Case

autoclavable plastic
with perforated silicone rack
base, lid and rack are perforated
for steam penetration

Accommodates 1 instrument.

K9-2022

Millimeters

158 x 70 x 25

Inches

6 ¼" x 2 ¾" x 1"



Sterilizing Case for Knives

autoclavable plastic
with silicone racks
base and lid are perforated
for steam penetration

Accommodates 3 knives.

K9-2024

Millimeters

198 x 70 x 25

Inches

7 ¾" x 2 ¾" x 1"



Sterilizing Cases • Stainless Steel

Katena Sterilizing Case, small
stainless steel
base, lid and mat are perforated
for steam penetration
Accommodates 8 to 12
microsurgical instruments.

K9-2100 complete
K9-2120 silicone mat only

Millimeters	Inches
210 x 125 x 20	8 ¼" x 5" x ¾"

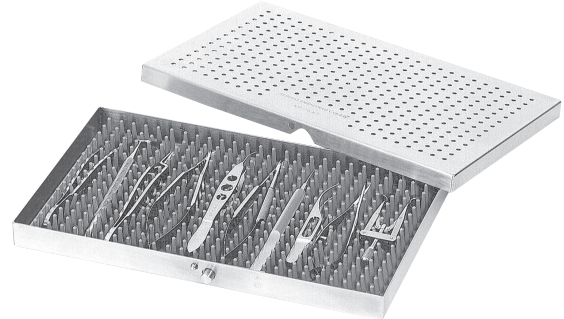

Katena Sterilizing Case, medium
stainless steel
base, lid and mats are perforated
for steam penetration
includes 2 silicone mats, rack for
4 cannulas and a rack for 4 delicate
hooks or knives
Accommodates 20 to 25
microsurgical instruments.

K9-2200

Millimeters	Inches
320 x 220 x 20	12 ½" x 8 ¾" x ¾"

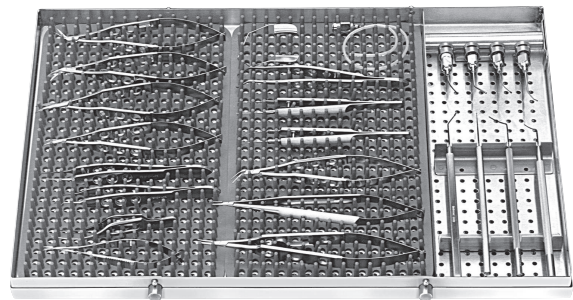

Katena Sterilizing Case, large
stainless steel
base, lid and mats are perforated
for steam penetration
includes 3 silicone mats, racks for 8
cannulas and a rack for 4 delicate
hooks or knives
Accommodates 30 to 40
microsurgical instruments.

K9-2300

Millimeters	Inches
360 x 295 x 20	14 ¼" x 11 ½" x ¾"

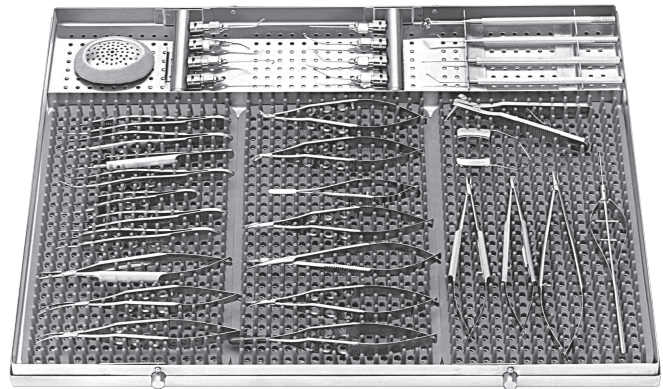

Sterilizing Cases • Aluminum

Aluminum Sterilizing Cases, single autoclavable anodized aluminum with silicone finger mat base, lid, and mat are perforated for steam penetration

Catalog #	Size	# of Instruments	Millimeters	Inches
K9-2320	small	6-8	206 x 115 x 19	8 1/8" x 4 1/2" x 3/4"
K9-2330	medium	10-17	247 x 206 x 19	9 3/4" x 8 1/8" x 3/4"
K9-2340	large	16-20	327 x 225 x 25	12 7/8" x 8 7/8" x 1"

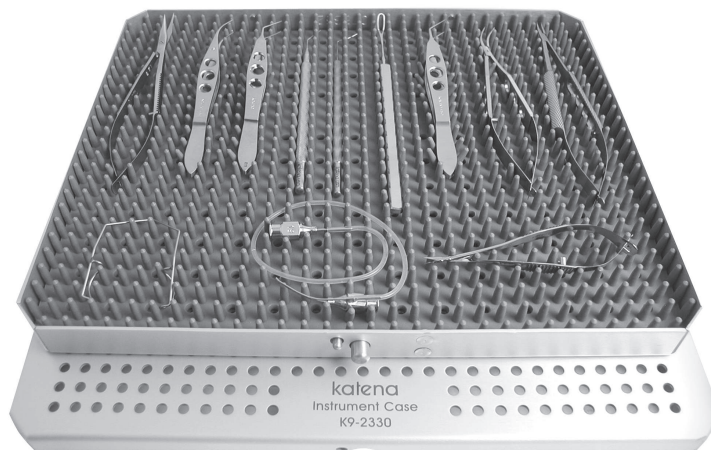

Silicone Finger Mat

with "S-Channels" on underside
Utilizing a special design which improves air flow beneath the mat, making the drying process more efficient and thorough.

- K9-2325** for use with Instrument Case, aluminum, small (K9-2320)
- K9-2335** for use with Instrument Case, aluminum, medium (K9-2330)
- K9-2345** for use with Instrument Case, aluminum, large (K9-2340)

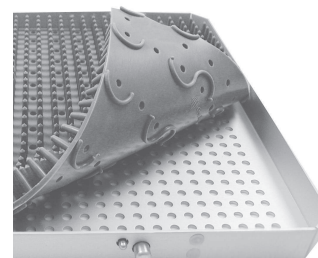

Sterilizing Cases • Aluminum

Aluminum Sterilizing Case, double anodized aluminum double level with a side compartment for larger items includes removable tray and 4 silicone mats base, lid, tray and mats are perforated for steam penetration Accommodates 35 to 50 microsurgical instruments.
K9-2350

Millimeters 325 x 265 x 42
Inches 12 ¾" x 10 ½" x 1 ⅝"



Instrument Rack anodized aluminum Holds and protects delicate hooks, manipulators and cannulas. Fits into upper or lower tray of double level sterilizing case (K9-2350) shown above Accommodates 5 cannulas, 6 hooks, manipulators, etc.
K9-2355

Millimeters 202 x 115 x 15
Inches 8" x 4 ½" x ½"

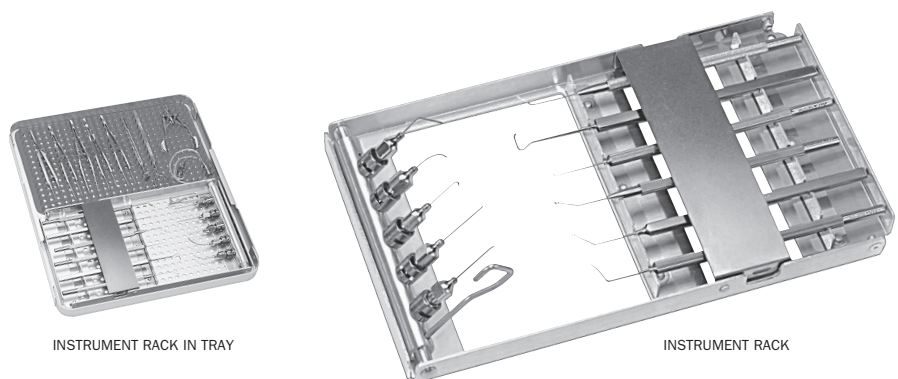

INSTRUMENT RACK IN TRAY

INSTRUMENT RACK

Eye Shields

Fox

Aluminum
Eye Shield
(bx/50)
K9-6000

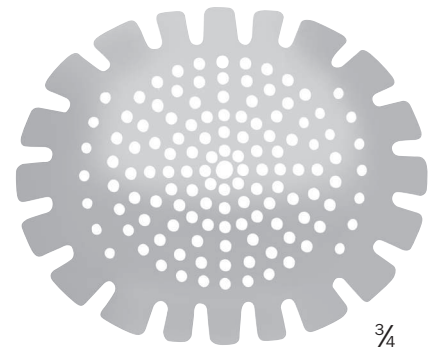
 $\frac{3}{4}$

Fox

Aluminum Eye Shield
with garter
assorted colors
(bx/50)

K9-6010 adult
K9-6015 pediatric
K9-6030 garter only, assorted*
K9-6040 garter only, white*

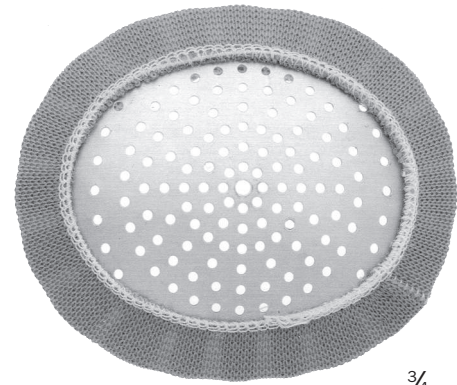
 $\frac{3}{4}$

*Caution: Garters contain latex which may cause allergic reactions.

Universal

Eye Shield
clear plastic
(pk/12)
K9-6050

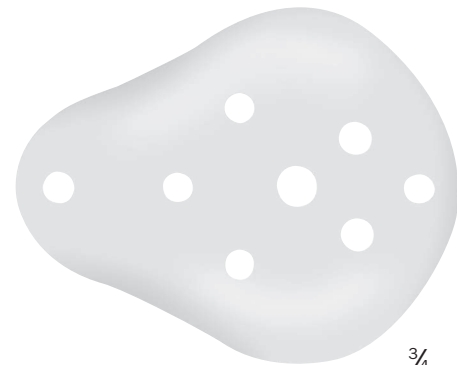

 $\frac{3}{4}$

Pressure Reducer

Pin Hole

Eye Shield
white plastic
(pk/12)

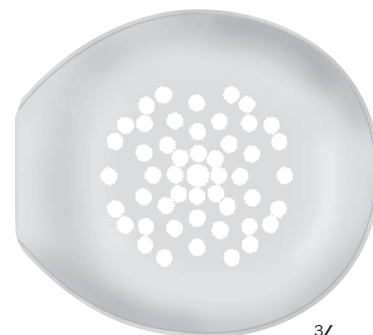
K9-6100



3/4

Honan Balloon

Intraocular Pressure Reducer
with relief valve

K9-8410 complete*

K9-8411 headband only, reusable*

K9-8412 headband, latex free
disposable (bx/12)



*Caution: This product contains latex which may cause allergic reactions.

Tonometer

Schiotz
Tonometer
autoclavable
with certificate of accuracy
K9-8500

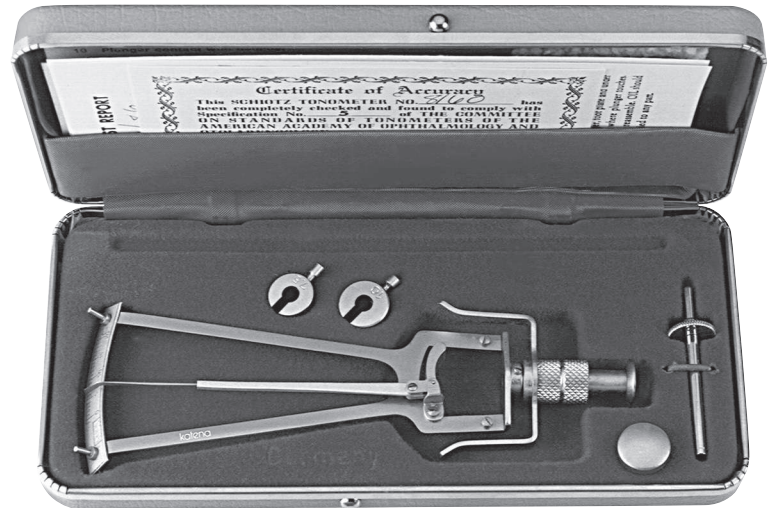

Handles

Super Blade

sterile, disposable (pk/12)

K20-1760 15°

K20-1770 30°

K20-1780 45°



15°



30°



45°

ENLARGED



K2-5000
(see page 23)

Chuck Handle

round, serrated

K20-1910 10cm

K20-1920 7.5cm

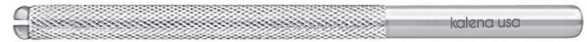

Bard-Parker Handle

for disposable slot blades

K20-1950 #3

K20-1970 #9



Bard-Parker Blade

sterile, disposable (pk/50)

K20-1981 #11

K20-1985 #15

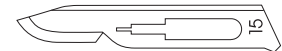

Barron Vacuum Trephines & Punches

Barron Radial Vacuum Trephine for the recipient cornea

CAT. NO.	DIAMETER
K20-2050	6.0mm
K20-2052	6.5mm
K20-2054	7.0mm
K20-2055	7.25mm
K20-2056	7.5mm
K20-2057	7.75mm
K20-2058	8.0mm
K20-2059	8.25mm
K20-2060	8.5mm
K20-2061	8.75mm
K20-2062	9.0mm

sterile, disposable



Each sterile, disposable trephine is supplied completely assembled and ready for use.



Barron Vacuum Punch for the donor cornea

CAT. NO.	DIAMETER	CAT. NO.	DIAMETER
K20-2100	6.0mm	K20-2108	8.0mm
K20-2102	6.5mm	K20-2109	8.25mm
K20-2103	6.75mm	K20-2110	8.5mm
K20-2104	7.0mm	K20-2111	8.75mm
K20-2105	7.25mm	K20-2112	9.0mm
K20-2106	7.5mm	K20-2113	9.25mm
K20-2107	7.75mm	K20-2114	9.5mm

sterile, disposable

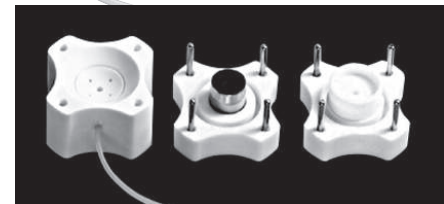

CUTTING
BLOCK

TREPHINE
BLADE

SEATING
RING

Barron Non-Vacuum Punches • A/C

Barron Non-Vacuum Punch for the donor cornea

CAT. NO.	DIAMETER	CAT. NO.	DIAMETER
K20-2070	6.0mm	K20-2078	8.0mm
K20-2072	6.5mm	K20-2079	8.25mm
K20-2073	6.75mm	K20-2080	8.5mm
K20-2074	7.0mm	K20-2081	8.75mm
K20-2075	7.25mm	K20-2082	9.0mm
K20-2076	7.5mm	K20-2083	9.25mm
K20-2077	7.75mm	K20-2084	9.5mm

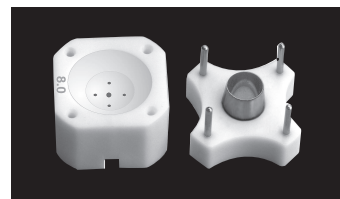
CUTTING
BLOCKTREPINE
BLADE

sterile, disposable

Barron Artificial Anterior Chamber

holds a (14-18mm) donor corneal graft
sterile, disposable
*To cut the donor cornea from
the epithelial side.*

K20-2125

K20-2126 stainless steel base,
reusable

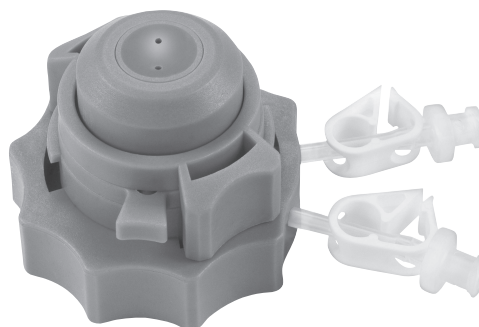

K20-2125

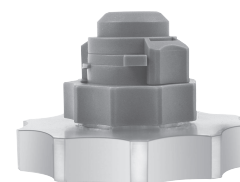

shown with K20-2126 base

Vidaurri

Fluid Retention Ring
double-walled vacuum ring
8.7mm I.D.

K20-2135



Trephine Blades

Elliot

Scleral Trephine Blade

K2-7500 1.0mm diameter

K2-7510 1.5mm diameter

K2-7520 2.0mm diameter



Corneal Trephine Blades and Handles



DIAMETER	NON-STERILE BLADES	STERILE BLADES	NON-STERILE HANDLES
6.0mm	K2-8014	K20-2150	K2-8114
6.5mm	K2-8016	K20-2152	K2-8116
6.75mm	K2-8017	K20-2153	K2-8117
7.0mm	K2-8018	K20-2154	K2-8118
7.25mm	K2-8019	K20-2155	K2-8119
7.5mm	K2-8020	K20-2156	K2-8120
7.75mm	K2-8021	K20-2157	K2-8121
8.0mm	K2-8022	K20-2158	K2-8122
8.25mm	K2-8023	K20-2159	K2-8123
8.5mm	K2-8024	K20-2160	K2-8124
8.75mm	K2-8025	K20-2161	K2-8125
9.0mm	K2-8026	K20-2162	K2-8126
9.5mm	K2-8028	K20-2164	K2-8128
14.0mm	K2-8046	—	—
16.0mm	—	K20-2178	—



Universal Trephine Handle

Adjustable handle for use with 7.0 to 9.5mm trephine blades

K2-8100



Disposable Knives

Performance

Microsurgical Knives



MVR Knife

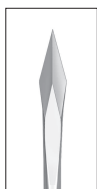

- K20-2284** 1.2mm, 20 ga.
- K20-2286** 1.5mm, 19 ga.
- K20-2287** 0.8mm, 23 ga.
- K20-2288** 0.6mm, 25 ga.

Sideport Knife

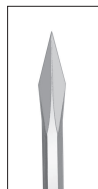

- K20-2294**
1mm, angled

Stab Knives



- K20-2310**
15° edge



- K20-2311**
22.5° edge



- K20-2312**
30° edge



- K20-2313**
45° edge

Phaco Knife

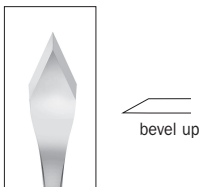

- K20-2318** 1.8mm, angled
- K20-2322** 2.8mm, angled
- K20-2324** 3.0mm, angled
- K20-2326** 3.2mm, angled
- K20-2365** 1.8/2.2mm angled trapezoidal

Clear Corneal Knife

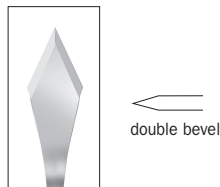

- K20-2344** 2.8mm, angled
- K20-2346** 3.0mm, angled
- K20-2348** 3.2mm, angled

Crescent Knife



- K20-2402** 2mm wide angled, bevel up
- K20-2406** 2mm wide angled, double bevel

LRI Knife

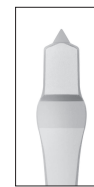

- K20-2560**
600 micron restricted depth guard

Performance knives are supplied sterile and packaged 5 per box.

Disposable Blades

Performance Microsurgical Blades



K20-1910 handle, 10cm
K20-1920 handle, 7.5cm

Miniature Blades

K20-2464 #64



K20-2465 #65



K20-2467 #67



K20-2469 #69



Lamellar Blade

K20-2466 #66



Sclerotome Blade

K20-2457 #57



Phaco Blade

K20-2475 3.0mm, str.



K20-2476 3.0mm, ang.



K20-2478 3.2mm, ang.



Implant Blade

K20-2488 5.2mm



K20-2490 6.2mm



Super Sharp

K20-2440 15°, 3mm



K20-2442 15°, 5mm



Performance blades are supplied sterile and packaged 5 per box.

Disposable Cannulas

Anesthesia Cannulas

Peribulbar Needle

sterile, disposable (bx/10)

K20-3010 25 gauge, 16mm long

K20-3014 25 gauge, 22mm long

K20-3020 23 gauge, 32mm long

K20-3023 25 gauge, 32mm long

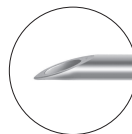

Retrobulbar Needle

sterile, disposable (bx/10)

K20-3030 25 gauge, 38mm long

K20-3040 23 gauge, 38mm long

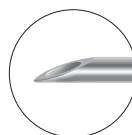

Sub-Tenon's Cannula

gently curved, flat tip

sterile, disposable (bx/10)

For atraumatic entry into

Sub-Tenon's space to inject
local anesthetic.

K20-3050 19 gauge, 25mm

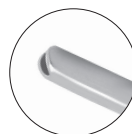

Anterior Chamber Cannulas

Air Injection / Rycroft Cannula

angled at 5mm

sterile, disposable (bx/10)

K20-3100 30 gauge

K20-3101 27 gauge

K20-3103 25 gauge

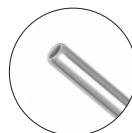

Arbisser

Anterior Chamber Cannula

angled at 7mm

sterile, disposable (bx/10)

K20-3110 30 gauge

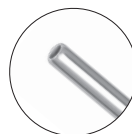

Disposable Cannulas

Robins

Anterior Chamber Cannula
sterile, disposable (bx/10)
*Barrel at the tip helps to
seal the incision.*

K20-3115 30 gauge



Air Injection Cannula

straight
sterile, disposable (bx/10)

K20-3104 27 gauge, 22mm long

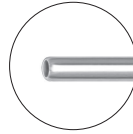

Viscoelastic Injection Cannula

angled at 8mm
sterile, disposable (bx/10)

K20-3105 30 gauge

K20-3106 27 gauge

K20-3107 25 gauge

K20-3108 23 gauge

K20-3109 21 gauge



Viscoelastic Injection Cannula

angled at 10mm
sterile, disposable (bx/10)

K20-3120 30 gauge

K20-3121 27 gauge

K20-3122 26 gauge

K20-3125 25 gauge

K20-3126 23 gauge



Disposable Cannulas

Cystotome Cannulas

Cystotome

straight, 16mm long
sterile, disposable (bx/10)

K20-3056 25 gauge

K20-3057 27 gauge



Cystotome

formed
12mm long
sterile, disposable (bx/10)

K20-3062 27 gauge

K20-3066 25 gauge

K20-3068 23 gauge



Cystotome

curved, 16mm long
sterile, disposable (bx/10)

K20-3072 27 gauge



Reverse Cystotome

formed, 12mm long
sterile, disposable (bx/10)
*Tip bent toward port
for downward irrigation.*

K20-3070 25 gauge



Disposable Cannulas

Capsulorrhexis Cystotome

formed, 8mm long
sterile, disposable (bx/10)
*Special offset, beveled tip aids
in control during CCC.*

K20-3074 25 gauge

K20-3076 27 gauge



Giannetti

Posterior Capsulorrhexis Cannula
90° angled tip
sterile, disposable (bx/10)

K20-3080 30 gauge



Hydrodissection Cannulas

Giannetti

Hydrodissection Cannula
formed, flattened tip angled at 13mm
sterile, disposable (bx/10)

K20-3128 26 gauge



Giannetti

"Big Spurt"
Hydroexpression Cannula
angled 40° at 12mm
textured tip
sterile, disposable (bx/10)

K20-3139 21 gauge



Disposable Cannulas

Hydrodissection

flattened tip, angled
sterile, disposable (bx/10)

K20-3162 25 gauge, 7mm

K20-3163 25 gauge, 8mm

K20-3164 27 gauge, 8mm



Hydrodissection

vertically flattened tip, curved
sterile, disposable (bx/10)

K20-3166 27 gauge, 22mm long

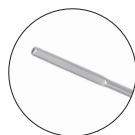

Chang

Hydrodissection Cannula
flattened tip, angled 90°
beveled opening
sterile, disposable (bx/10)

K20-3168 27 gauge



J-Shaped Hydrodissection

flattened tip, straight
sterile, disposable (bx/10)

K20-3170 25 gauge

K20-3171 27 gauge



Disposable Cannulas

Cortex Removal Cannulas

Giannetti

J-Shaped
angled 10° at 15mm
sterile, disposable (bx/10)

K20-3172 25 gauge

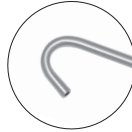

J-Shaped

sterile, disposable (bx/10)

K20-3175 25 gauge, angled 45° at 10mm

K20-3174 25 gauge, straight



McIntyre-Binkhorst Cannula

angled at 12mm
sterile, disposable (bx/10)

K20-3176 25 gauge, right

K20-3177 25 gauge, left



Simcoe

Cortex Extractor
13mm long, 0.3mm port
sterile, disposable (bx/10)

K20-3180 23 gauge

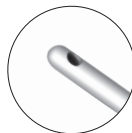

Disposable Cannulas

Simcoe

Cortex Extractor
curved, 22mm long
0.4mm oval port
sterile, disposable (bx/10)

K20-3182 23 gauge

K20-3184 21 gauge

K20-3185 23 gauge, polishing tip

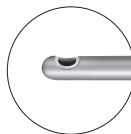

Simcoe I/A

Irrigation-Aspiration Cannula
0.3mm aspiration port
sterile, disposable (bx/3)

K20-3190 23 gauge, thin-wall

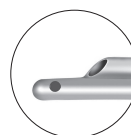

Charleux

Cortex Extractor
16mm long
end opening, beveled
sterile, disposable (bx/10)

K20-3186 23 gauge

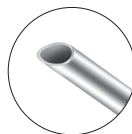

Bimanual

Irrigating Cannula
22mm long
end opening, beveled
sterile, disposable (bx/10)

K20-3188 21 gauge

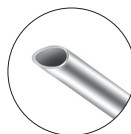

Disposable Cannulas

Capsule Polishing Cannulas

Kratz

Capsule Polisher
end opening
angled at 7mm
sterile, disposable (bx/10)
K20-3203 23 gauge

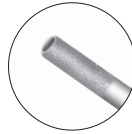

Robins-Kratz

Scratcher
end opening, lightly angled
textured tip
sterile, disposable (bx/10)
K20-3204 22 gauge



Kratz

Capsule Polisher
closed tip with sideport
textured tip
angled at 7mm
sterile, disposable (bx/10)
K20-3213 23 gauge
K20-3215 21 gauge

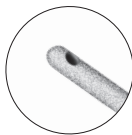

Olive Polisher

end opening
angled at 10mm
textured tip
sterile, disposable (bx/10)
K20-3217 23 gauge

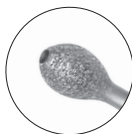

Silicone Tip Cannula

angled at 8mm
sterile, disposable (bx/10)
K20-3220 27 gauge



Disposable Cannulas

Irrigating Cannulas

Bishop-Harmon

flattened tip
angled at 8mm
sterile, disposable (bx/10)

K20-3142 19 gauge



Chamber Maintainer

threaded tip
sterile, disposable (bx/10)

K20-3271 25 gauge

K20-3273 23 gauge

K20-3276 20 gauge

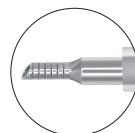

Lacrimal Cannula

19 gauge tapered to 23 gauge
12mm from tip
sterile, disposable (bx/10)

K20-3280

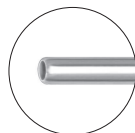

Irrigating Vectis

4mm wide
two front opening ports
sterile, disposable (bx/10)

K20-3252 25 gauge

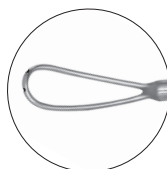

Disposable Cannulas

Refractive Cannulas

LASIK Cannula

formed at 11mm
flattened
sterile, disposable (bx/10)
K20-3240 23 gauge



LASIK Cannula

formed at 9mm
flattened
sterile, disposable (bx/10)
K20-3242 25 gauge



LASIK Cannula

formed at 9mm
4 ports, end opening
sterile, disposable (bx/10)
K20-3244 27 gauge

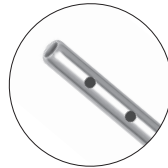

John IntraLasik® Cannula

flat tip, angled at 10mm
sterile, disposable (bx/10)
K20-3151 27 gauge

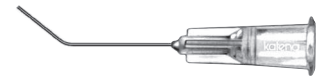

Miscellaneous

Facial Infiltration Needle

sterile, disposable (bx/10)
K20-3000 30 gauge, 16mm

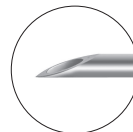

Disposable Instruments

Sinskey

IOL Manipulator
0.2mm diameter tip
sterile, disposable (bx/3)

K20-3800 straight

K20-3801 angled

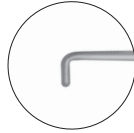

Push-Pull

Manipulator
angled at 10mm
sterile, disposable (bx/3)

K20-3841

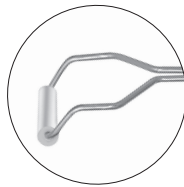

Rubenstein

Corneal Roller
9mm wide
sterile, disposable (bx/3)

K20-3845

Disposable Instruments

Iris Retractor

Flexible
sterile, disposable
K20-3890 set of 5
K20-3892 5 sets of 5

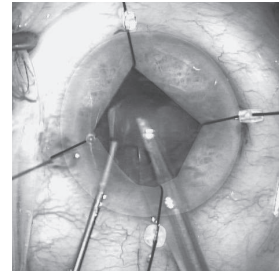
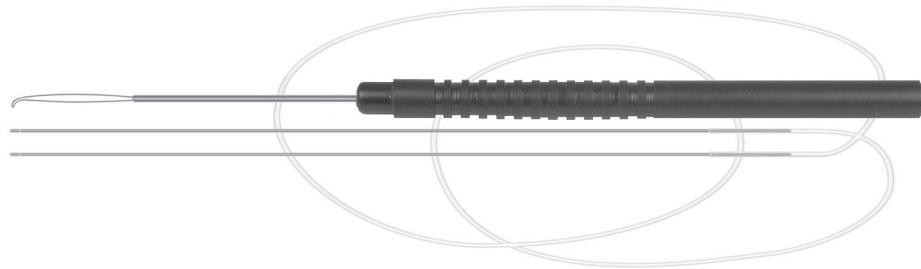

Image courtesy of D.F. Chang, MD

Lacrimal

Intubation Set
with retrieving hook
sterile, disposable (bx/3)
K20-3900



Marking Pen

Gentian Violet
sterile, disposable (pk/10)
K20-4500 fine tip
K20-4501 broad tip
K20-4502 extra fine tip



K20-4500

Disposable Sponges

K-Sponge® Spears and Points

Hydrocellulose Sponge
 triangular shaped sponge mounted
 on fluorescent yellow plastic handle
 sterile, disposable
 packaged 10 sponges per pouch
 15 pouches per box

K20-5000 spears (with handle)

K20-5005 points (without handle)



K-Sponge® II Spears

Synthetic Sponge (PVA), lint free
 triangular shaped sponge
 mounted on blue plastic handle
Recommended for corneal surgery.
 sterile, disposable
 packaged 5 sponges per pouch
 20 pouches per box

K20-5010



LASIK Eye Drains

Chayet LASIK Drain

for nasally hinged flaps
 thin synthetic (PVA) sponge with a 10mm central opening
Used to prevent hydration of the stromal bed during laser ablation.
 sterile, disposable
 packaged 1 drain per pouch
 20 pouches per box

K20-5021

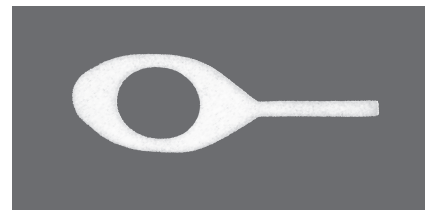

Disposable Sponges

Instrument Wipe and Corneal Light Shield

Katena Instrument Wipes are sterile sponges for wiping delicate instrument tips during microsurgical procedures. When moistened, the non-shedding sponge becomes very smooth, soft and pliable.

A free Corneal Light Shield is included with each Instrument Wipe. When placed on the cornea, the moistened light shield prevents potentially harmful light rays from reaching the retina.

Katena Instrument Wipe and Corneal Light Shield

sterile, disposable
packaged one (1) wipe and one (1) corneal shield
per pouch, 20 pouches per box

K20-5040

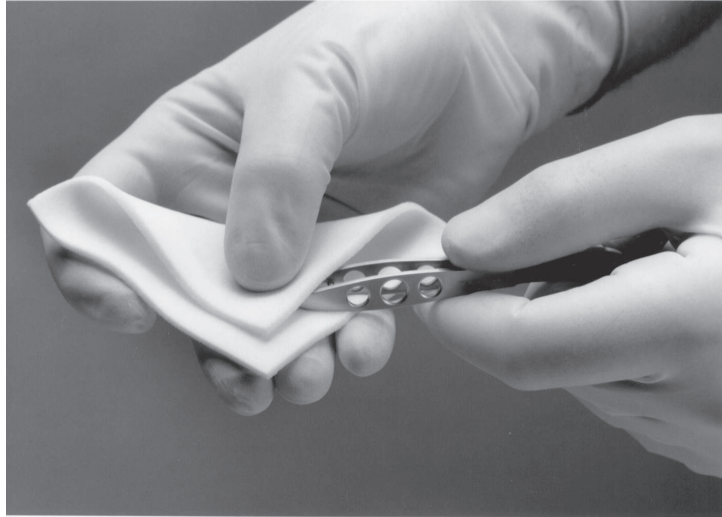

Ocular Surface Tissue

AMBIODisk™

Dehydrated Amniotic Membrane Office - based, Overlay Graft

For the in-office treatment of persistent epithelial defects.

5 year shelf life. Room temperature storage.



9mm diameter



12mm diameter



15mm diameter



Conventional Uses

- Non-healing epithelial defects
- Neurotrophic ulcerations
- Acute chemical/thermal burns
- Corneal erosions and perforations
- Post-infectious keratitis

Biostructurally Intact

- Contains an intact epithelial, columnar cell matrix on the surface of the basement membrane.
- Maintains an intact dense basement membrane.
- Produces a loose collagen layer bordered by retained fibroblasts.
- Easily retained with a bandage contact lens.

Catalog Number & Description

- AD-5090** 9mm diameter Ambio2™ Disk (35 microns)
- AD-5012** 12mm diameter Ambio2™ Disk (35 microns)
- AD-5150** 15mm diameter Ambio2™ Disk (35 microns)
- AF-1150** 15mm diameter Ambio5® Disk (100 microns)

(Products may not be available in all markets.)

Ocular Surface Tissue

AMBIO²

Single Layer Dehydrated Amniotic Membrane

35 Microns Nominal Thickness

A single layer of native dehydrated amniotic membrane for the regeneration of ocular surface tissues and cells.

5 year shelf life. Room temperature storage.

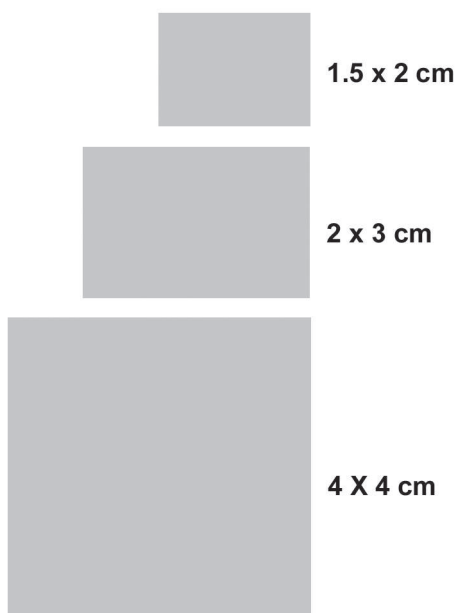

(Products may not be available in all markets.)



Catalog Number & Description

AD-5120 1.5 x 2 cm Ambio2™ Amniotic Membrane

AD-5230 2 x 3 cm Ambio2™ Amniotic Membrane

AD-5440 4 x 4 cm Ambio2™ Amniotic Membrane

Conventional Uses

- Pterygium excision
- Conjunctival chalasis
- Chemical & thermal burns
- Corneal ulcers
- Bullous keratopathy

Biostructurally Intact

- Contains intact cell matrices on the surface of the basement membrane.
- Maintains an intact dense basement membrane.
- Yields a loose collagen layer bordered by retained fibroblasts.

Ocular Surface Tissue

AMBIO5®

Multi-Layer Dehydrated Amniotic Membrane

Includes the Chorion Layer

100 Microns Nominal Thickness

A more robust, native dehydrated amniotic membrane for the regeneration of ocular surface tissues and cells.

5 year shelf life. Room temperature storage.

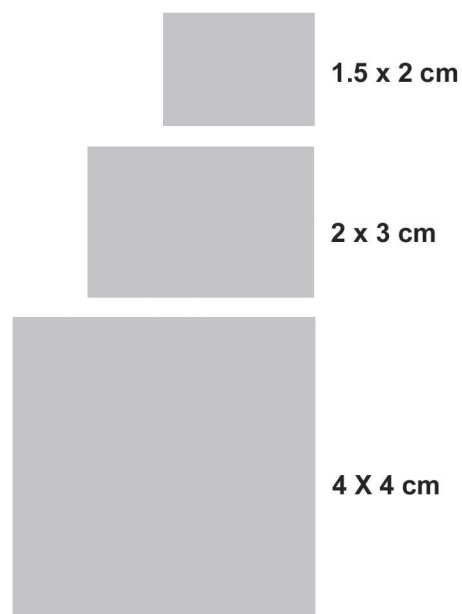
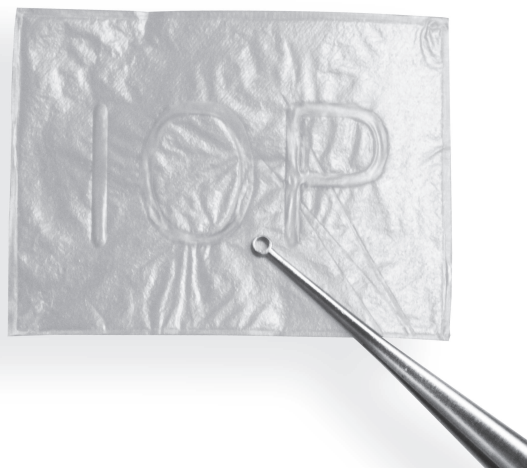

Catalog Number & Description

AF-1120 1.5 x 2 cm Ambio5® Amniotic Membrane Graft

AF-1230 2 x 3 cm Ambio5® Amniotic Membrane Graft

AF-1440 4 x 4 cm Ambio5® Amniotic Membrane Graft

Conventional Uses

- Vast pterygium excision
- Fornix reconstruction
- Anterior segment patch graft
- Conjunctivoplasty

Biostructurally Intact

- Contains vital intact cell matrices on the surface of the membranes.
- Yields a substantially thicker, more intact placental graft.
- Yields a surgical graft with superior tectonic support, biostructure and absorption profile.

(Products may not be available in all markets.)

Glaucoma Drainage Device

Molteno3® Glaucoma Drainage Device

The new Molteno3® is the result of 30 years of clinical expertise with the tube plate and principle pioneered by Professor Anthony Molteno.

Conventional Use

Reduce intraocular pressure in severe and complex cases of Glaucoma.

New Enhancements

- Anterior suture hole replacement
- Pressure ridge profile reduced by 0.55mm for less potential conjunctival erosion
- Thinner contour plate



Product Code & Description

M3-185 Molteno3® 185sq. mm

M3-245 Molteno3® 245sq. mm

(Products may not be available in all markets.)

For glaucoma patch grafts please see Tutoplast on pages 204, 205 & 206

Molteno3® is a registered trademark of Molteno Ophthalmic Ltd and is used with permission.

Glaucoma Patch Grafts

Tutoplast® Human Pericardium Patch Graft

400 - 500 Microns Nominal Thickness

For covering a tube to prevent conjunctival erosion in glaucoma shunt surgery.

Tutoplast® processed allografts are virally safe, dehydrated, sterile, human tissue grafts.

5 year shelf life. Room temperature storage.



1.5 x 1.5 cm



1 x 2.5 cm



2 x 3 cm

Conventional Uses

- Drainage implant or valve implantation
- Repair of leaking or overfiltering blebs
- Repair of corneo sclera fistulas

Biostructurally Intact

Low profile collagen with a multi-directional matrix, for superior surgical handling and suture utility.

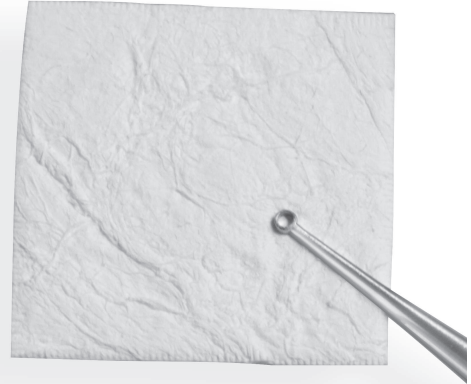

Catalog Number & Description

- 68250** 1.5 x 1.5 cm Tutoplast® Pericardium
68256 1 x 2.5 cm Tutoplast® Pericardium
68260 2 x 3 cm Tutoplast® Pericardium

(Products may not be available in all markets.)

Tutoplast® is a registered trademark of RTI Biologics and is used with permission.

Glaucoma Patch Graft

Tutoplast® Human Sclera Patch Graft

1mm Nominal Thickness

For covering a tube to prevent conjunctival erosion in glaucoma shunt surgery.

Tutoplast® processed allografts are virally safe, dehydrated, sterile, human tissue grafts.

5 year shelf life. Room temperature storage.

 **0.5 x 0.8 cm**

 **0.6 x 1.0 cm**

 **1 x 3 cm**

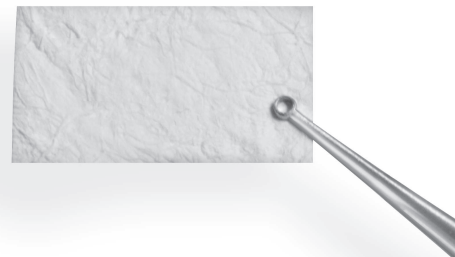

Catalog Number & Description

68333 0.5 x 0.8 cm Tutoplast® Sclera

68337 0.6 x 1.0 cm Tutoplast® Sclera

68334 1 x 3 cm Tutoplast® Sclera

Conventional Uses

- Drainage implant or valve implantation
- Repair of leaking or overfiltering blebs
- Repair of corneo sclera fistulas

(Products may not be available in all markets.)

Biostructurally Intact

High profile collagen with a multi-directional matrix.
For superior surgical handling and suture utility.

Tutoplast® is a registered trademark of RTI Biologics and is used with permission.

Glaucoma Patch Graft

Tutoplast® Human Clear Cornea Patch Graft

230 - 320 Microns Nominal Thickness, Pre-Hydration

For covering a tube to prevent conjunctival erosion in glaucoma shunt /valve surgery.

Dehydrated, 5 year shelf life. Room temperature storage.



1/4 Cornea



1/3 Cornea



1/2 Cornea

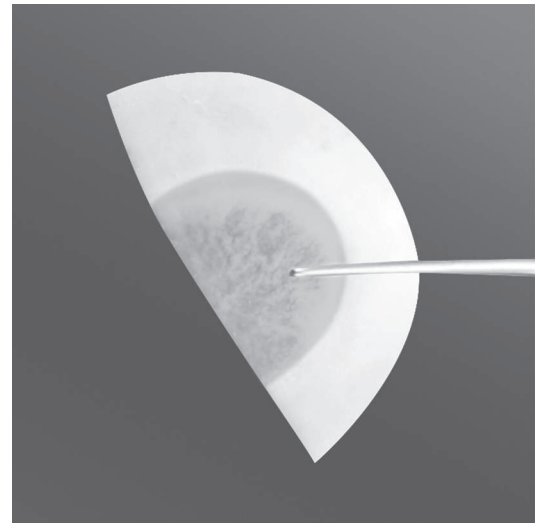

Conventional Uses

- Drainage implant or valve implantation
- Repair of leaking or over-filtering blebs
- Repair of corneoscleral fistulas

Biostructurally Intact

Tutoplast® processed donor cornea retains the strength and durability of fresh cornea as well as a scleral rim for optimal surgical handling and shaping.

(Products may not be available in all markets.)

Catalog Number & Description

- 68328** Tutoplast® Clear Cornea with Sclera, 1/4
- 68329** Tutoplast® Clear Cornea with Sclera, 1/3
- 68330** Tutoplast® Clear Cornea with Sclera, 1/2

Tutoplast® is a registered trademark of RTI Biologics and is used with permission.

Glaucoma Patch Graft

KeraSys™ Bioengineered Lamellar Patch Graft

150 Microns nominal thickness (when hydrated)

For covering a tube to prevent conjunctival erosion in glaucoma tube shunt surgery.

18 month shelf life. Room temperature storage.



1 x 1.5 cm

Conventional Uses

- Drainage implant or valve implantation
- Repair of leaking or over-filtering blebs
- Repair of corneoscleral fistulas

Biostructurally Intact

KeraSys™ bioengineered lamellar patch graft consists of xenogeneic submucosa membrane that has been decellularized and processed to implantable device standards.

The material has been engineered to retain translucency and maximize strength and durability.

(Products may not be available in all markets.)

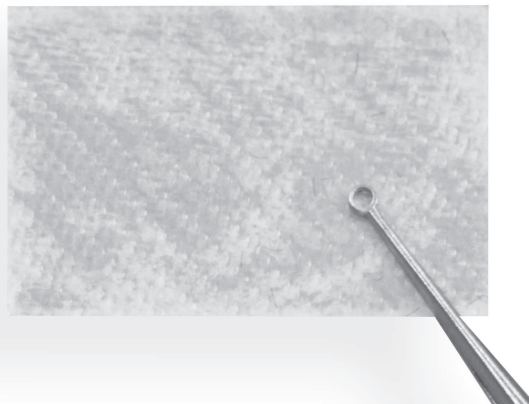

Catalog Number & Description

TK-41015 1 x 1.5 cm KeraSys™ Patch Graft

Lid Weights and Slings

SutureGroove™ Lid Weights

Gold eyelid weight implants

Lid weights feature recessed suture channels for comfort and improved cosmesis.

Conventional Uses

- Lagophthalmos
- Prevent corneal exposure

Catalog Number & Description

GOLD-06 0.6 gram Eyelid Weight Implant

GOLD-08 0.8 gram Eyelid Weight Implant

GOLD-10 1.0 gram Eyelid Weight Implant

GOLD-12 1.2 gram Eyelid Weight Implant

GOLD-14 1.4 gram Eyelid Weight Implant

GOLD-16 1.6 gram Eyelid Weight Implant

GOLD-18 1.8 gram Eyelid Weight Implant

GOLD-20 2.0 gram Eyelid Weight Implant

GOLD-22 2.2 gram Eyelid Weight Implant

BioElevation™

Tutoplast® Fascia Lata Slings

Immunologically safe, dehydrated human tissue allografts

5 year shelf life. Room temperature storage.

Conventional Use

- Eyelid ptosis surgery

(Products may not be available in all markets.)



SutureGroove™ Lid Weights

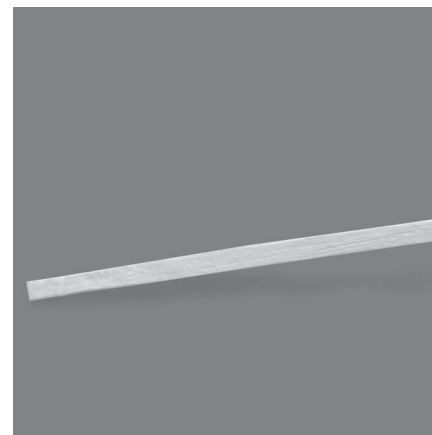

BioElevation™ Fascia Lata Sling

Catalog Number & Description

68021 2 x 14 cm Tutoplast® Fascia Lata

68022 0.2 x 20 cm Tutoplast® Fascia Lata

68027 0.2 x 18 cm Tutoplast® Fascia Lata

68028 0.3 x 12 cm Tutoplast® Fascia Lata

68029 0.3 x 15 cm Tutoplast® Fascia Lata

68030 0.3 x 18 cm Tutoplast® Fascia Lata

Tutoplast® is a registered trademark of RTI Biologics and is used with permission.

SutureGroove™ is a registered trademark of AMI and is used with permission.

Eyelid Spacer

tarSys™ Bioengineered Eyelid Spacer Graft

The tarSys™ bioengineered eyelid spacer graft is intended for implantation to reinforce and aid reconstruction of the eyelid. The tissue functions as the skeletal structure for the delicate mechanical properties of the lid and integrates with native tissue over time.

300 microns nominal thickness when hydrated (8 layer)

450 microns nominal thickness when hydrated (12 Layer)

18 month shelf life. Room temperature storage.



1 x 4 cm



Catalog Number & Description

TS-81040 1 x 4 cm (8 layer)

TS-121040 1 x 4 cm (12 layer)

Conventional Uses

- Engineered specifically for the repair of lid retraction.
- Biologic composition similar to tarsal plate.
- Compatible with superficial mucosa.
- Vertical support, no excess bulk.
- Integrates with host tissue.
- No graft site morbidity.

(Products may not be available in all markets.)

Orbital Implant Wraps and Socket Expanders

Tutoplast® Human Sclera

The patented Tutoplast® processed tissue technology has been partnered with whole human sclera to produce an optimal wrap for orbital implants.

5 year shelf life. Room temperature storage.

Catalog Number & Description

68332 Tutoplast® Whole Sclera

Osmed^{smh} Hydrogel Expander

The Osmed Tissue Expander consists of a Methylmethacrylate and N-Vinylpyrrolidone copolymer similar to what is used to manufacture soft contact lenses.

- Hemispheres for expansion of the socket and palpebral fissure.
- Spheres for expansion of the bony tissues of the deep orbit.

Product Code & Description

EXH-0611	0.4 ml Hemi-Socket
EXH-0814	0.9 ml Hemi-Socket
EXH-0814P	0.9 ml Hemi-Parallel
EXH-0918	1.5 ml Hemi-Socket
EXH-1020	2.0 ml Hemi-Socket
EXS-102	2.0 ml Orbit
EXS-103	3.0 ml Orbit
EXS-104	4.0 ml Orbit
EXS-105	5.0 ml Orbit

(Products may not be available in all markets.)

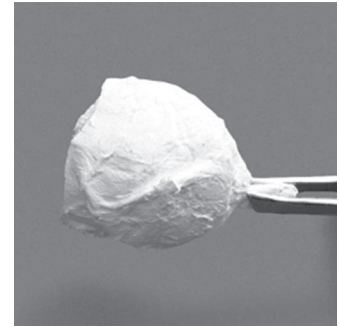

Tutoplast® is a registered trademark of RTI Biologics and is used with permission.

Suggested Instrument Sets - Table of Contents

Instrument Sets	Page Number
K10-2010 PLANNED EXTRA-CAPSULAR CATARACT EXTRACTION	212
K10-1011 FEMTO CATARACT SET	213
K10-1012 CHANG CONTINGENCY SET	214
K10-1013 IOL EXPLANTATION SET	215
K10-1014 MICRO IOL REMOVAL SET	216
K10-2015 EXTRA-CAPSULAR CATARACT EXTRACTION SET (PHACOEMULSIFICATION)	217
K10-2016 PHACO PRECHOP SET	218
K10-1017 MICRO INCISION CATARACT SURGERY (MICS) SET	219
K10-1020 MANUAL PHACOFRACTURE CATARACT EXTRACTION SET	220
K10-1021 MANUAL SMALL INCISION CATARACT SURGERY (MSICS) SET	221
K10-2022 LIMBAL RELAXING INCISION SET	222
K10-2023 TORIC IOL SET	223
K10-2025 GLAUCOMA SET	224
K10-2030 CORNEAL TRANSPLANT SET	225
K10-2032 DEEP ANTERIOR LAMELLAR KERATOPLASTY (DALK) SET	226
K10-2033 ENDOTHELIAL TRANSPLANTATION SET	227
K10-2035 LASIK SET	228
K10-2036 FEMTOSECOND LASIK SET	229
K10-1037 LASEK SET	230
K10-1040 LID SET	231
K10-1043 OCULOPLASTIC SET	232
K10-1045 CHALAZION SET	233
K10-2050 STRABISMUS SET	234
K10-1055 LACRIMAL SET	235
K10-1060 VITREORETINAL SET	236
K10-1065 ENUCLEATION SET	237
K10-1070 PTERYGIUM SET	238
K10-1080 OFFICE SET	239
K10-1090 VETERINARY OPHTHALMIC SET	240

Cataract Set

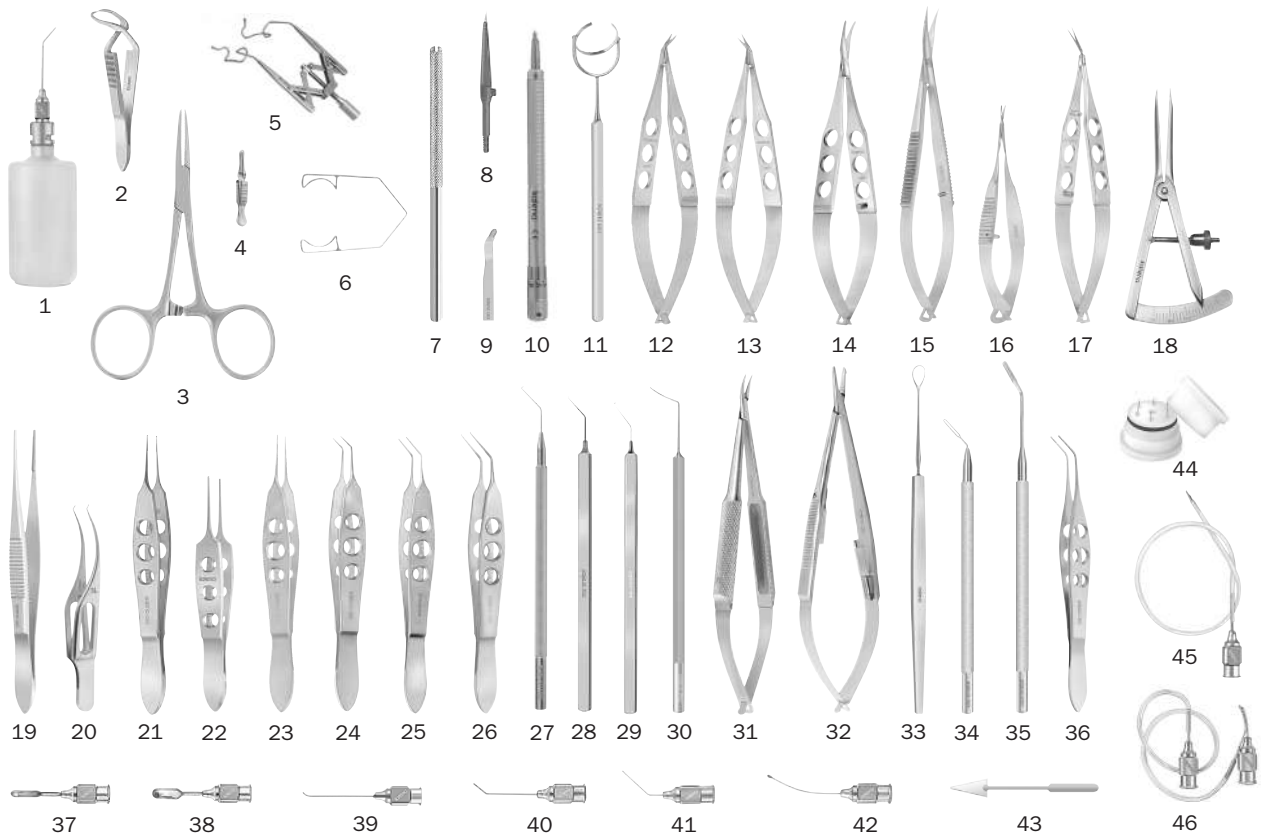

K10-2010 • PLANNED EXTRA-CAPSULAR CATARACT EXTRACTION

- | | | | |
|--------------------|--|---------------------|--|
| 1. K7-5000 | Bishop-Harmon A/C Irrigator | 25. K5-5030 | Kelman-McPherson Forceps |
| 2. K5-9960 | Jones Towel Clamp | 26. K5-5081 | Utrata Capsulorrhexis Forceps |
| 3. K5-9900 | Hartmann Mosquito Forceps, straight | 27. K3-2329 | Nagahara Phaco Chopper |
| 4. K5-9850 | Serrefine, small, straight | 28. K3-5230 | Sinskey II Lens Hook, angled |
| 5. K1-5691 | Double-X Speculum, K-wire, 15mm | 29. K3-5520 | Kuglen Iris Hook, angled |
| 6. K1-5010 | Barraquer Wire Speculum, large | 30. K3-2300 | Barraquer Iris Spatula |
| 7. K20-1910 | Chuck Handle (2) | 31. K6-3310 | Barraquer Needle Holder, curved |
| 8. K20-2442 | Super Sharp Blade, 15 deg. (bx) | 32. K6-1560 | Castroviejo Needle Holder, straight |
| 9. K20-2466 | Lamellar Blade #66 (bx) | 33. K3-4010 | Lewis Lens Loop |
| 10. K2-6540 | Diamond Step Knife | 34. K3-4145 | Alfonso Trisector, oval |
| 11. K3-6161 | Fine-Thornton Fixation Ring, 13mm | 35. K3-4156 | Alfonso Cutting Platform |
| 12. K4-1000 | Castroviejo Corneal Scissors, small, right | 36. K5-7253 | Alfonso Nucleus Forceps |
| 13. K4-1010 | Castroviejo Corneal Scissors, small, left | 37. K7-5532 | Alfonso-McIntyre Irrigating Spoon, small |
| 14. K4-3004 | Westcott Tenotomy Scissors | 38. K7-5533 | Alfonso-McIntyre Irrigating Spoon, large |
| 15. K4-4100 | Westcott Stitch Scissors | 39. K7-5241 | Anis Cortex Aspiration Cannula |
| 16. K4-5010 | Vannas Scissors, curved | 40. K7-3520 | Air Injection Cannula, 27ga. |
| 17. K4-5122 | Stern-Gills Scissors | 41. K7-5150 | McIntyre A/C Cannula, 26ga. |
| 18. K3-9000 | Castroviejo Caliper | 42. K7-4931 | Jensen Polisher, 23ga. |
| 19. K5-6200 | Bonaccolto Conjunctiva Forceps | 43. K20-5000 | K-Sponge Spears (bx) |
| 20. K5-1520 | Harms-Colibri Forceps, 0.12mm | 44. K3-4970 | Iris Retractors, (set of 6) in case |
| 21. K5-2020 | Bonn Forceps, 0.12mm | 45. K7-6715 | Brierley Chamber Maintainer |
| 22. K5-3510 | Bishop-Harmon Forceps | 46. K7-4300 | Simcoe I/A Cannula, curved |
| 23. K5-5000 | McPherson Tying Forceps, straight | 47. *K9-2350 | Sterilizing Case, double, aluminum |
| 24. K5-5010 | McPherson Tying Forceps, angled | | *not shown |

Femto Cataract Set

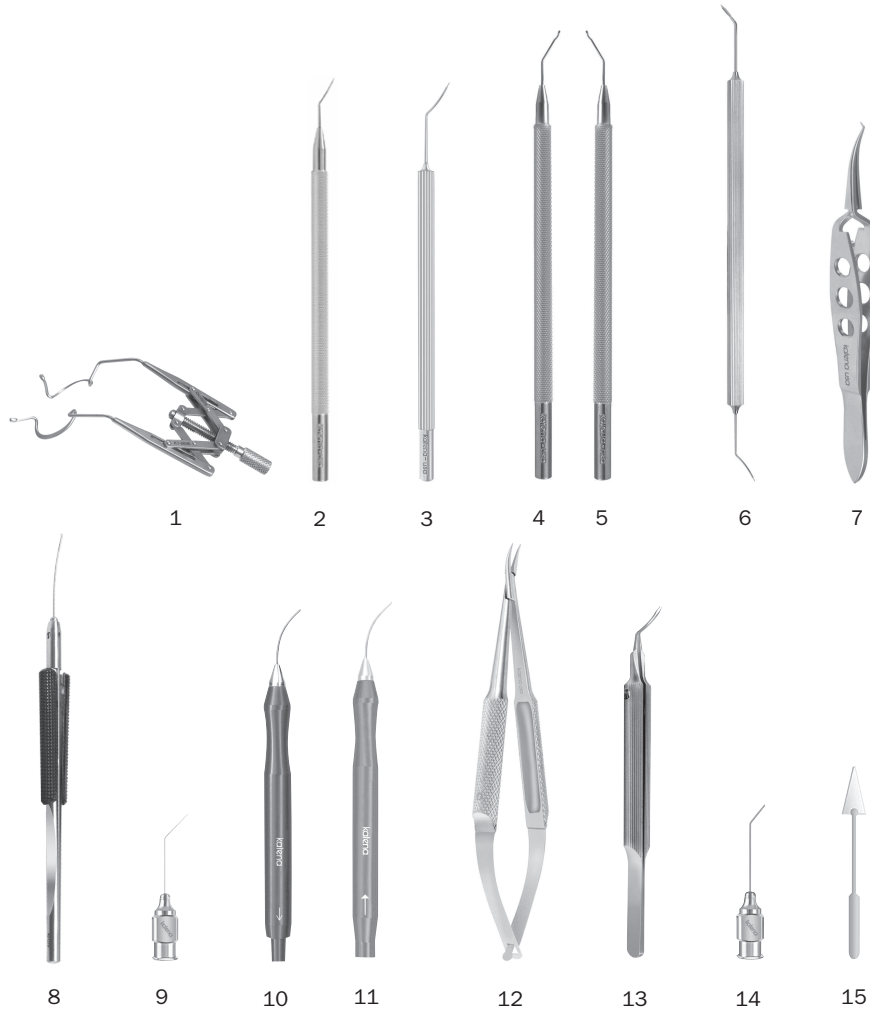

K10-1011 • FEMTO CATARACT SET

- | | |
|---|---|
| 1. K1-5697 Double-X Speculum, 13mm blades | 9. K7-5085 Chu Hydrodissection Cannula, 25ga. |
| 2. K3-2440 Donnerfeld Femto Spatula, spear tip | 10. K7-5811 Aspiration Handpiece, 21ga. with texture |
| 3. K3-2442 Katena Femto Spatula, blunt tip | 11. K7-5840 Irrigation Handpiece, 21ga. dual 0.5 ports |
| 4. K3-2450 Donnerfeld Femto Splitter, right | 12. K6-3310 Barraquer Needle Holder, curved |
| 5. K3-2451 Donnerfeld Femto Splitter, left | 13. K5-5090 Giannetti MICS Capsulorrhexis Forceps |
| 6. K3-2460 Katena Femto Spatula, D-E | 14. K7-3520 Air Injection Cannula, 27ga. |
| 7. K5-7245 Hu Femto Forceps | 15. K20-5000 K-Sponge Spears (bx) |
| 8. K5-7270 Femto Nucleus Forceps, 22ga. | 16. *K9-2340 Sterilizing Case, large, aluminum |

*not shown

Contingency Set

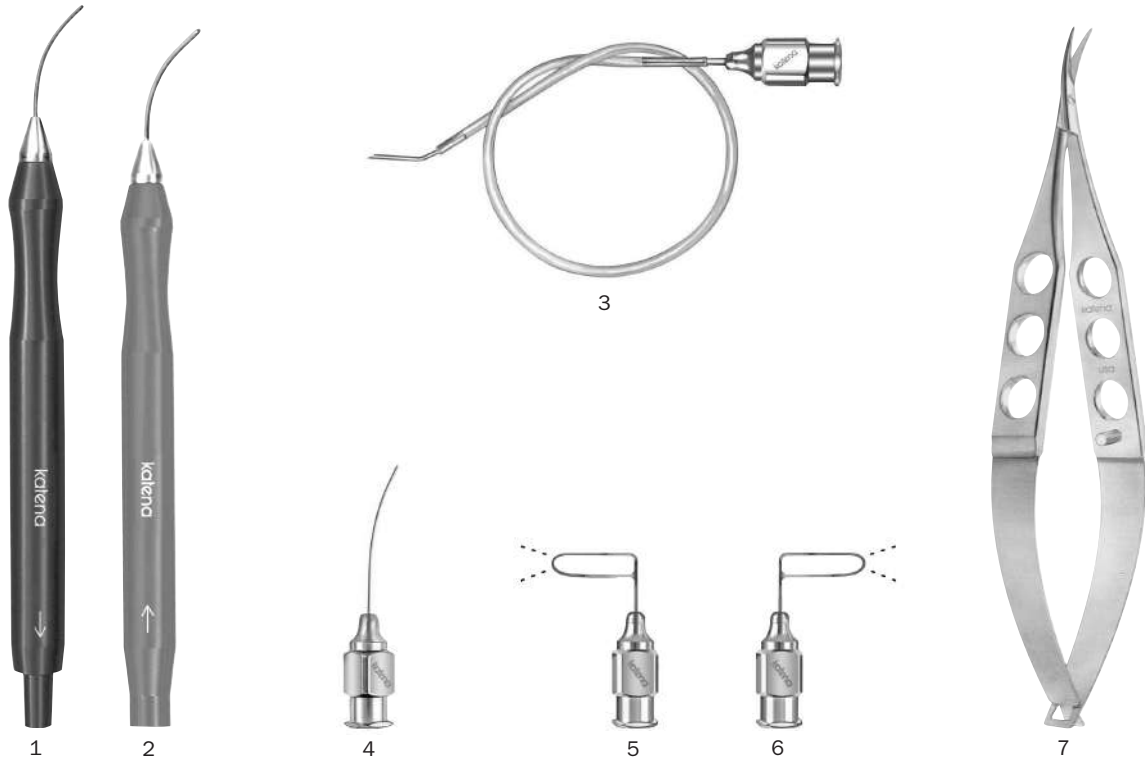

K10-1012 • CHANG CONTINGENCY SET

1. **K7-5811** Aspiration Handpiece, 21 gauge, 0.35mm port, textured tip
2. **K7-5840** Irrigation Handpiece, 21 gauge, dual 0.5mm ports
3. **K7-6711** Infusion Cannula, 22 gauge, self retaining tip, with tubing and adaptor
4. **K7-4008** Corbin Sub-Tenon's Cannula, 0.3 side port, 23 gauge
5. **K7-5530** Simcoe Irrigating Lens Loop, two front ports, 25 gauge, right
6. **K7-5531** Simcoe Irrigating Lens Loop, two front ports, 25 gauge, left
7. **K4-2220** Castroviejo Corneal Scissors, curved, blunt tips, medium blades
8. ***K9-2025** Sterilizing Case, medium, plastic

* not shown

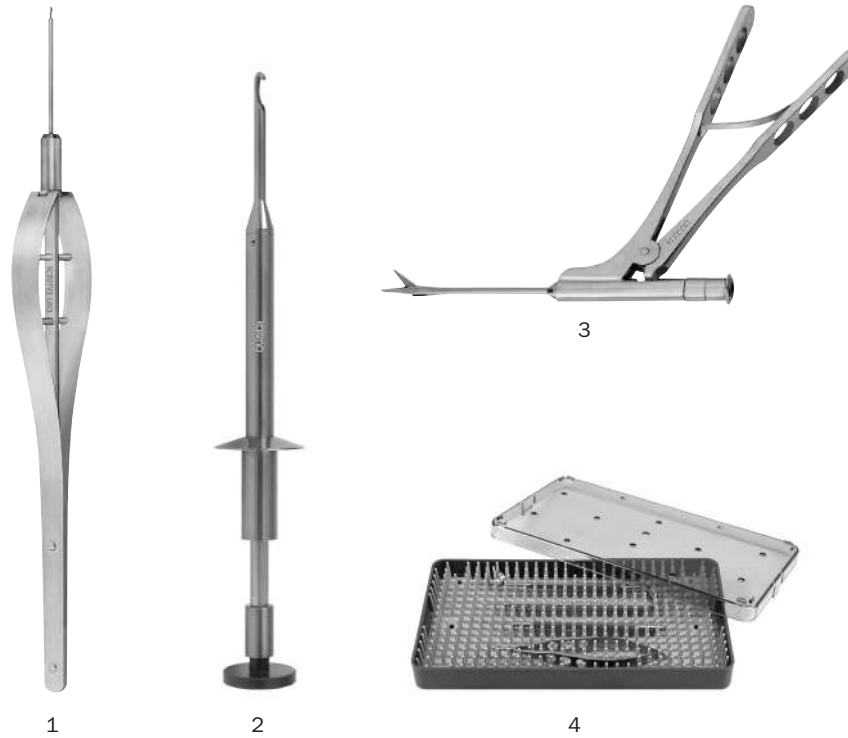

K10-1013 • IOL EXPLANTATION SET

1. **K4-5550** Scimeca Haptic Cutter
2. **K4-5565** Stolte IOL Cutter, titanium
3. **K4-5571** Katena IOL Cutter
4. **K9-2025** Sterilization Case, medium, plastic

Micro IOL Removal Set

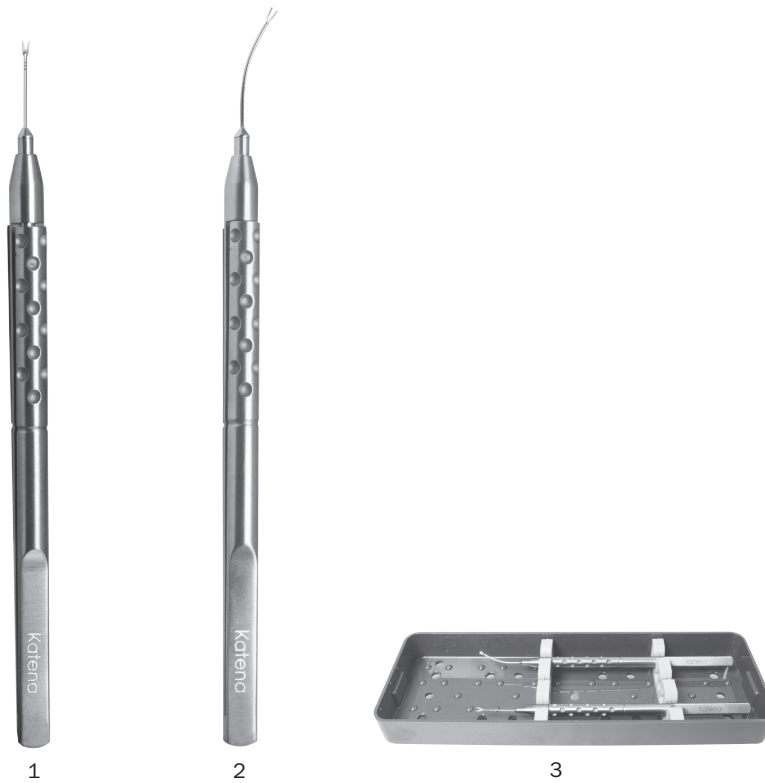

K10-1014 • DONNENFELD MICRO IOL REMOVAL SET

1. **K4-5560** Donnenfeld Micro Soft IOL Cutter
2. **K5-7570** Donnenfeld Micro IOL Holding Forceps
3. **K9-2024** Sterilizing Case, plastic, 3-instruments

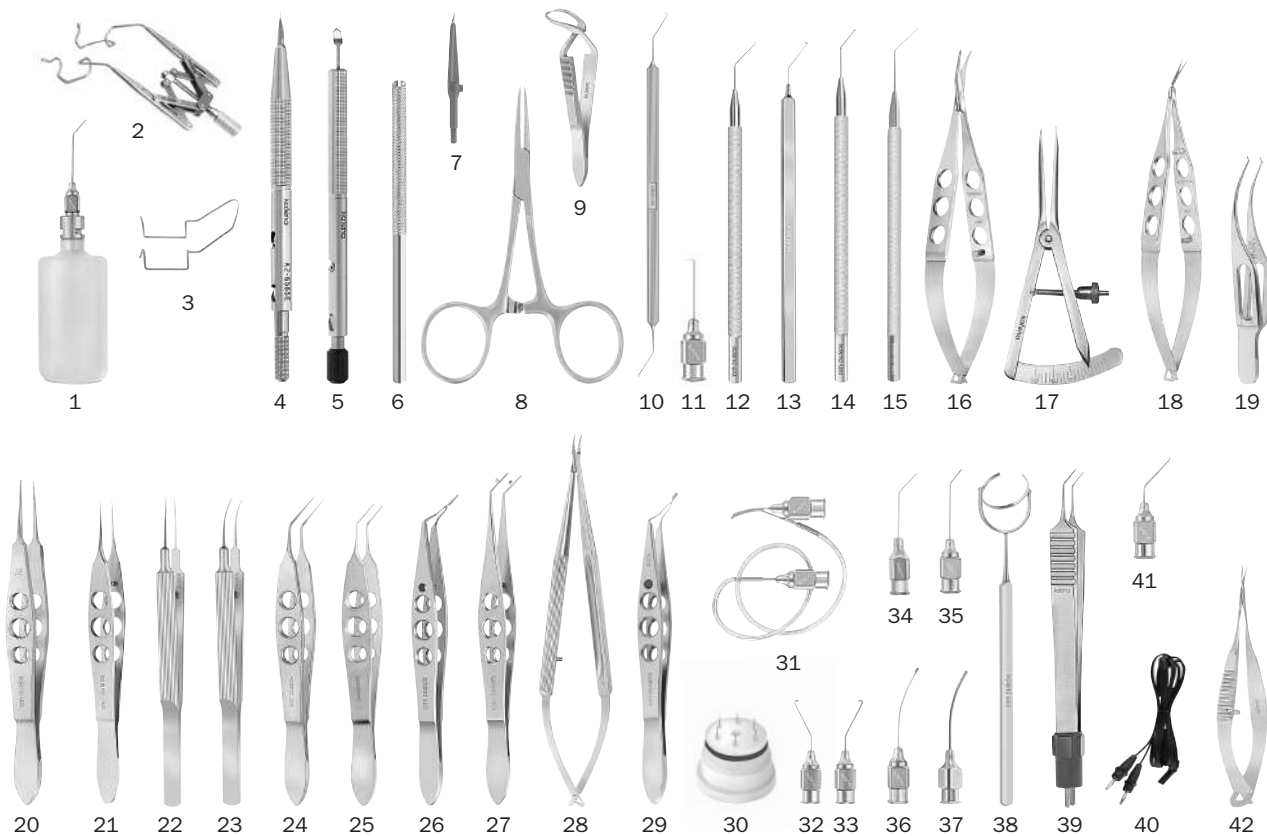

K10-2015 • EXTRA-CAPSULAR CATARACT EXTRACTION USING PHACOEMULSIFICATION SET

- | | | | |
|--------------------|--------------------------------------|----------------------|--------------------------------------|
| 1. K7-5000 | Bishop-Harmon A/C Irrigator | 23. K5-5230 | Tennant Tying Forceps, curved |
| 2. K1-5695 | Double-X Speculum, V-Wire, 15mm | 24. K5-5081 | Utrata Capsulorrhexis Forceps |
| 3. K1-5015 | Temporal Speculum, open wire | 25. K5-5030 | Kelman-McPherson Forceps, angled |
| 4. K2-6565 | Diamond Knife, tri-facet | 26. K5-8228 | Ernest-McDonald IOL Inserter |
| 5. K2-6605 | Phaco-4 Diamond Knife, 2.8mm, angled | 27. K5-8215 | Livernois IOL Folder |
| 6. K20-1910 | Chuck Handle | 28. K6-3820 | Katena Needle Holder, curved, w/lock |
| 7. K20-2442 | Super Sharp Blade, 15 deg. (bx) | 29. K5-7240 | Ernest Nucleus Cracker |
| 8. K5-9900 | Hartmann Mosquito Forceps, str. | 30. K3-4970 | Iris Retractors, (set 6) in case |
| 9. K5-9960 | Jones Towel Clamp | 31. K7-4300 | Simcoe I/A Cannula, curved |
| 10. K3-2369 | Chang Combination Chopper, left | 32. K7-5440 | McIntyre-Binkhorst Cannula, right |
| 11. K7-5464 | Chang Hydrodissection Cannula, 27ga. | 33. K7-5450 | McIntyre-Binkhorst Cannula, left |
| 12. K3-2395 | Rosen Phaco Splitter | 34. K7-5054 | Hydrodissection Cannula, 25ga. |
| 13. K3-5520 | Kuglen Iris Hook, angled | 35. K7-3520 | Air Injection Cannula, 27ga. |
| 14. K3-2410 | Jaffe-Bechert Rotator, 9mm | 36. K7-4931 | Jensen Polisher, 23ga. |
| 15. K3-2690 | Lester IOL Manipulator, angled | 37. K7-4005 | Stevens Sub-Tenon's Cannula, 19ga. |
| 16. K4-3004 | Westcott Tenotomy Scissors | 38. K3-6161 | Fine-Thornton Fixation Ring, 13mm |
| 17. K3-9000 | Castroviejo Caliper, straight | 39. K8-7021 | Bipolar Forceps, angled, blunt |
| 18. K4-5122 | Stern-Gills Scissors | 40. K8-7065 | Bipolar Cord |
| 19. K5-1500 | Colibri Forceps, 0.12mm teeth | 41. K7-4680 | McIntyre Reverse Cystotome |
| 20. K5-2500 | Castroviejo Forceps, 0.12mm | 42. K4-5010 | Vannas Scissors, curved |
| 21. K5-1820 | Fechtner Conjunctiva Forceps | 43. *K20-5000 | K-Sponge Spears |
| 22. K5-5220 | Tennant Tying Forceps, straight | 44. *K9-2350 | Sterilizing Case, double, aluminum |

*not shown

Phaco Prechop Set

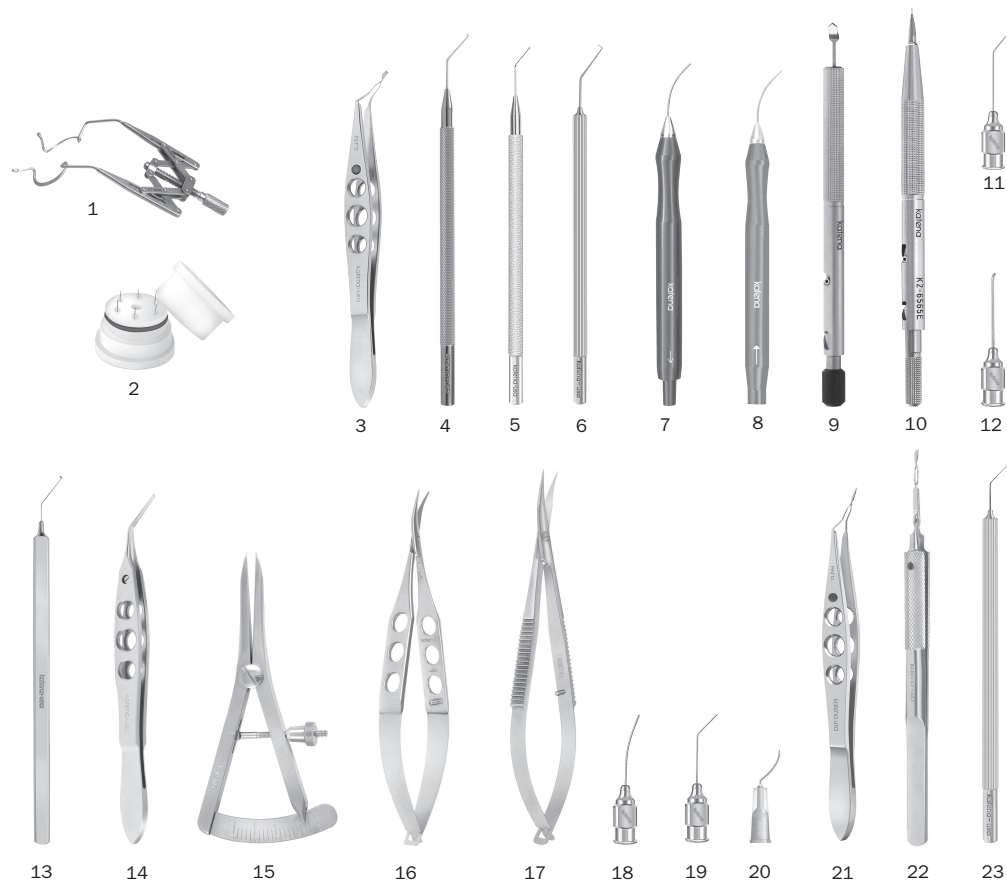

K10-2016 • PHACO PRECHOP SET

- | | |
|--|--|
| 1. K1-5697 Double-X Speculum, 13mm blades | 13. K3-5520 Kuglen Hook, angled |
| 2. K3-4970 Iris Retractors (set 6) in case | 14. K5-5091 Utrata MICS Capsulorrhexis Forceps |
| 3. K5-7242 Ernest Micro Nucleus Cracker | 15. K3-9000 Castroviejo Caliper, straight |
| 4. K3-5233 Sinsky II Lens Manipulator | 16. K4-3004 Westcott Tenotomy Scissors |
| 5. K3-2410 Jaffe-Bechert Nucleus Rotator | 17. K4-4100 Westcott Stitch Scissors |
| 6. K3-2383 Dodick-Kammann Chopper 1.5mm, angled (x2) | 18. K7-5082 Sauter Hydrodissection Cannula, 27ga. |
| 7. K7-5811 Aspiration Handpiece, 21ga. w/ textured tip | 19. K7-5054 Hydrodissection Cannula, 25ga. |
| 8. K7-5840 Irrigation Handpiece, 21ga. dual 0.5mm sideports | 20. K20-3066 Cystotome, formed, 25ga. (bx/10) |
| 9. K2-6605 Phaco-4 Diamond Knife, 2.8mm, angled | 21. K5-7230 Akahoshi Phaco PreChopper |
| 10. K2-6565 Diamond Knife, tri-facet, 1mm | 22. K5-7232 Akahoshi Combo PreChopper |
| 11. K7-3500 Air Injection Cannula, 30ga. | 23. K3-2357 Akahoshi Nucleus Sustainer |
| 12. K7-4900 Kratz Scratcher, 22ga. | 24. *K9-2340 Instrument Case, large, aluminum |

* not shown

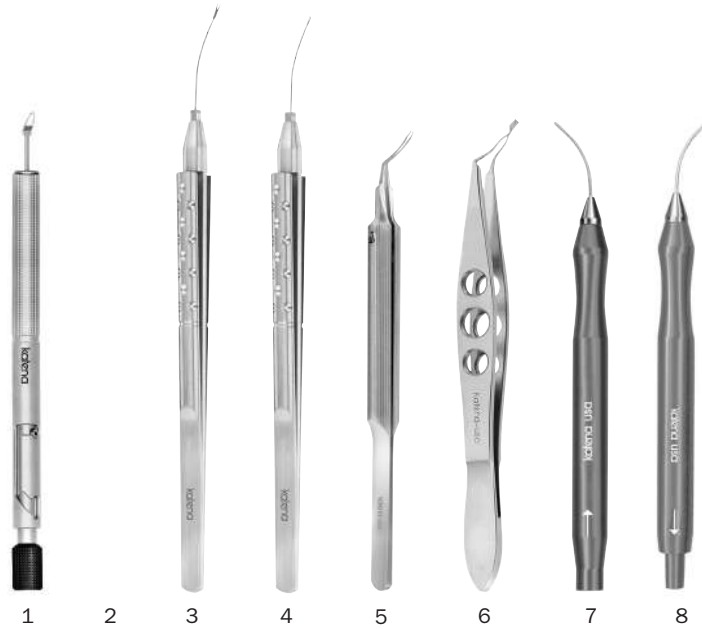

K10-1017 • MICRO INCISION CATARACT SURGERY (MICS) SET

1. **K2-6622** MICS Diamond Knife Trapezoid, 1.8/2.2mm
2. **K3-2697** Alio-Kelman IOL Hook
3. **K4-5351** Alio MICS Scissors, 23ga.
4. **K5-7651** Alio MICS Capsulorrhexis Forceps, 23ga.
5. **K5-5090** Giannetti MICS Capsulorrhexis Forceps
6. **K5-7242** Ernest Micro Nucleus Cracker
7. **K7-5836** Irrigating Handpiece, 23ga., dual 0.3mm ports
8. **K7-5805** Aspirating Handpiece, 0.3mm, with textured tip
9. ***K9-2330** Instrument Case, medium, aluminum
* not shown

PhacoFracture Cataract Set



K10-1020 • MANUAL PHACOFRACTURE CATARACT EXTRACTION SET

as used by Eduardo Alfonso, M.D.

- | | | | |
|--------------------|-------------------------------------|---------------------|--|
| 1. K1-5675 | Lieberman Speculum, V-wire | 15. K3-4146 | Bucher-Kansas Nucleus Trisector |
| 2. K4-7400 | Eye Scissors, straight | 16. K3-4150 | Kansas Nucleus Bisector |
| 3. K4-3004 | Westcott Tenotomy Scissors | 17. K5-7253 | Alfonso Nucleus Forceps, 3x4 teeth |
| 4. K5-2500 | Castroviejo Forceps, 0.12mm | 18. K7-5532 | Alfonso-McIntyre Irrigating Spoon, small |
| 5. K20-1910 | Chuck Handle (3) | 19. K7-5533 | Alfonso-McIntyre Irrigating Spoon, large |
| 6. K20-2466 | Performance Lamellar Blade #66 (bx) | 20. K7-6750 | McIntyre Infusion Handle |
| 7. K20-2442 | Performance Super Sharp Blade (bx) | 21. K7-3522 | Air Injection Cannula, 27ga. |
| 8. K20-2476 | Performance Phaco Blade (bx) | 22. K7-5240 | Anis Cortex Aspirating Cannula, straight |
| 9. K3-9000 | Castroviejo Caliper, straight | 23. K7-6715 | Brierley Chamber Maintainer |
| 10. K5-5081 | Utrata Capsulorrhexis Forceps | 24. K8-7012 | Bipolar Forceps, straight, pointed |
| 11. K3-5523 | Kuglen Lens Manipulator, angled | 25. K5-8210 | Dodick IOL Folding Forceps |
| 12. K3-4156 | Alfonso Cutting Platform, 2mm | 26. K5-8268 | Buratto Soft IOL Inserter |
| 13. K3-4157 | Alfonso Cutting Platform, 3mm | 27. *K7-6748 | Silicone Tubing w/adaptor for K7-6750 |
| 14. K3-4145 | Alfonso Nucleus Trisector, oval | 28. *K9-2040 | Sterilizing Case, double, plastic |

* not shown

Technique Video Available

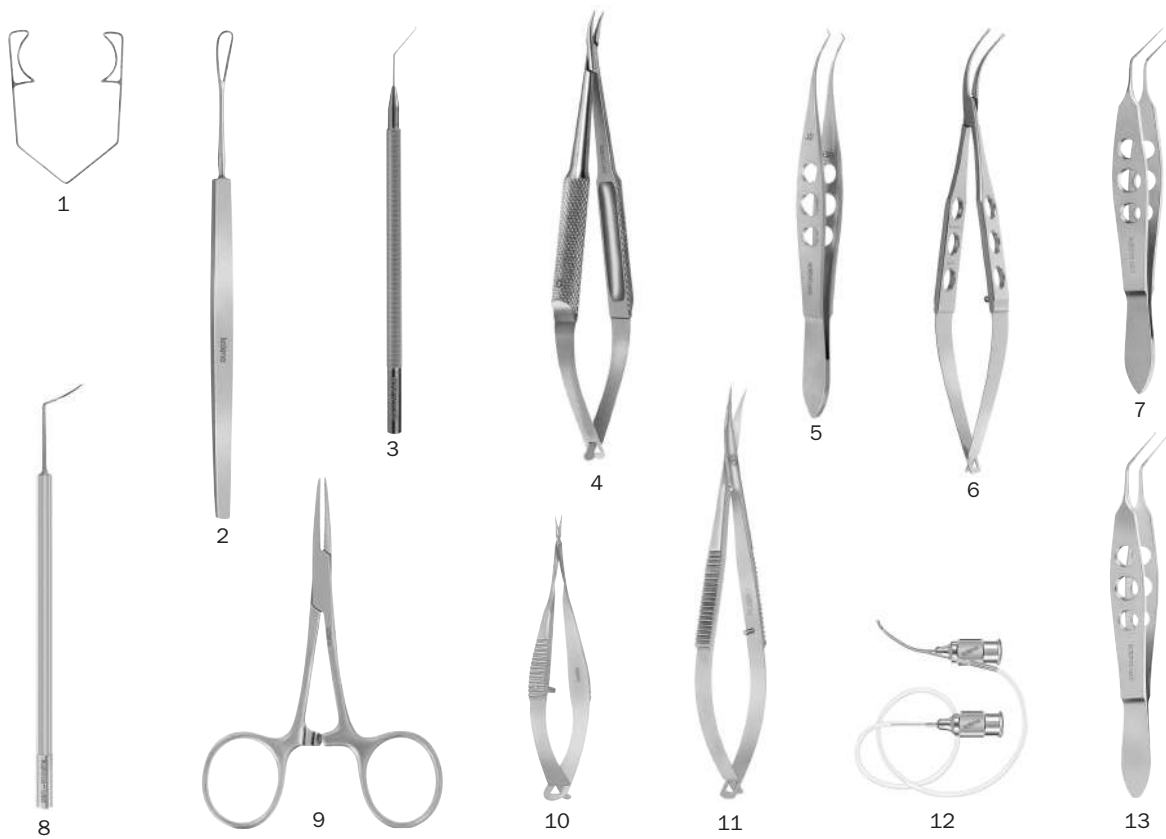

K10-1021 • MANUAL SMALL INCISION CATARACT SURGERY (MSICS) SET
as used by Glenn Strauss, M.D.

- | | |
|--|--|
| 1. K1-5010 Barraquer Wire Speculum, large | 8. K3-2300 Barraquer Iris Spatula, 0.5mm |
| 2. K3-4100 Wilder Lens Loop, serrated | 9. K5-9900 Hartmann Mosquito Forceps, straight |
| 3. K3-5233 Sinsky II Lens Hook, angled | 10. K4-5000 Vannas Scissors, straight |
| 4. KT6-3310 Barraquer Needle Holder, curved, titanium | 11. K4-4100 Westcott Stitch Scissors |
| 5. K5-1902 Harms-Colibri Forceps, 0.12mm curved | 12. K7-4320 Strauss-Simcoe I/A Cannula |
| 6. K5-8600 Shepard Lens Forceps | 13. K5-5081 Utrata Capsulorrhexis Forceps |
| 7. K5-5050 Gaskin Fragment Forceps, angled | 14. *K9-2330 Sterilizing Case, medium, aluminum |
- * not shown



K10-2022 • LIMBAL RELAXING INCISION SET

1. **K2-6519** LRI Step Knife, 3 Steps (0.5, 0.55, 0.6mm)
2. **K5-7245** Hu Femto Forceps
3. **K3-7908** Henderson Alignment Marker
4. **K3-7906** Alignment Marker with Bubble
5. **K3-7904** Henderson Degree Gauge
6. **K3-7936** Henderson Limbal Relaxing Incision Marker
7. **K3-7930** Chu Limbal Relaxing Incision Marker
8. **K20-4500** Marking Pen, sterile, disposable (pk/10)
9. ***K9-2320** Instrument Case, small, aluminum

* not shown

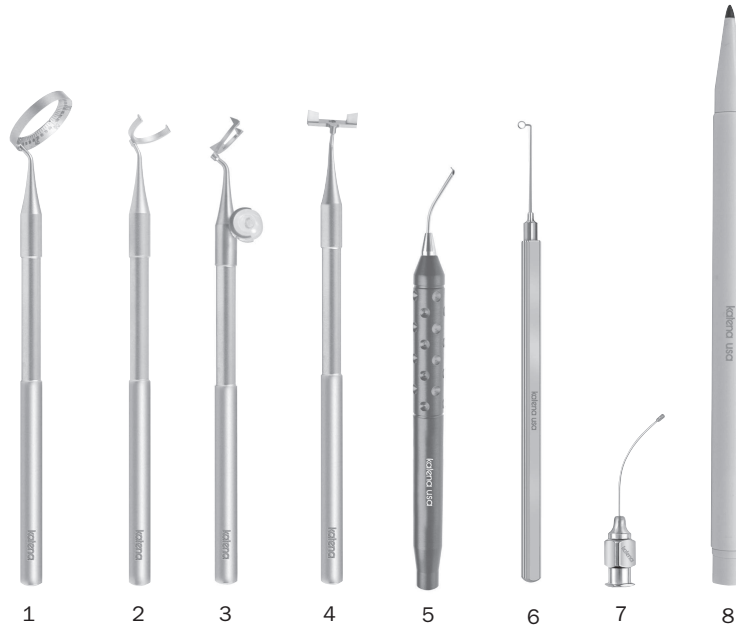

K10-2023 • TORIC IOL SET

1. **K3-7904** Henderson Degree Gauge
 2. **K3-7908** Henderson Alignment Marker
 3. **K3-7906** Alignment Marker with Bubble
 4. **K3-7912** Henderson Toric IOL Marker
 5. **K7-5780** Lu Irrigating Toric Lens Manipulator
 6. **K3-1105** Scorsetti-Shepherd Capsule Polisher, 90°
 7. **K7-4890** Henderson MICS Capsule Polisher
 8. **K20-4500** Marking Pen, sterile, disposable (pk/10)
 9. ***K9-2025** Sterilizing Case, medium, plastic
- * not shown

Glaucoma Set

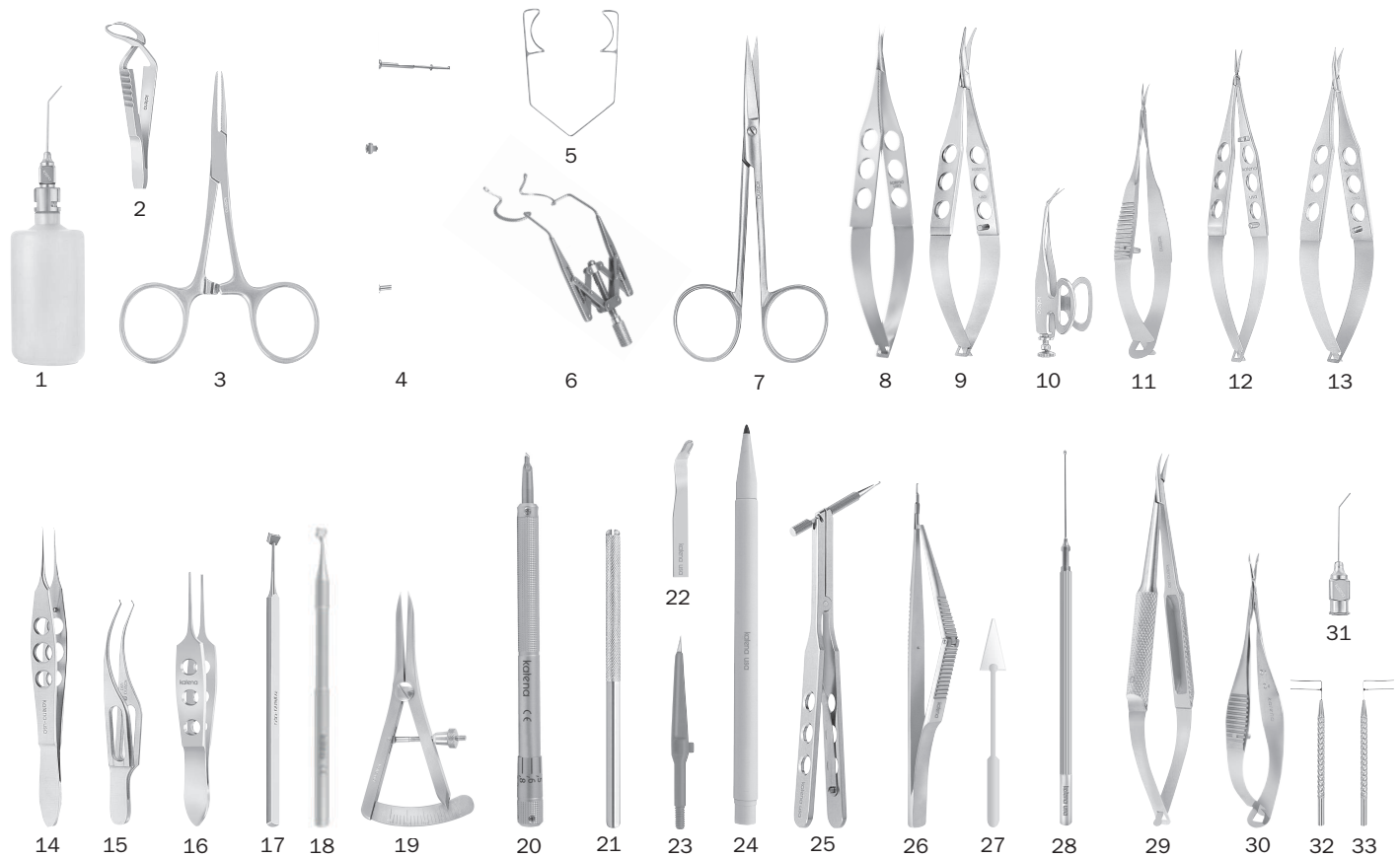

K10-2025 • GLAUCOMA SET

- | | | | | | |
|-----|----------------|---|-----|-----------------|--|
| 1. | K7-5000 | Bishop-Harmon A/C Irrigator | 18. | K3-8977 | Fechtner EX-PRESS® Marker |
| 2. | K5-9960 | Jones Towel Clamp | 19. | K3-9000 | Castroviejo Caliper, straight |
| 3. | K5-9900 | Hartmann Mosquito Forceps, straight | 20. | K2-6548 | Diamond Step Knife, 10-facet |
| 4. | K1-5955 | Schott Eye Speculum, adjustable | 21. | K20-1910 | Chuck Handle (2) |
| 5. | K1-5010 | Barraquer Wire Speculum, large | 22. | K20-2466 | Lamellar Blade #66 (bx) |
| 6. | K1-5697 | Double-X Speculum, 13mm blades | 23. | K20-2442 | Super Sharp Blade, 15 deg. (bx) |
| 7. | K4-7400 | Eye Scissors, straight | 24. | K20-4500 | Marking Pen, sterile, disposable (pk/10) |
| 8. | K4-3002 | Sarkisian-Westcott Scissors, small blades | 25. | K2-9505 | Luntz-Dodick Trabeculectomy Punch |
| 9. | K4-3004 | Westcott Tenotomy Scissors | 26. | K2-9510 | Kelly Descemet's Membrane Punch |
| 10. | K4-4900 | Barraquer Iris Scissors | 27. | K20-5000 | K-Sponge Spears |
| 11. | K4-3200 | Mini Westcott Scissors | 28. | K3-1124 | Blumenthal Conjunctiva Dissector |
| 12. | K4-5111 | Katena-Vannas Scissors, 7mm, curved | 29. | K6-3310 | Barraquer Needle Holder, curved |
| 13. | K4-4000 | McPherson-Westcott Stitch Scissors | 30. | K4-4200 | Katena Micro Tying Scissors |
| 14. | K5-1820 | Fechtner Conjunctiva Forceps (2) | 31. | K7-3520 | Air Injection Cannula, 27ga. |
| 15. | K5-1500 | Colibri Forceps, 0.12mm teeth | 32. | K7-1000 | Harms Trabeculotomy Probe, right |
| 16. | K5-3510 | Bishop-Harmon Forceps | 33. | K7-1010 | Harms Trabeculotomy Probe, left |
| 17. | K3-8975 | Fechtner Trabeculectomy Marker | 34. | *K9-2350 | Sterilizing Case, double, aluminum |

* not shown

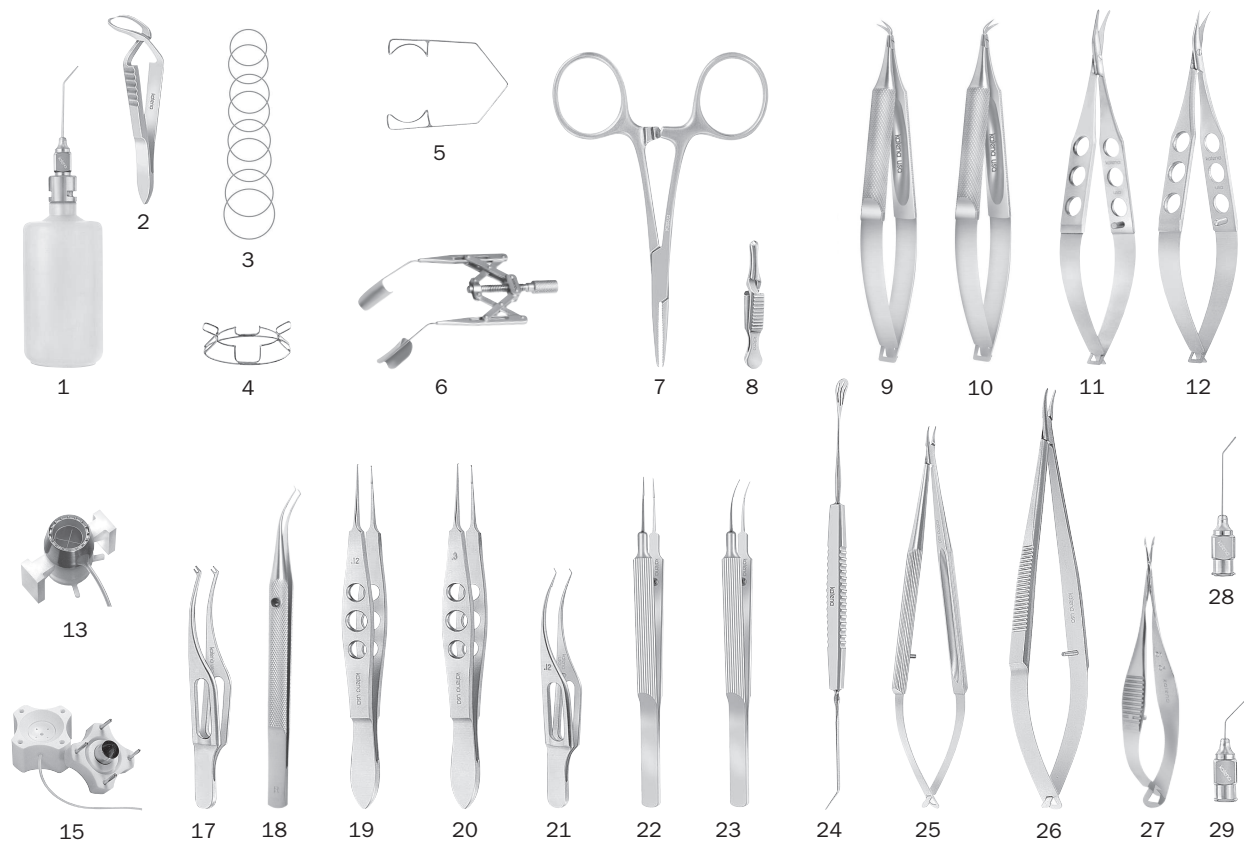

K10-2030 • CORNEAL TRANSPLANT SET

- | | | | |
|----------------------|---|----------------------|--|
| 1. K7-5000 | Bishop-Harmon A/C Irrigator | 17. K5-1560 | Polack Double Corneal Fixation Forceps |
| 2. K5-9960 | Jones Towel Clamp | 18. K5-2914 | Perl Corneal Forceps, 0.08mm, left |
| 3. K1-7100 | Flieringa Rings (set of 8) | 19. K5-2500 | Castroviejo Forceps, 0.12mm |
| 4. K1-7312 | McNeill-Goldman Fixation Ring | 20. K5-2510 | Castroviejo Forceps, 0.3mm |
| 5. K1-5010 | Barraquer Wire Speculum, large | 21. K5-1520 | Harms-Colibri Forceps, 0.12mm |
| 6. K1-5698 | Double-X Speculum, solid blade 15mm | 22. K5-5220 | Tennant Tying Forceps, straight |
| 7. K5-9900 | Hartmann Mosquito Forceps, straight (2) | 23. K5-5230 | Tennant Tying Forceps, curved |
| 8. K5-9850 | Serrefine, small, straight (2) | 24. K3-4255 | Paton Spatula & Spoon |
| 9. K4-2017 | Terry Micro Corneal Scissors, left | 25. K6-3820 | Katena Needle Holder, curved w/lock |
| 10. K4-2016 | Terry Micro Corneal Scissors, right | 26. K6-1520 | Castroviejo Needle Holder, curved w/lock |
| 11. K4-3004 | Westcott Tenotomy Scissors | 27. K4-4200 | Katena Micro Tying Scissors |
| 12. K4-4150 | Jaffe Stitch Scissors | 28. K7-3500 | Air Injection Cannula, 30ga. |
| 13. K20-2056 | Barron Vacuum Trepphine, 7.5mm | 29. K7-5150 | McIntyre A/C Cannula, 26ga. |
| 14. *K20-2058 | Barron Vacuum Trepphine, 8.0mm | 30. *K9-2350 | Sterilizing Case, double, aluminum |
| 15. K20-2108 | Barron Vacuum Punch, 8.0mm | 31. *K20-5010 | K-Sponge II spears, synthetic (bx) |
| 16. *K20-2110 | Barron Vacuum Punch, 8.5mm | | |

*not shown

DALK Set

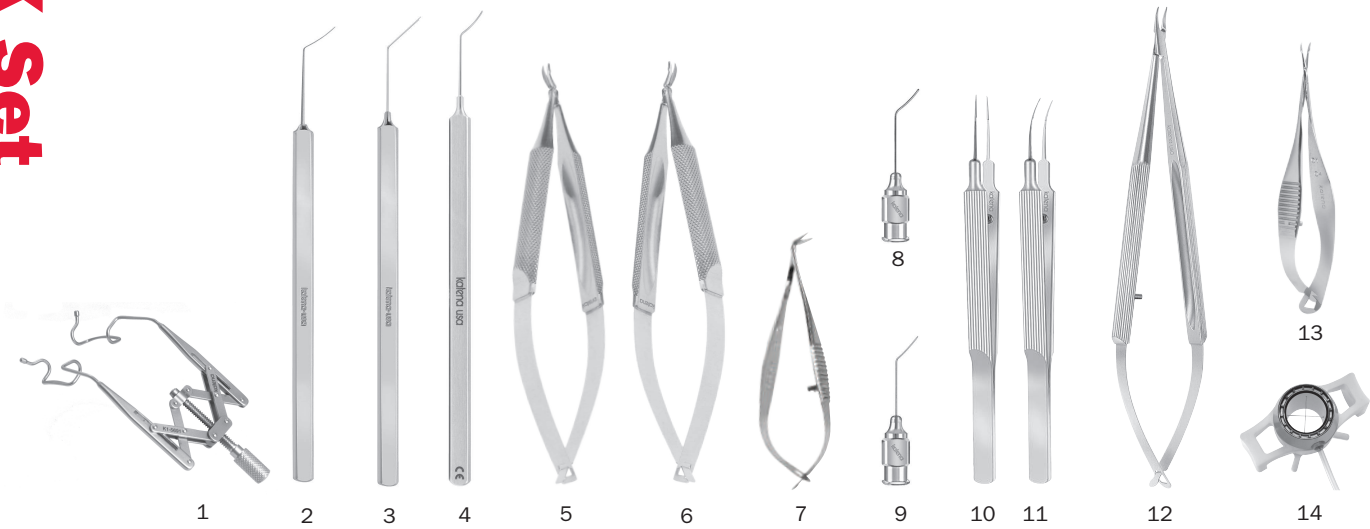

K10-2032 • DEEP ANTERIOR LAMELLAR KERATOPLASTY (DALK) SET

1. **K1-5691** Double-X Speculum, K-Wire, 15mm blades
2. **K3-1870** DALK Corneal Dissector
3. **K3-1875** Rosenwasser DALK Trisector
4. **K3-1877** Bonfadini DALK Spatula
5. **K4-2019** Holland DALK Scissors, left
6. **K4-2018** Holland DALK Scissors, right
7. **K4-5075** Holland DALK Scissors, angled, blunt
8. **K7-3590** DALK Air Injection Cannula, 27ga.
9. **K7-3595** Rosenwasser DALK Cannula, 27ga.
10. **K5-5220** Tennant Tying Forceceps, delicate, straight
11. **K5-5230** Tennant Tying Forceceps, delicate, curved
12. **K6-3830** Katena Needle Holder, extra-delicate, curved
13. **K4-4200** Katena Micro Tying Scissors
14. **K20-2058** Barron Radial Vacuum Trepine, 8.0mm
- 15.***K9-2330** Sterilizing Case, medium, aluminum

*not shown

Endothelial Transplant Set

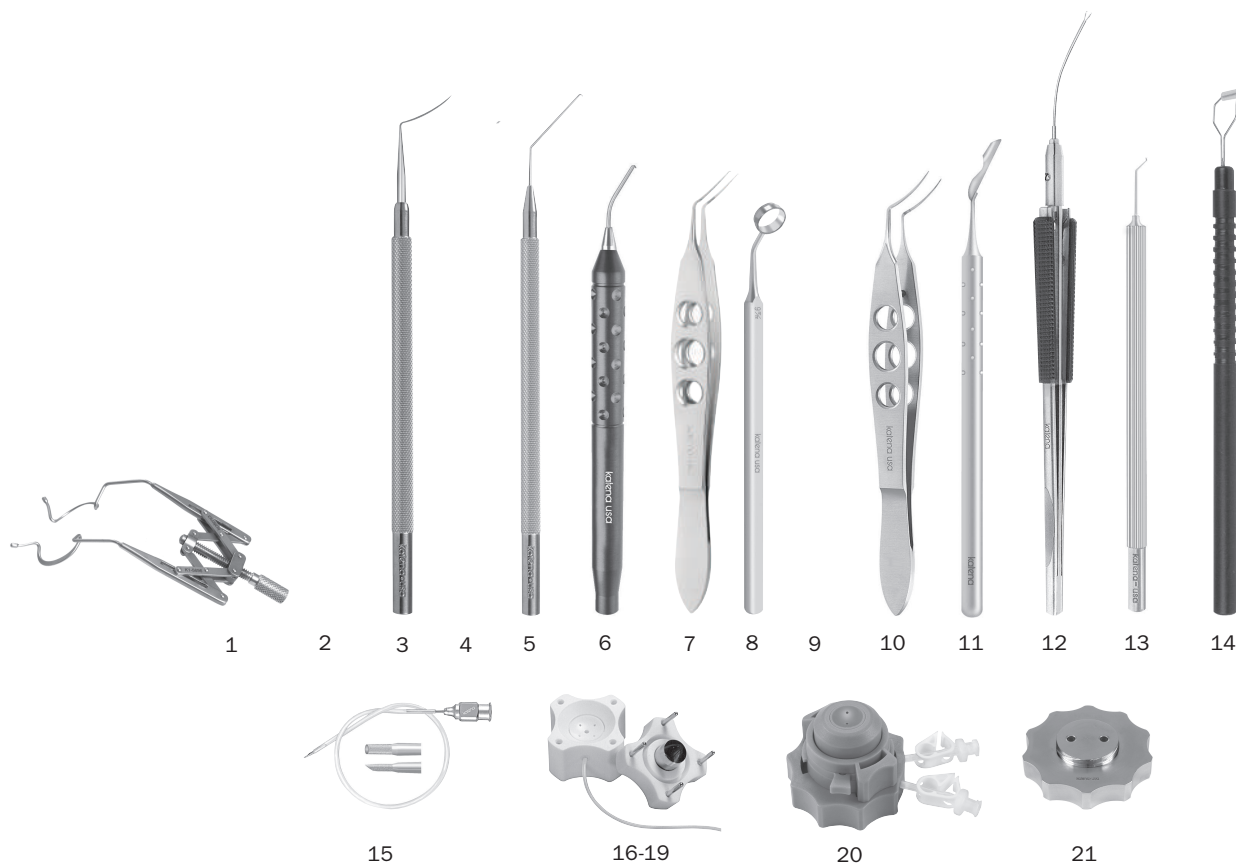

K10-2033 • ENDOTHELIAL TRANSPLANTATION SET

- | | |
|--|---|
| 1. K1-5697 Double-X Speculum, 13mm blades | 12. K5-7550 DSEK Grasping Forceps, 23ga. |
| 2. K2-3660 Corneal Dissector, straight | 13. K3-1880 Rootman-Goldich DMEK Dissector |
| 3. K2-3661 Corneal Dissector, vaulted | 14. K20-3845 Rubenstein Corneal Roller, sterile (pk/3) |
| 4. K3-5002 Reversed Sinskey Hook | 15. K7-6717 Dahan-Blumenthal A/C Maintainer |
| 5. K3-1830 Endothelial Stripper | 16. K20-2110 Barron Vacuum Punch, 8.5mm |
| 6. K7-5897 Rosenwasser Irrigating Endothelial Stripper | 17. * K20-2111 Barron Vacuum Punch, 8.75mm |
| 7. K5-5095 Florakis Endothelial Forceps | 18. * K20-2112 Barron Vacuum Punch, 9.0mm |
| 8. K3-8154 Bore's Optic Zone Marker, 9.0mm | 19. * K20-2114 Barron Vacuum Punch, 9.5mm |
| 9. K3-4263 Rosenwasser Donor Lamellar Inserting Shovel | 20. K20-2125 Barron Artificial Anterior Chamber |
| 10. K5-8010 Rosenwasser Donor Lamella Inserting Forceps | 21. K20-2126 Barron Stainless Steel Base |
| 11. K3-4270 Endothelial Glide Spatula | 22. * K9-2340 Instrument Case, large, aluminum
*not shown |

LASIK Set

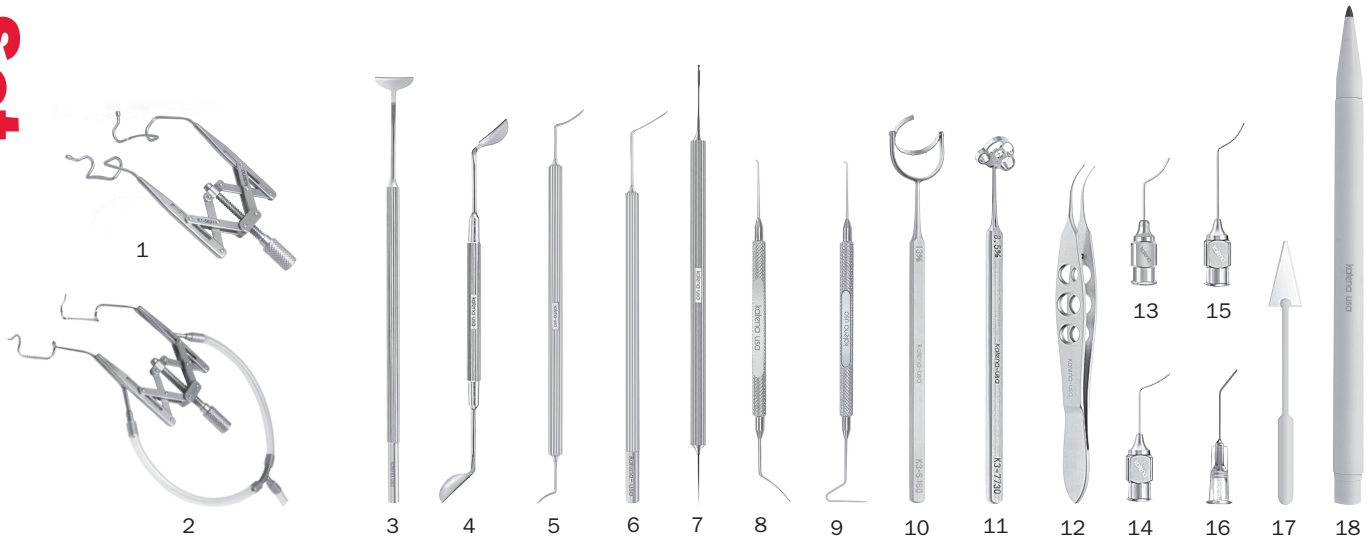

K10-2035 • LASIK SET

- | | | | |
|--------------------|---|---------------------|--|
| 1. K1-5691 | Double-X Speculum, K-Wire, 15mm blades | 11. K3-7730 | Chayet Corneal Marker |
| 2. K1-5191 | Double-X Aspirating Speculum (optional) | 12. K5-5058 | Buratto LASIK Flap Forceps |
| 3. K3-1770 | Buratto Flap Protector | 13. K7-5112 | Banaji LASIK Cannula, 26ga. |
| 4. K3-1773 | Mannis-Buratto Flap Protector | 14. K7-5106 | Spatulated LASIK Cannula, 26ga. |
| 5. K3-2526 | Hersh LASIK Spatula | 15. K7-5118 | Buratto LASIK Cannula, 3-ports, 23ga. |
| 6. K3-2530 | Fukasaku LASIK Spatula | 16. K20-3151 | John IntraLasik Cannula, sterile (pk/10) |
| 7. K3-2534 | Katzen LASIK Flap Unzipper | 17. K20-5010 | K-Sponge II spears, synthetic (bx) |
| 8. K3-2537 | Thorlakson Z-LASIK™ Flap Lifter | 18. K20-4500 | Marking Pen, standard (pk/10) |
| 9. K3-2538 | IntraLase® Flap Lifter, D-E | 19. *K9-2340 | Instrument Case, large, aluminum |
| 10. K3-6160 | Gimbel Stabilization Ring | | *not shown |

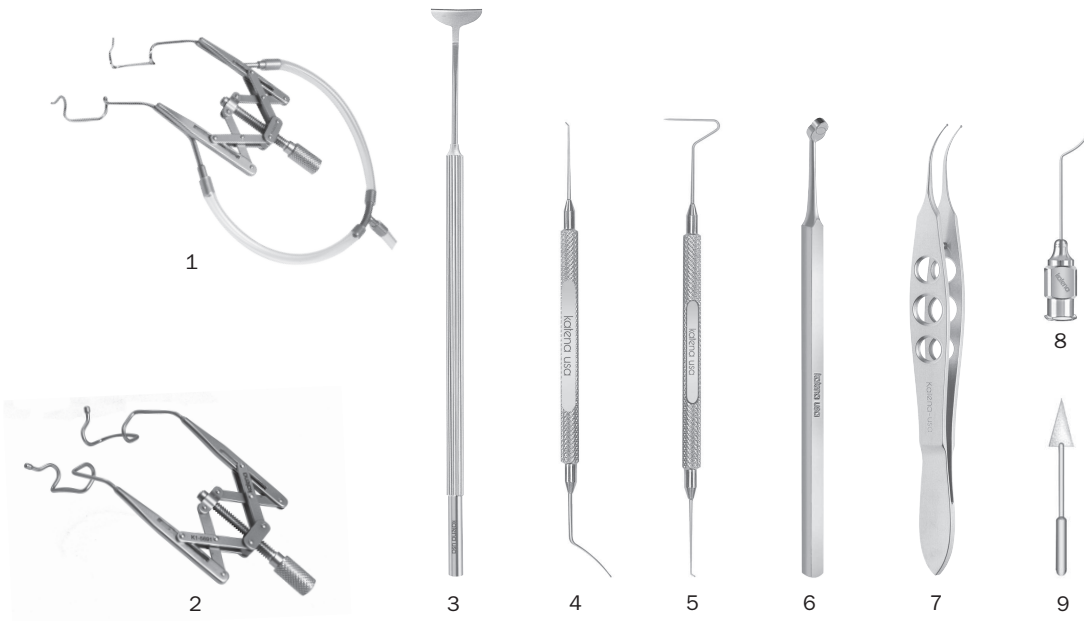

K10-2036 • FEMTOSECOND LASIK SET

1. **K1-5191** Double-X Aspirating Speculum
 2. **K1-5691** Double-X Speculum, K-Wire, 15mm blades
 3. **K3-1770** Buratto LASIK Flap Protector
 4. **K3-2537** Thorlakson Z-LASIK™ Flap Lifter, short handle
 5. **K3-2538** IntraLase® Flap Lifter, D-E
 6. **K3-7737** Dulaney Corneal Marker
 7. **K5-5058** Buratto LASIK Flap Forceps
 8. **K7-5118** Buratto LASIK Cannula, 23ga.
 9. **K20-5010** K-Sponge II Spears, synthetic (bx)
 10. ***K9-2320** Instrument Case, small, aluminum
- *not shown

LASEK Set

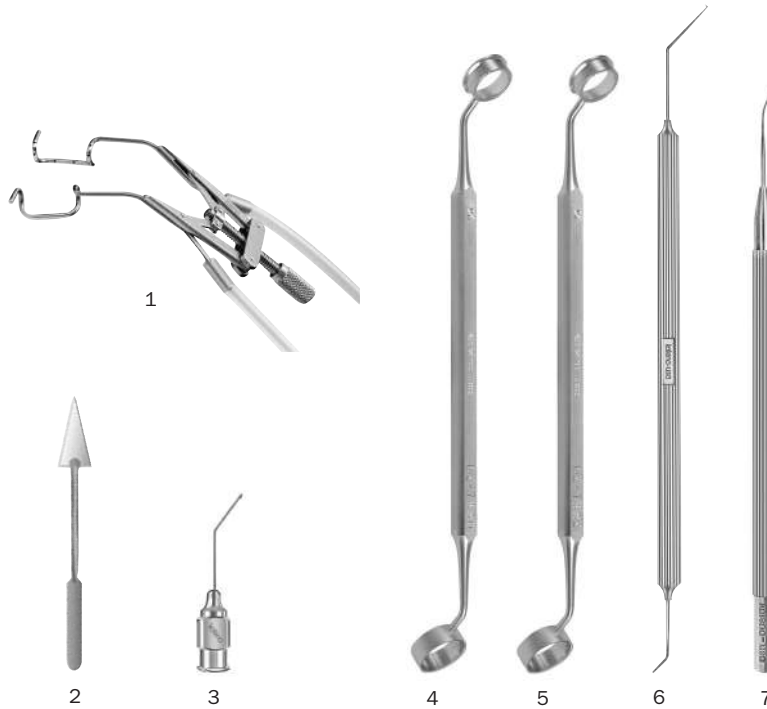

K10-1037 • LASEK SET

- | | | | |
|--------------------|-------------------------------|--------------------|---|
| 1. K1-5171 | Lieberman Aspirating Speculum | 5. K2-7832 | Trepine & Well 9/9.5mm |
| 2. K20-5010 | K-Sponge II, synthetic (bx) | 6. K3-1848 | Micro-Hoe & Epi-Peeler |
| 3. K7-3805 | Alcohol Cannula | 7. K3-1855 | Flap Repositor |
| 4. K2-7830 | Trepine & Well 8/8.5mm | 8.* K9-2320 | Instrument Case, small, aluminum
* not shown |

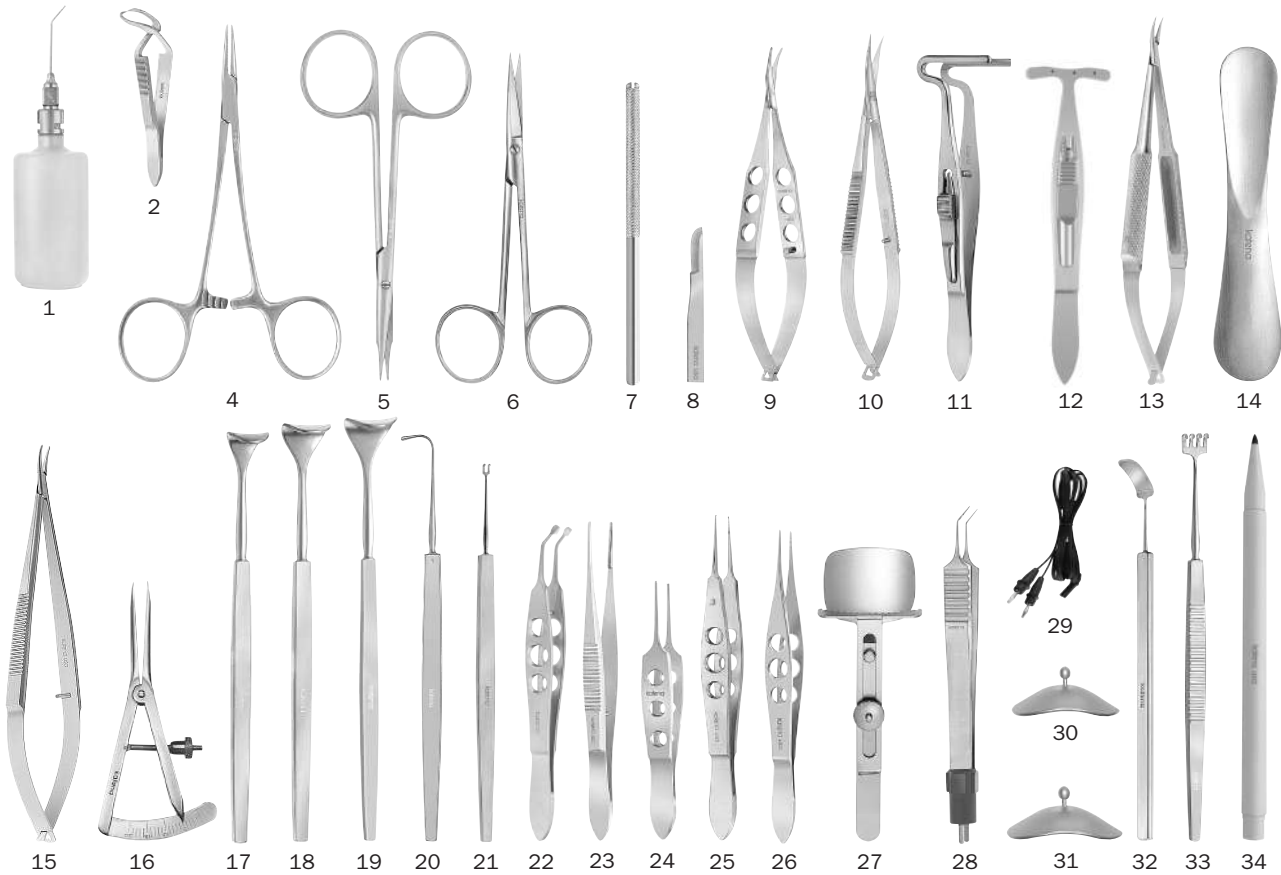

K10-1040 • LID SET

- | | |
|--|---|
| 1. K7-5000 Bishop-Harmon A/C Irrigator | 19. K1-8230 Desmarres Lid Retractor #3 |
| 2. K5-9960 Jones Towel Clamp, 2¼" | 20. K3-6720 Graefe Muscle Hook #2 |
| 3. * K5-9950 Halsted Mosquito Forceps, curved (2) | 21. K3-6000 Fixation Hook, double |
| 4. K5-9940 Halsted Mosquito Forceps, straight | 22. K5-5900 Arita Meibomian Gland Compressor |
| 5. K4-8500 Stevens Scissors, straight | 23. K5-6200 Bonaccolto Conjunctiva Forceps |
| 6. K4-7400 Eye Scissors, straight | 24. K5-3510 Bishop-Harmon Forceps |
| 7. K20-1910 Chuck Handle | 25. K5-2510 Castroviejo Forceps, 0.3mm |
| 8. K20-2467 Performance Miniature Blade #67 (bx) | 26. K5-5420 Helveston Tying Forceps |
| 9. K4-3004 Westcott Tenotomy Scissors | 27. K5-9410 Downes Lid Clamp |
| 10. K4-4100 Westcott Stitch Scissors | 28. K8-7021 Bipolar Forceps, angled, blunt |
| 11. K5-9310 Berke Ptosis Forceps | 29. K8-7065 Bipolar Cord |
| 12. K5-9315 Ptosis Lid Clamp, 6-pin, concave | 30. K1-8481 Scleral Shield, small, pair |
| 13. K6-3310 Barraquer Needle Holder, curved | 31. K1-8482 Scleral Shield, large, pair |
| 14. K1-8520 Jaeger Lid Plate, stainless steel | 32. K1-9019 Helveston Retractor, concave, 11mm |
| 15. K6-1530 Castroviejo Needle Holder, curved | 33. K1-9001 Knapp Retractor, 4-prong |
| 16. K3-9000 Castroviejo Caliper, straight | 34. K20-4500 Marking Pen, (pk/10) |
| 17. K1-8210 Desmarres Lid Retractor #1 | 35. * K9-2350 Sterilizing Case, double, aluminum |
| 18. K1-8220 Desmarres Lid Retractor #2 | |

* not shown

Oculoplastic Set

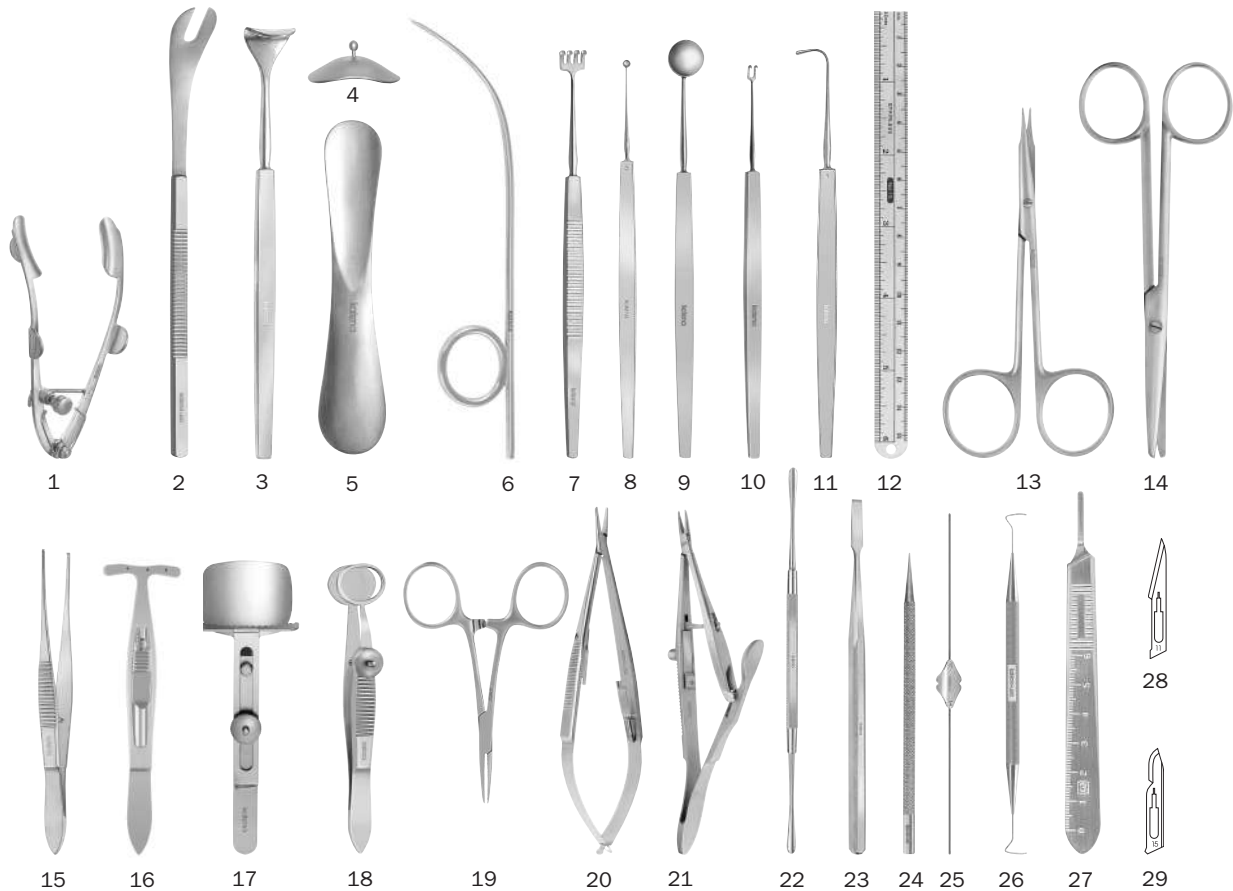

K10-1043 • OCULOPLASTIC SET

- | | | | |
|--------------------|--------------------------------------|---------------------|---|
| 1. K1-5620 | Lester-Burch Eye Speculum | 16. K5-9315 | Ptosis Lid Clamp, 6-pin, concave |
| 2. K1-7880 | Schepens Orbital Retractor | 17. K5-9410 | Downes Lid Clamp |
| 3. K1-8220 | Desmarres Lid Retractor #2 | 18. K5-9600 | Francis Chalazion Forceps |
| 4. K1-8482 | Scleral Shield, large (pair) | 19. K5-9900 | Hartmann Mosquito Forceps, straight (2) |
| 5. K1-8520 | Jaeger Lid Plate, stainless steel | 20. K6-1560 | Castroviejo Needle Holder, straight with lock |
| 6. K1-8540 | Wright Fascia Needle | 21. K6-1800 | Kalt Needle Holder |
| 7. K1-9000 | Knapp Retractor, 4-prong, blunt | 22. K7-1830 | Freer Periosteal Elevator |
| 8. K3-1030 | Meyerhoefer Curette #3 | 23. K7-1840 | West Lacrimal Chisel, straight |
| 9. K3-4410 | Bunge Evisceration Spoon | 24. K7-2120 | Wilder Lacrimal Dilator #2 |
| 10. K3-6010 | Fixation Hook, double, large | 25. K7-2540 | Bowman Lacrimal Probe #3-4 |
| 11. K3-6720 | Graefe Muscle Hook | 26. K7-2900 | Pigtail Probe |
| 12. K3-9200 | Stainless Steel Ruler | 27. K20-1950 | Bard-Parker Handle |
| 13. K4-8500 | Stevens Scissors, straight | 28. K20-1981 | Bard-Parker Blade #11 |
| 14. K4-9910 | Enucleation Scissors, medium, curved | 29. K20-1985 | Bard-Parker Blade #15 |
| 15. K5-4140 | Tissue Forceps, 1x2, straight | 30* K9-2350 | Sterilizing Case, double, aluminum |

* not shown

Chalazion Set

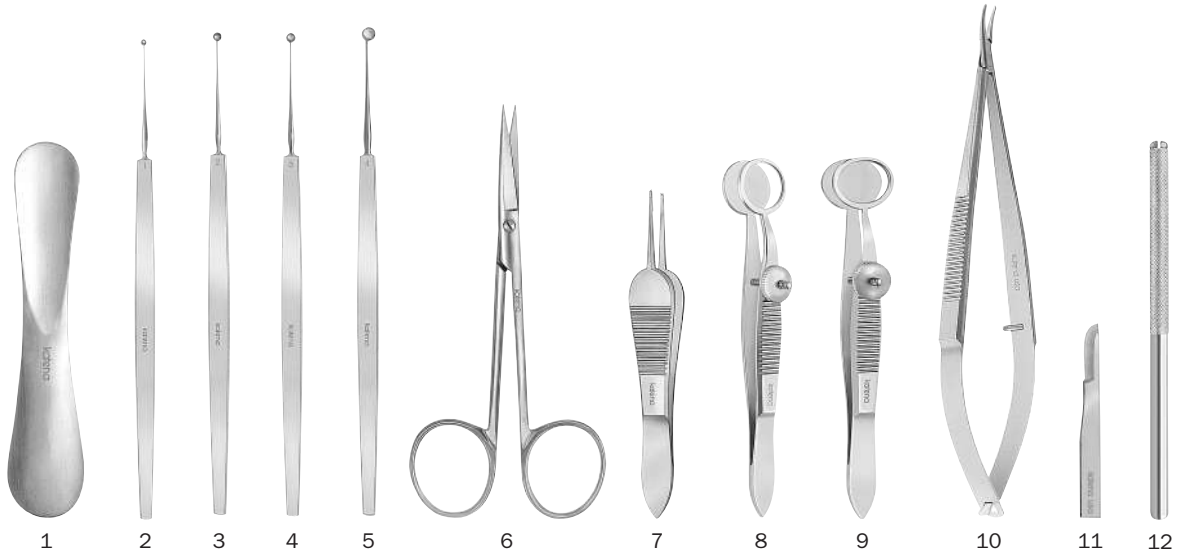

K10-1045 • CHALAZION SET

1. **K1-8520** Jaeger Lid Plate, stainless steel
 2. **K3-1010** Meyerhoefer Curette #1
 3. **K3-1020** Meyerhoefer Curette #2
 4. **K3-1030** Meyerhoefer Curette #3
 5. **K3-1040** Meyerhoefer Curette #4
 6. **K4-7410** Eye Scissors, curved
 7. **K5-3562** Manhattan Eye & Ear Suture Forceps
 8. **K5-9500** Hunt Chalazion Forceps
 9. **K5-9600** Francis Chalazion Forceps
 10. **K6-1530** Castroviejo Needle Holder, curved
 11. **K20-2467** Performance Miniature Blade #67 (bx)
 12. **K20-1910** Chuck Handle
 13. * **K9-2030** Sterilizing Case, large, plastic
- * not shown

Strabismus Set

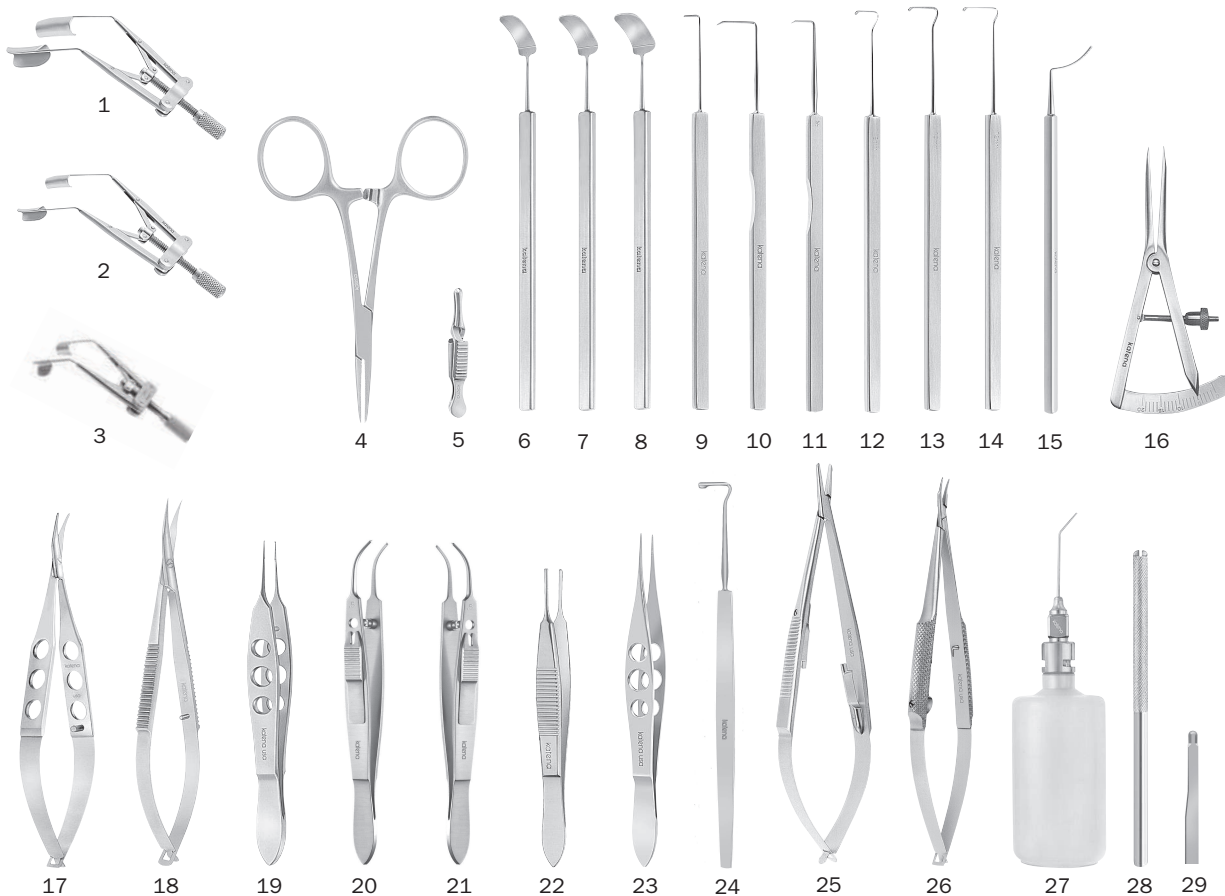

K10-2050 • STRABISMUS SET

- | | | | | | |
|-----|----------------|--|-----|-----------------|---|
| 1. | K1-5678 | Lieberman Speculum, solid blade, large | 16. | K3-9000 | Castroviejo Caliper, straight |
| 2. | K1-5677 | Lieberman Speculum, solid blade, small | 17. | K4-3004 | Westcott Tenotomy Scissors |
| 3. | K1-5665 | Lieberman Infant Speculum, solid blade | 18. | K4-4100 | Westcott Stitch Scissors |
| 4. | K5-9910 | Hartmann Mosquito Forceps, curved (2) | 19. | K5-2020 | Bonn Forceps, 0.12mm |
| 5. | K5-9850 | Serrefine, small, straight (2) | 20. | K5-2553 | Moody Fixation Forceps, left |
| 6. | K1-9010 | Helveston "Barbie" Retractor | 21. | K5-2554 | Moody Fixation Forceps, right |
| 7. | K1-9012 | Helveston "Big Barbie" Retractor | 22. | K5-4320 | Lester Fixation Forceps, 2x3 (3) |
| 8. | K1-9019 | Helveston "Great Big Barbie" Retractor | 23. | K5-5420 | Helveston Tying Forceps (2) |
| 9. | K3-6610 | Helveston Teaser Hook, 6mm (3) | 24. | K3-6830 | Rychwalski Muscle Hook, with grooves |
| 10. | K3-6760 | Helveston Finder Hook, large | 25. | K6-1560 | Castroviejo Needle Holder, straight, w/lock |
| 11. | K3-6761 | Helveston Finder Hook, small | 26. | K6-3520 | Barraquer Needle Holder, curved, w/lock |
| 12. | K3-6778 | Helveston Muscle Hook, 8mm | 27. | K7-5000 | Bishop-Harmon A/C Irrigator |
| 13. | K3-6780 | Helveston Muscle Hook, 10mm | 28. | K20-1910 | Chuck Handle |
| 14. | K3-6782 | Helveston Muscle Hook, 12mm | 29. | K20-2469 | Performance Miniature Blade #69 (bx) |
| 15. | K3-9030 | Helveston Scleral Ruler | 30. | *K9-2350 | Sterilizing Case, double, aluminum |

*not shown

Technique Video Available

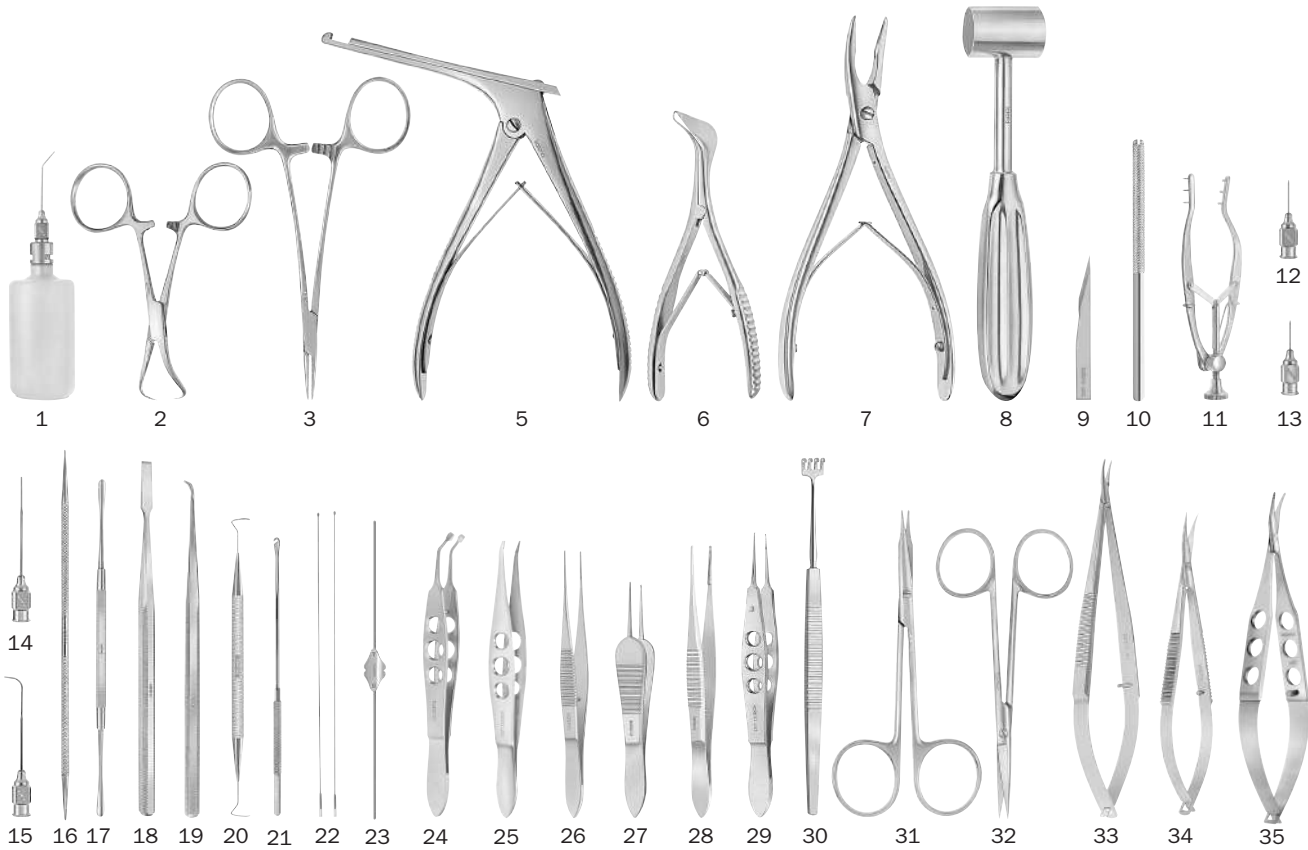

K10-1055 • LACRIMAL SET

- | | |
|--|---|
| 1. K7-5000 Bishop-Harmon A/C Irrigator | 20. K7-2900 Pigtail Probe |
| 2. K5-9964 Backhaus Towel Clamp (2) | 21. K7-2623 Crawford Retrieving Hook |
| 3. K5-9940 Halsted Mosquito Forceps, straight (2) | 22. K7-2620 Crawford Lacrimal Intubation Set |
| 4. * K5-9950 Halsted Mosquito Forceps, curved (2) | 23. K7-2500 Bowman Lacrimal Probe Set of 6 |
| 5. K7-1801 Kerrison Rongeur, size 1 | 24. K5-5900 Arita Meibomian Gland Compressor |
| 6. K7-1822 Nasal Speculum, adult | 25. K5-6218 Gold Punctal Plug Forceps |
| 7. K7-1810 Beyer Rongeur | 26. K5-4000 Dressing Forceps, delicate, straight |
| 8. K7-1860 Mallet, lead filled stainless steel | 27. K5-3560 Sauer Fixation Forceps, 1x2 |
| 9. K20-2465 Performance Miniature Blade #65 (bx) | 28. K5-6210 Bonaccolto Conjunctiva Forceps |
| 10. K20-1910 Chuck Handle | 29. K5-2510 Castroviejo Forceps, 0.3mm |
| 11. K1-9500 Stevenson Retractor | 30. K1-9000 Knapp Retractor, 4-prong, blunt (2) |
| 12. K7-3014 Shahinian Lacrimal Cannula | 31. K4-8510 Stevens Scissors, curved |
| 13. K7-3016 Burnstine Lacrimal Cannula | 32. K4-7400 Eye Scissors, straight |
| 14. K7-3000 Lacrimal Cannula, straight | 33. K6-1520 Castroviejo Needle Holder, curved w/lock |
| 15. K7-3010 Lacrimal Cannula, curved | 34. K4-4100 Westcott Stitch Scissors |
| 16. K7-2300 Castroviejo Lacrimal Dilator | 35. K4-3130 Tibolt Punctal Scissors |
| 17. K7-1830 Freer Periosteal Elevator | 36. * K20-5000 K-Sponge Spears, sterile (bx) |
| 18. K7-1840 West Lacrimal Chisel, straight | 37. * K9-2350 Sterilizing Case, double, aluminum |
| 19. K7-1845 Freer Lacrimal Chisel, curved | |

*not shown

Vitreoretinal Set

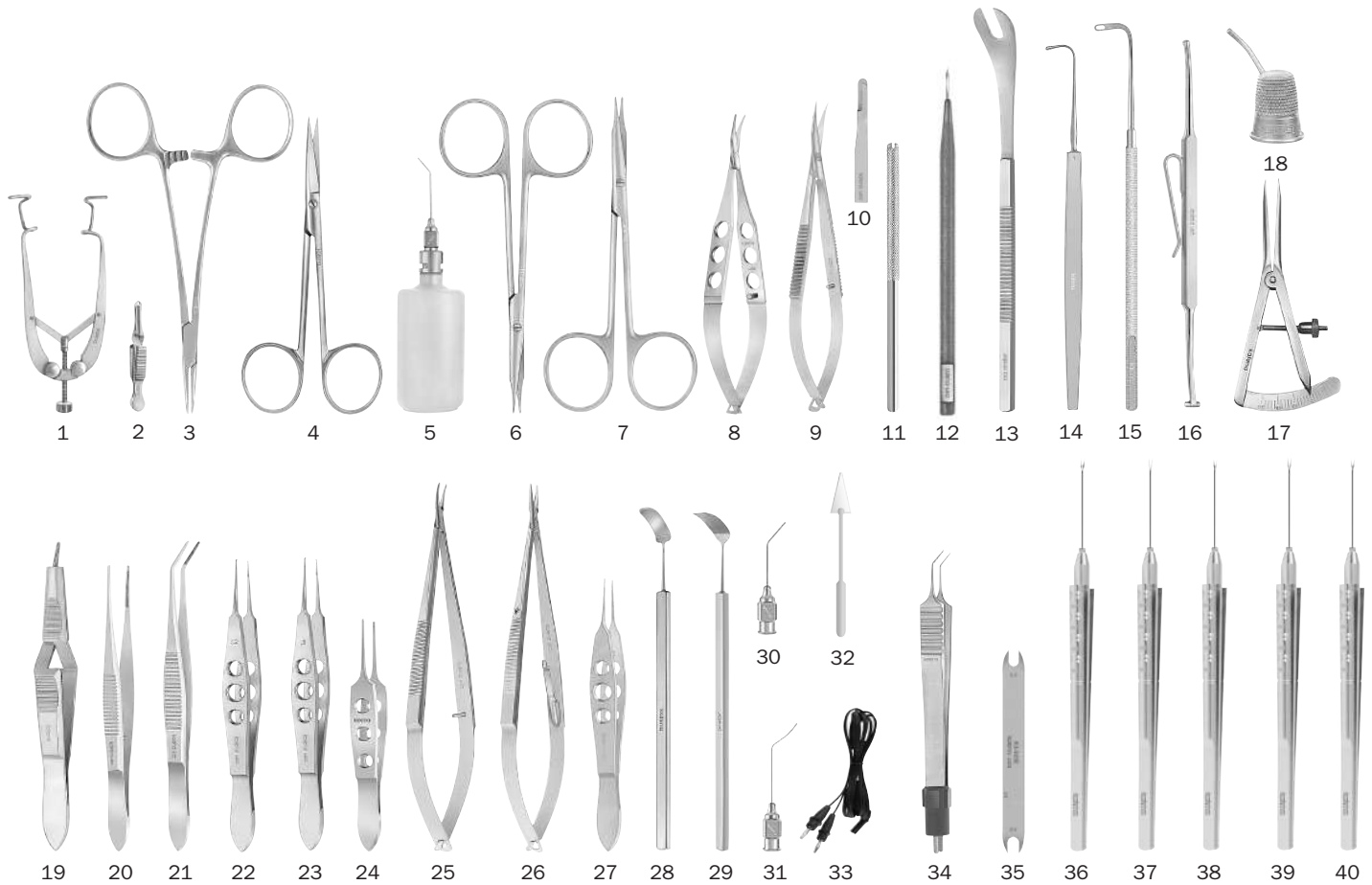

K10-1060 • VITREORETINAL SET, 23 GAUGE

- | | | | |
|---------------------|--|----------------------|--|
| 1. K1-5711 | Fishkind-Castroviejo Speculum | 22. K5-2500 | Castroviejo Forceps, 0.12mm |
| 2. K5-9850 | Serrefine, small, straight (4) | 23. K5-2510 | Castroviejo Forceps, 0.3mm |
| 3. K5-9940 | Halsted Mosquito Forceps, straight (2) | 24. K5-3510 | Bishop-Harmon Forceps (2) |
| 4. K4-7400 | Eye Scissors, straight | 25. K6-1520 | Castroviejo Needle Holder, curved, w/lock |
| 5. K7-5000 | Bishop-Harmon A/C Irrigator | 26. K6-1500 | Castroviejo Needle Holder, straight |
| 6. K4-8500 | Stevens Scissors, straight | 27. K5-5000 | McPherson Tying Forceps, straight |
| 7. K4-8510 | Stevens Scissors, curved | 28. K1-9010 | Helveston Barbie Retractor |
| 8. K4-3004 | Westcott Tenotomy Scissors | 29. K1-9019 | Helveston Retractor, concave, 11mm |
| 9. K4-4100 | Westcott Stitch Scissors | 30. K7-3550 | Viscoelastic Aspiration Cannula, 22ga. |
| 10. K20-2464 | Miniature Blade #64 (bx) | 31. K7-3620 | Randolph Cyclodialysis Cannula, 19ga. |
| 11. K20-1910 | Chuck Handle | 32. K20-5000 | K-Sponge Spears (bx) |
| 12. K20-2286 | MVR Knife, 1.5mm, 19 gauge | 33. K8-7065 | Bipolar Cord |
| 13. K1-7880 | Schepens Orbital Retractor | 34. K8-7021 | Bipolar Forceps, angled, blunt |
| 14. K3-6720 | Graefe Muscle Hook #2 | 35. K3-9250 | Braunstein Caliper, 3.5/4.0mm |
| 15. K3-6740 | Gass Retinal Detachment Hook | 36. K4-5423 | Squeeze Handle Scissors, horizontal, curved, 23ga. |
| 16. K1-7825 | Schocket Scleral Depressor | 37. K5-7703 | Squeeze Handle Forceps, serrated jaws, 23ga. |
| 17. K3-9000 | Castroviejo Caliper, straight | 38. K5-7713 | Squeeze Handle Forceps, end gripping, 23ga. |
| 18. K1-7790 | Gass Scleral Marker | 39. K5-7723 | Squeeze Handle Forceps, asymmetrical, 23ga. |
| 19. K5-7950 | Watzke Sleeve Spreading Forceps | 40. K5-7733 | Squeeze Handle Forceps, ILM, 23ga. |
| 20. K5-6200 | Bonaccolto Conjunctiva Forceps | 41. * K9-2350 | Sterilizing Case, double, aluminum |
| 21. K5-6215 | Nugent Utility Forceps, serrated | | * not shown |

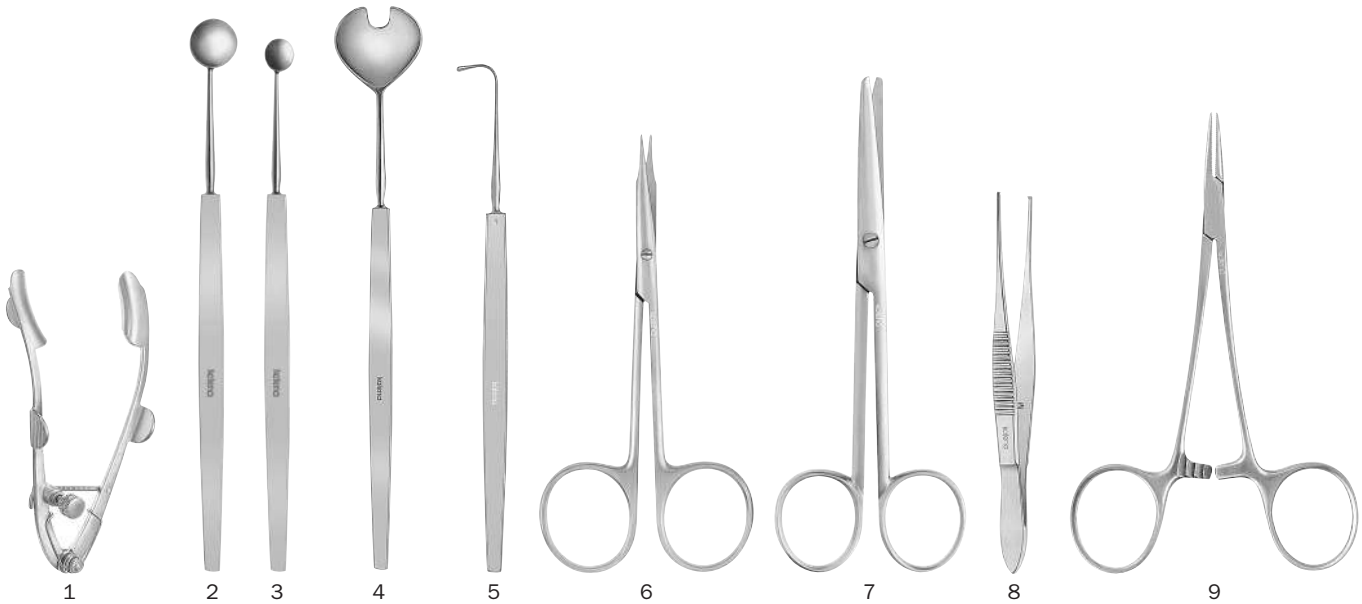

K10-1065 • ENUCLEATION SET

1. **K1-5620** Lester-Burch Eye Speculum
2. **K3-4410** Bunge Evisceration Spoon, large
3. **K3-4400** Bunge Evisceration Spoon, small
4. **K3-4450** Wells Enucleation Spoon
5. **K3-6720** Graefe Muscle Hook #2
6. **K4-8500** Stevens Scissors, straight
7. **K4-9920** Enucleation Scissors, strong curve
8. **K5-4140** Tissue Forceps
9. **K5-9950** Halsted Mosquito Forceps, curved
10. ***K9-2030** Sterilizing Case, large, plastic
* not shown

Pterygium Set

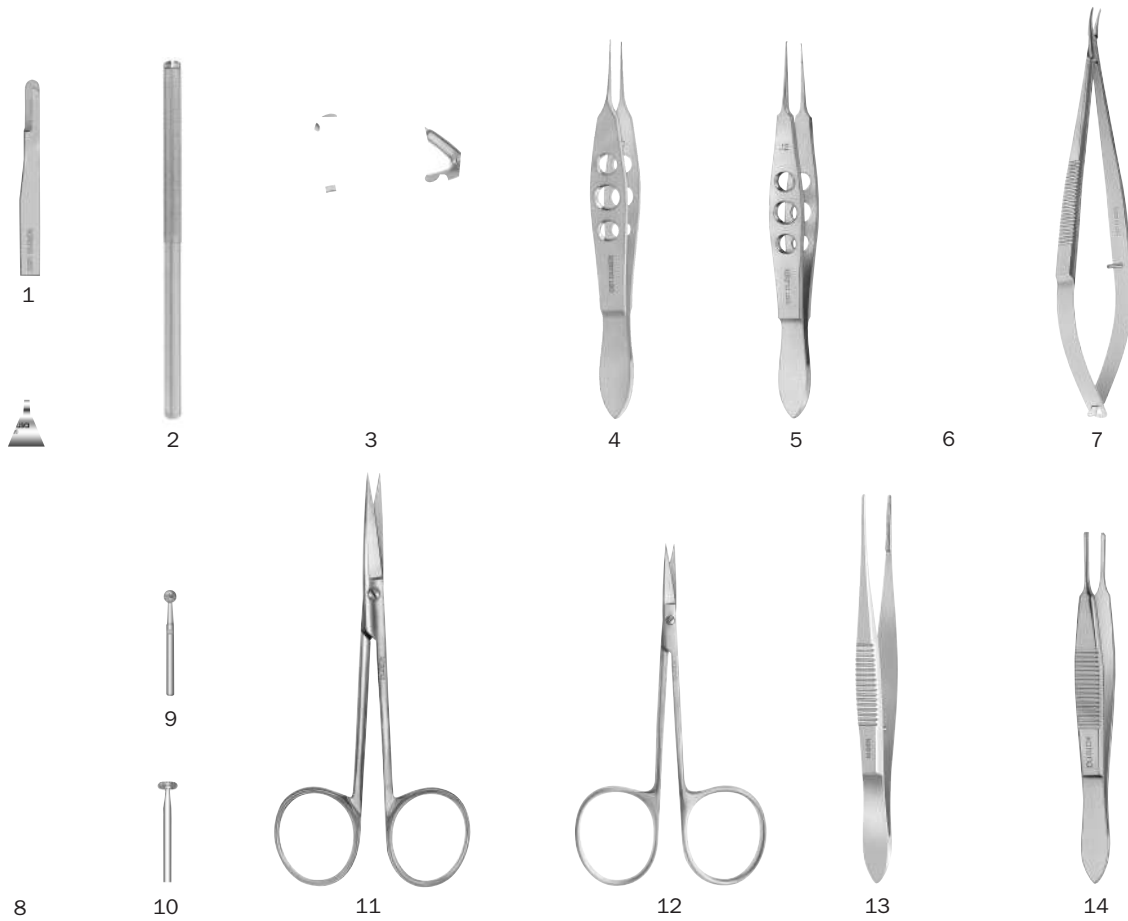

K10-1070 • PTERYGIUM SET

- | | |
|---|--|
| 1. K20-2464 Miniature Blade #64, disposable (bx) | 8. K2-4920 Katena Ophthalmic Burr |
| 2. K20-1910 Chuck Handle | 9. K2-4925 Diamond Burr, 5.0mm diameter ball |
| 3. K1-5600 Lancaster Eye Speculum | 10. K2-4935 Diamond Burr, 5.0mm diameter disc |
| 4. K5-5000 McPherson Tying Forceps, straight | 11. K4-7400 Eye Scissors, straight, standard |
| 5. K5-2500 Castroviejo Forceps, 0.12mm | 12. K4-7200 Eye Scissors, straight, small |
| 6. K2-3700 Gill Corneal Knife | 13. K5-6200 Bonaccolto Conjunctiva Forceps |
| 7. K6-1530 Castroviejo Needle Holder, curved | 14. K5-4320 Lester Fixation Forceps |
| | 15. *K9-2030 Sterilization Case, large, plastic |

* not shown

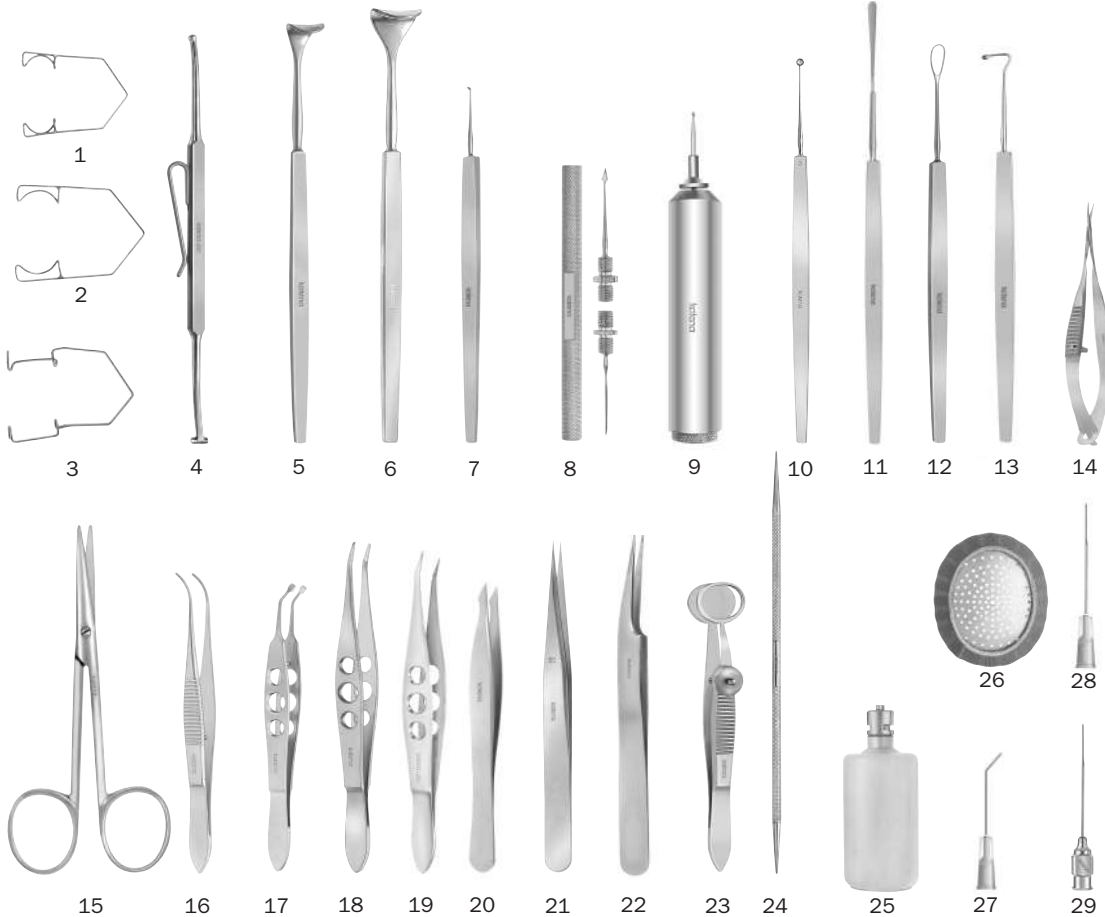

K10-1080 • OFFICE SET

- | | |
|---|--|
| 1. K1-5000 Barraquer Wire Speculum, 10mm blades | 16. K5-4010 Dressing Forceps, curved |
| 2. K1-5010 Barraquer Wire Speculum, 15mm blades | 17. K5-5900 Arita Meibomian Gland Compressor |
| 3. K1-5050 Kratz-Barraquer Wire Speculum, 15mm blades | 18. K5-6000 Barraquer Cilia Forceps, lightly angled |
| 4. K1-7825 Schocket Scleral Depressor | 19. K5-6218 Gold Punctal Plug Forceps |
| 5. K1-8200 Desmarres Lid Retractor, size 0, 11mm wide | 20. K5-6020 Katena Cilia Forceps |
| 6. K1-8220 Desmarres Lid Retractor, size 2, 15mm wide | 21. K5-6520 Jewelers Forceps, delicate, straight |
| 7. K2-4000 Golf Club Foreign Body Spud | 22. K5-6575 Suture Removal Forceps |
| 8. K2-4600 Spud & Gouge, in reversible handle | 23. K5-9600 Francis Chalazion Forceps, oval |
| 9. K2-4900 Algerbrush II, complete with "AA" battery and two burrs | 24. K7-2300 Castroviejo Lacrimal Dilator, double-end |
| 10. K3-1030 Meyerhoefer Chalazion Curette, size 3, 2.5mm dia. | 25. K7-5005 Bishop-Harmon A/C Irrigator |
| 11. K3-3500 Kimura Platinum Spatula | 26. K9-6010 Fox Aluminum Eye Shield, adult |
| 12. K3-4030 New Orleans Lens Loop | 27. K20-3142 Bishop-Harmon Cannula, 19ga., sterile, disp. (bx/10) |
| 13. K3-6800 Jameson Muscle Hook, small | 28. K20-3280 Lacrimal Cannula, 19ga., sterile, disp. (bx/10) |
| 14. K4-5100 McPherson-Vannas Iris Scissors, curved | 29. K7-3000 Lacrimal Cannula, 23ga. straight |
| 15. K4-9000 Knapp Stabismus Scissors, straight | 30.* K9-2350 Sterilizing Case, double, aluminum |

* not shown

Veterinary Ophthalmic Set

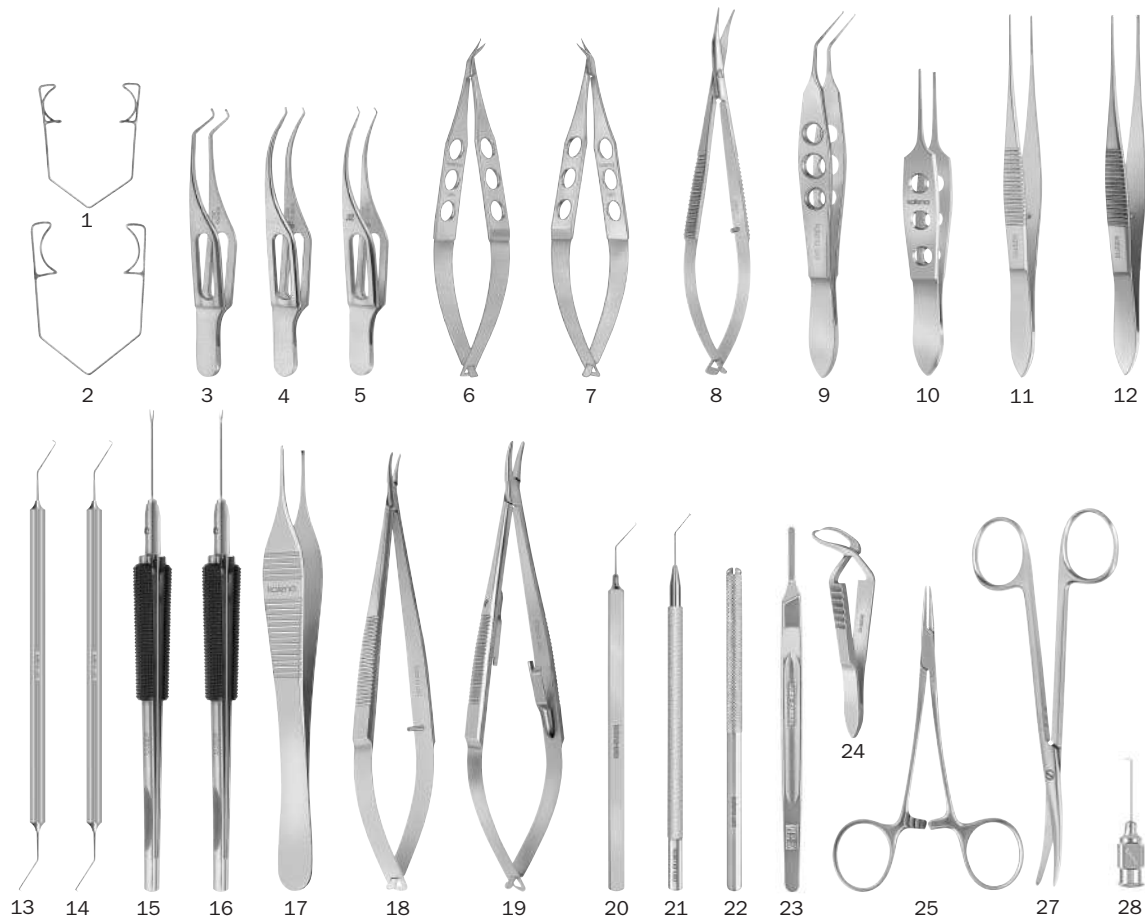

K10-1090 • VETERINARY OPHTHALMIC SET

- | | | | |
|--------------------|--|---------------------|---|
| 1. K1-5000 | Barraquer Wire Speculum, small | 16. K4-5210 | Intraocular Scissors, angled 30° |
| 2. K1-5010 | Barraquer Wire Speculum, large | 17. K5-4170 | Adson Tissue Forceps |
| 3. K5-1050 | Iris Forceps | 18. K6-1520 | Castroviejo Needle Holder, curved, w/lock |
| 4. K5-1550 | Colibri Forceps, 1x2 teeth, 0.4mm | 19. K6-1580 | Castroviejo Needle Holder, heavy, curved |
| 5. K5-1520 | Harms-Colibri Forceps, 0.12mm | 20. K3-5230 | Sinsky Lens Hook, angled |
| 6. K4-1000 | Castroviejo Corneal Scissors, small, right | 21. K3-2410 | Jaffe-Bechert Rotator, 9mm |
| 7. K4-1010 | Castroviejo Corneal Scissors, small, left | 22. K20-1910 | Chuck Handle (2) |
| 8. K4-3100 | Westcott Tenotomy Scissors | 23. K20-1970 | Bard-Parker Handle |
| 9. K5-5081 | Utrata Capsulorrhexis Forceps | 24. K5-9960 | Jones Towel Clamp (4) |
| 10. K5-3510 | Bishop-Harmon Forceps | 25. K5-9940 | Halsted Mosquito Forceps, straight (2) |
| 11. K5-4000 | Dressing Forceps, delicate, straight | 26. *K5-9950 | Halsted Mosquito Forceps, curved (2) |
| 12. K5-4100 | Tissue Forceps, delicate, straight | 27. K4-9040 | Metzenbaum Dissecting Scissors |
| 13. K3-2369 | Chang Phaco Chopper | 28. K7-5464 | Chang Hydrodissection Cannula |
| 14. K3-2379 | Warren Canine Phaco Chopper | 29. *K9-2350 | Instrument Case, double, aluminum |
| 15. K4-5200 | Intraocular Scissors, straight | | *not shown |

A

Adaptor, Luer	154, 168
Adson Forceps	104
Agarwal Karate Phaco Chopper	41
Agarwal Phaco Chopper	41
Agricola Lacrimal Sac Retractor	19
Air Injection Cannula	147, 148, 186, 187
AK Knife	24
Akahoshi Combo PreChopper	117
Akahoshi Phaco PreChopper	117
Akahoshi Sustainer	38
Aker Lens Pusher	52
Alcohol Well	27, 32
Alfonso Cataract Set - Manual	220
Alfonso Cutting Platform	56
Alfonso Nucleus Forceps	118
Alfonso Nucleus Trisector	55
Alfonso-McIntyre Nucleus Spoon	161
Algerbrush Rust Ring Remover	22
Alignment Marker	73
Alio Capsulorrhexis Forceps	121
Alio Irrigating Stinger, oval	166
Alio MICS Scissors	89
Alio Scimitar PreChopper	35
Alio-Kelman IOL Hook	52
Alphonso Infant Speculum	5
Aluminum Eye Shield	177
Aluminum Tray	175, 176
Ambio2™ Amniotic Membrane	201
Ambio5® Amniotic Membrane	202
AmbioDisk™ Amniotic Membrane	200
Amniotic Membrane Graft	200-202
Anesthesia Cannula	149, 186
Anis Capsule Scrubber	30
Anis Cortex Extractor	159
Anis Needle Holder	137
Anis Nucleus Manipulator	45
Anis Phaco Chopper	36
Anis Radial Marker	75
Anis Suture Placement Marker	76
Anis Tying Forceps	111
Anterior Chamber Base	182
Anterior Chamber Caliper	78
A/C Cannula 147,154-157, 160, 186, 187, 190	
Anterior Chamber Maintainer	161, 162, 182
Arbisser A/C Cannula	147, 186
Arcuate Incision Knife	23, 24
Arcuate Incision Marker	72, 74
Arita Meibomian Compressor	113
Arruga Capsule Forceps	117
Artificial Anterior Chamber	182
Aspirating Cannula	147, 157-159, 191, 192
Aspirating Speculum	4
Aspirating Speculum, reversible	4
Aspiration Handle	163, 164
Aspiration Handpiece	164
Aspiration Handpiece, oval	164
Astigmatism Marker	72, 74
Atkinson Retrobulbar Needle	149, 186
Axis Gauge	72, 73
Axis Marker	72, 74

B

Baby Jones Towel Clamp	132
Backhaus Towel Clamp	132
Baird Chalazion Forceps	130
Ball Tip Chopper	36
Ball Tip Nucleus Manipulator	45
Banaji LASIK Cannula	156
"Barbie" Retractor	18
Bard-Parker Blade	180
Bard-Parker Handle	180
Barraquer Cilia Forceps	113
Barraquer Infant Wire Speculum	1, 6
Barraquer Iris Scissors	86
Barraquer Iris Spatula	35
Barraquer Needle Holder	135, 136, 137
Barraquer Wire Speculum	1, 2, 3, 6
Barron Artificial Anterior Chamber	182
Barron Artificial Anterior Chamber Base	182
Barron Corneal Punch	181, 182
Barron Corneal Trepine	181
Barron Vacuum Trepine	181
Base for Barron Artificial A/C	182
Bayonet Dressing Forceps	104
Bechert Forceps	105
Bechert Lens Holding Forceps	126
Bechert Lens Pusher	52
Bechert Nucleus Rotator	43, 44
Benedetto IntraLase® Spatula	47
Berke Ptosis Forceps	128
Beyer Rongeur	140
B H Kim Intraocular Mirror	65
Bi-Manual Chopper	35, 42
Bi-Manual Irrigating Cannula, disposable	192
Bi-Manual I/A System	164
"Big Barbie" Retractor	18
"Big Bubble" Technique Cannula	148
"Big Bubble" Technique Scissors	81, 87
"Big Bubble" Technique Spatula	34
"Big Spurt" Hydroexpression Cannula	189
Binder IntraLase® Flap Elevator	48
BioElevation™ Fascia Lata Sling	208
Bipolar Cord	170
Bipolar Forceps	169, 170
Bisector, Nucleus	56
Bishop Muscle Hook	71
Bishop-Harmon A/C Irrigator	154
Bishop-Harmon Cannula	154, 194
Bishop-Harmon Forceps	103
Blade Breaker & Holder	23
Blade Fragments	180
Blade Gauge	25
Blade Handle	180, 183
Blade, Bard-Parker	180
Blade, Disposable	180, 183, 185
Blade, Dissecting	20, 185
Blade, Keratome	26, 27, 185
Blade, Lamellar	20, 185
Blade, Miniature	185
Blade, Phaco	26, 27, 185
Blade, Scleral Trepine	183
Blade, Sclerotome	185
Blade, Trepine	183
Blaydes Lens Holding Forceps	127
Blepharoplasty Lid Clamp	129
Blepharoplasty Surgery Set	231

Blepharostat	1-14
Blumenthal A/C Maintainer	162
Blumenthal Conjunctiva Dissector	31
Boat Hook Manipulator	63
Bodian Lacrimal Probe Set	145
Bohm Irrigating Iris Retractor	165
Bonaccolto Conjunctiva Forceps	114
Bone Rongeur	139, 140
Bonfadini DALK Spatula	34
Bonn Forceps	99
Bonn Micro Iris Hook	60
Bores Axis Marker	72
Bores Optic Zone Marker	75
Botvin Iris Forceps	96
Bowman Lacrimal Probe	144
Bracken Fixation Forceps	105
Bracken Irrigating Cannula	156
Braunstein Caliper	78
Brierley Chamber Maintainer	162
Brierley LASIK Cannula	156
Brierley Nucleus Splitter	41
Bubble Alignment Marker	73
Bucher-Kansas Nucleus Trisector	55
Bulb, Silicone	154
Bull Dog Clamp	131
Bunge Evisceration Spoon	57
Buratto IOL Inserting Forceps	126
Buratto LASIK Cannula	157
Buratto LASIK Flap Protector	31
Buratto LASIK Forceps	106
Burnstine Lacrimal Cannula	146
Burr, Corneal	21, 22
Burr, Diamond	22
Burr, Foreign Body	21, 22

C

Caliper	77, 78
Camellin Trepine	27
Camellin Well	27, 32
Canine Nucleus Chopper	41
Cannula, A/C .. 147, 154-157, 160, 186, 187, 192	
Cannula, Air Injection	147, 148, 186, 187
Cannula, Anesthesia	149, 186
Cannula, Aspirating	147, 157-159, 191, 192
Cannula, Bi-Manual I/A	155, 158, 191, 192
Cannula, Capsule Polishing	152-154, 192, 193
Cannula, Capsule Staining	147
Cannula, Capsulorrhexis	189
Cannula, Cortex	157-159, 191, 192, 193
Cannula, Cyclodialysis	148
Cannula, DALK	148
Cannula, Disposable	186-195
Cannula, HydroChop	160
Cannula, Hydrodissect .. 154,155,159,160,189-191	
Cannula, Hydroexpression	189
Cannula, I/A	149-151, 192
Cannula, Incision Sealing	187
Cannula, Infusion	161, 162, 194
Cannula, IntraLasik®	195
Cannula, Irrigating .. 58,154-156,160,161,192,194	
Cannula, J-shaped	159, 190, 191
Cannula, Lacrimal	146, 194
Cannula, LASEK	148

Index

Cannula, LASIK.....	156-158, 195	Chopper, Vertical.....	36-38, 40, 42	Curette, Capsule Polishing.....	30, 152
Cannula, MSICS.....	150	Christensen Punctum Punch.....	29	Curette, Chalazion.....	30
Cannula, Nucleus Prolapsing.....	155	Chu Aspirating Handpiece.....	164	Cutter, IOL.....	90
Cannula, Olive Tip.....	148, 153, 193	Chu Aspirating Speculum.....	4	Cyclodialysis Cannula.....	148
Cannula, Retrobulbar.....	149, 186	Chu Femto Speculum.....	11	Cyclodialysis Spatula.....	52, 53
Cannula, Silicone Oil.....	146	Chu Hydrodissection Cannula.....	155	Cystotome.....	151, 152
Cannula, Silicone Tip.....	193	Chu Irrigating Handpiece.....	164	Cystotome, Disposable.....	188, 189
Cannula, Small Incision I/A.....	150	Chu LRI Knife.....	23		
Cannula, Sub-Tenon's.....	149, 186	Chu LRI Marker.....	74		
Cannula, U-shaped.....	150, 159, 160	Chu Reversible Aspirating Speculum.....	4		
Cannula, Viscoelastic Aspirating.....	147	Chuck Handle.....	180		
Cannula, Viscoelastic Injection.....	187	Cilia Forceps.....	113		
Capsule Forceps.....	107-110, 117, 121	Citelli Rougeur.....	139		
Capsule Fragment Forceps.....	105	Clamp, Lid.....	129		
Capsule Polisher.....	30, 152-154, 192, 193	Clamp, Ptois.....	128, 129		
Capsule Polishing Cannula.....	152-154, 192, 193	Clamp, Towel.....	131, 132		
Capsule Polishing Curette.....	30, 152	Clasen ICL™ Manipulator.....	64		
Capsule Scrubber.....	30	Clayman Lens Holding Forceps.....	128		
Capsule Staining Cannula.....	147	Clayman Nucleus Rotator.....	44		
Capsule Tag Forceps.....	107	Clayman-Jaffe Lens Hook.....	60		
Capsulorrhexis Forceps.....	107-110, 121	Cleaning Tube for Squeeze Handle.....	171		
Capsulorrhexis Marker.....	71	Clear Cornea Patch Graft.....	206		
Capsulotomy Marker.....	71	Clear Corneal Knife.....	26, 27, 184		
Capsulotomy Scissors.....	87	Clover Leaf Hook.....	63		
Carter LASIK Cannula.....	156	Coagulating Forceps.....	169, 170		
Carter Sphere Introducer.....	169	Coaxial I/A System.....	167, 168		
Cartridge Loading Forceps, ICL™.....	120, 123	Cobra Cannula.....	148		
Case, Sterilizing.....	25, 172-176	Colibri Forceps.....	96-99, 102		
Castroviejo Blade Breaker.....	23	Collar Button Iris Retractor.....	58, 165		
Castroviejo Caliper.....	77	Compressor, Meibomian Gland.....	113		
Castroviejo Cyclodialysis Spatula.....	53	Conformer, Universal.....	169		
Castroviejo Eye Speculum.....	12	Conjunctiva Dissector.....	31		
Castroviejo Forceps.....	101	Conjunctiva Forceps.....	98, 114		
Castroviejo Corneal Scissors.....	79, 80, 82	Conjunctiva Retractor.....	18		
Castroviejo Lacrimal Dilator.....	143	Conjunctiva Scissors.....	82-84, 93		
Castroviejo Needle Holder.....	133, 134	Contingency Set.....	214		
Castroviejo Scissors.....	79, 80, 82	Controller, Endocapsular.....	45		
Castroviejo Synechiae Spatula.....	53	Cook Eye Speculum.....	6		
Castroviejo-Colibri Forceps.....	98	Corbin Anesthesia Cannula.....	149		
Catalano Lacrimal Intubation Set.....	144	Cord, Bipolar.....	170		
Cataract Surgery Set (Femto).....	213	Cornea Patch Graft.....	206		
Cataract Surgery Set (Manual Phacofracture).....	220	Corneal Burr.....	21, 22		
Cataract Surgery Set (MICS).....	219	Corneal Button Spoon.....	57		
Cataract Surgery Set (MSICS).....	221	Corneal Caliper.....	78		
Cataract Surgery Set (Phaco).....	217	Corneal Cross-Linking (CXL).....	182		
Cataract Surgery Set (Phaco PreChop).....	218	Corneal Dissector.....	20, 34, 50		
Cataract Surgery Set (Planned ECCE).....	212	Corneal Forceps.....	96-100, 102, 120, 122		
CCC Cystotome Formed.....	189	Corneal Knife.....	20, 23, 24, 184		
Chalazion Curette.....	30	Corneal Light Shield.....	199		
Chalazion Forceps.....	130	Corneal Marker.....	71-76		
Chalazion Surgery Set.....	233	Corneal Punch.....	181, 182		
Chamber Maintainer.....	161, 162, 194	Corneal Roller.....	196		
Chang Contingency Set.....	214	Corneal Rust Ring Remover.....	22		
Chang HydroChopper.....	166	Corneal Scissors.....	79-82, 87		
Chang Hydrodissection Cannula.....	160, 190	Corneal Suture Placement Marker.....	76		
Chang Micro Finger.....	36, 40, 41, 166	Corneal Suturing Forceps.....	96, 97		
Chang Phaco Chopper.....	36, 40, 41, 166	Corneal Transplant Scissors.....	80, 81		
Chang-Seibel Chopper.....	36	Corneal Transplant Surgery Set.....	225		
Charleux Cortex Extractor.....	192	Corneal Trephine Blade.....	183		
Chayet Corneal Marker.....	71	Corneoscleral Forceps.....	96-100, 102		
Chayet LASIK Drain.....	198	Corneoscleral Punch.....	28, 29		
Chisel, Lacrimal.....	141	Corneoscleral Scissors.....	79, 80		
Chisel Tip Spatula.....	40	Cortex Aspirating Cannula.....	157-159, 191, 192		
Chopper, Ball Tip.....	36	Cracker, Nucleus.....	118		
Chopper, Bimanual.....	35, 42	Crawford Lacrimal Intubation Set.....	145		
Chopper, Chang.....	36, 40, 41, 166	Crawford Retrieving Hook.....	145		
Chopper, Irrigating.....	166	Crescent Diamond Knife.....	26		
Chopper, MICS.....	35	Crescent Knife.....	26, 184		
Chopper, Nucleus.....	35-38, 40-43, 166	Culler Iris Spatula.....	34		
Chopper, Seibel.....	36	Culler Lens Spoon.....	56		

D

Dahan-Blumenthal ACM, oval.....	162
Dahan Cortex Asp Cannula.....	159
Dahan Nucleus Prolapsing Cannula.....	155
DALK Air Injection Cannula.....	148
DALK Corneal Dissector.....	34
DALK Instruments.....	34, 81, 87, 148
DALK Scissors.....	81, 87
DALK Spatula.....	34
DALK Surgery Set.....	226
DCR Surgery Set.....	235
De La O Aspirating Cannula.....	158
Degree Gauge.....	72, 73
Dehydrated Amniotic Membrane Graft.....	200-202
Deitz Lens Manipulator.....	64
Depressor, Scleral.....	15
Descemet's Membrane Punch.....	28, 29
Descemetorrhexis Forceps.....	110
Desmarres Chalazion Forceps.....	130
Desmarres Lid Retractor.....	16
Diamond Burr.....	22
Diamond Keratome.....	26, 27
Diamond Knife.....	23-27
Diamond Knife Sterilizing Case.....	25, 172
Diamond Knife, Crescent.....	26
Diamond Knife, LRI.....	23, 24
Diamond Knife, Trapezoid.....	27
Diamond Phaco Knife.....	26, 27
Diamond Step Knife.....	23, 24, 26
Dilator, Lacrimal.....	142, 143
Dilator, Small Pupil.....	59
Disposable Blade.....	180, 183, 185
Disposable Cannula.....	186-195
Disposable Corneal Punch.....	181, 182
Disposable Corneal Trephine.....	181, 183
Disposable Instrument Wipe.....	199
Disposable Instruments.....	196, 197
Disposable Iris Retractor.....	197
Disposable Knife.....	184
Disposable Sponge.....	198, 199
Disposable Trephine Blade.....	183
Dissecting Scissors.....	94
Dissector.....	20, 31, 34
Dissector, Conjunctiva.....	31
Dissector, Corneal.....	20, 34, 50
Dissector, DMEK.....	34
Divider, Nucleus.....	42
DMEK Dissector.....	34
Dodick IOL Folding Forceps.....	123
Dodick Nucleus Cracker.....	118
Dodick-Kammann Nucleus Chopper.....	42
Donnenfeld Femto Spatula.....	46
Donnenfeld Femto Splitter.....	46
Donnenfeld Micro IOL Cutter.....	90
Donnenfeld Micro IOL Holding Forceps.....	120

Donnenfeld Micro IOL Removal System.....	216
Donor Cornea Punch	181, 182
Donor Lamella Inserter.....	57, 120, 122
Donor Lamella Inserting Forceps	120, 122
Donor Lamella Manipulator.....	59
Donor Lamella Shovel.....	57
Double Level Sterilizing Case.....	172, 176
Double-Edge Cystotome	151
Double-X Speculum	4, 11
Downes Lid Clamp	129
Drain, LASIK	198
Drainage Device, Glaucoma	203
Dressing Forceps	103
Drews Irrigating Vectis	161
Drews Needle Holder.....	135
Drof Infusion Cannula.....	162
Drysdale Nucleus Manipulator.....	44
DSEK Endothelial Stripper.....	32, 165
DSEK Forceps.....	110, 120, 122
DSEK Stripper.....	32, 165
DSEK Surgery Set.....	227
Du Plessis Muscle Hook, double	70
Dulaney Corneal Marker	71
Dvall Capsule Polisher.....	153
Dyson-Colibri Forceps	96

E

Elevator, Flap	47, 48, 49
Elevator, Periosteal.....	140, 141
Elliott Trephine Blade.....	183
Ellis Foreign Body Spud	21
Elschnig Fixation Forceps.....	105
Elschnig Spatula	52
Endocapsular Controller.....	45
Endothelial Forceps.....	110, 120, 122
Endothelial Glide Spatula.....	57
Endothelial Keratoplasty Set	227
Endothelial Stripper	32, 165
Enhancement Spatula, LASIK.....	47, 49
Enlarging Blade	185
Enucleation Scissors.....	95
Enucleation Spoon	58
Enucleation Surgery Set	237
Epilation Forceps.....	113, 115, 116
Epi-Peeler, LASEK.....	33
Epithelial Trephine.....	27
Erhardt Lid Forceps	129
Ernest Nucleus Cracker	118
Ernest Micro Nucleus Cracker	118
Ernest-McDonald IOL Forceps.....	125, 126
Escaf Nucleus Divider.....	42
Escaf Nucleus Manipulator	37
Escaf Nucleus Sustainer.....	39
Evisceration Spoon.....	57
Expander, Orbit.....	210
EX-PRESS® Marker	76
Expressor, Lens.....	54, 55
Extra-Capsular Cataract Extraction (ECCE) Set.....	217
Extractor, Cortex.....	158, 159, 191-193
Eye Drain.....	198
Eye Protector.....	17, 177, 178
Eye Scissors.....	91
Eye Shield	17, 177, 178

Eye Shield, Garter	177
Eye Speculum	1-13
Eye Sphere	169
Eyelid Spacer Graft.....	209

F

Facial Infiltration Needle	195
Fascia Lata Sling.....	208
Fascia Needle.....	17
Faulkner Lens Holding Forceps	125
Feaster Hydrodissection Cannula	160
Feaster Lens Holding Forceps	122
Feaster Wire Speculum.....	2
Fechtner Conjunctiva Forceps.....	98
Fechtner Trabeculectomy Marker	76
Fechtner EX-PRESS® Marker.....	76
Femtosecond Cataract Set.....	213
Femtosecond Cataract Spatula	46
Femtosecond Forceps.....	118, 119
Femtosecond LASIK Set	229
Femtosecond LASIK Spatula	47-49
Femtosecond Nucleus Forceps.....	119
Femtosecond Nucleus Splitter.....	46
Femtosecond Speculum.....	4, 6, 9, 11
Fenzl Lens Manipulator.....	63
Finder Hook	69
Fine HydroChopper.....	166
Fine Stitch Scissors	86
Fine Tying Forceps	113
Fine-Ikeda Capsulorrhexis Forceps.....	121
Fine-Thornton Fixation Ring	67
Fish Hook Needle Holder	138
Fishkind Eye Speculum	12
Fixation Forceps.....	96-105
Fixation Hook.....	65
Fixation Pick	65
Fixation Ring	14, 66-68
Flap Alignment Marker.....	71
Flap Elevator.....	47-49
Flap Lifter, Z-LASIK™.....	49
Flap Protector	31, 32
Flap Repositor.....	33
Flap Spatula	32, 33, 47-49
Flap Stretching Forceps	106
Flexible Iris Retractor.....	59, 197
Flieringa Fixation Ring.....	14
Florakis Endothelial Forceps.....	110
Fluid Retention Ring	182
Foldable Lens Implantation Set	215, 216
Folding Forceps, IOL	123, 124
Forceps, Asymmetrical.....	121
Forceps, Bipolar	169, 170
Forceps, Capsule	107-110, 117, 121
Forceps, Capsule Fragment.....	105
Forceps, Capsulorrhexis.....	107-110, 121
Forceps, Cartridge.....	120, 123
Forceps, Chalazion	130
Forceps, Cilia	113
Forceps, Coagulation	169, 170
Forceps, Colibri	96-99, 102
Forceps, Conjunctiva.....	98, 113
Forceps, Corneal.....	96-100, 102
Forceps, Dressing	103, 104

Forceps, "Descemetorrhexis"	110
Forceps, DSEK	110, 120, 122
Forceps, End Gripping.....	119-121
Forceps, Endothelial	110, 120, 122
Forceps, Epilation.....	113, 115, 116
Forceps, Femtosecond.....	118, 119
Forceps, Fixation	96-105
Forceps, Foreign Body.....	114
Forceps, Hemostatic.....	131
Forceps, ICL™.....	120, 123
Forceps, ILM.....	121
Forceps, Insulated.....	169
Forceps, IOL Folding	123, 124
Forceps, IOL Holding 106, 111, 120, 122, 124-128	
Forceps, Iris.....	96
Forceps, Jewelers.....	115, 116
Forceps, KAMRA™ Inlay	127
Forceps, Lamella Inserting.....	120, 122
Forceps, Lamella Removal	110
Forceps, LASIK.....	106
Forceps, Lens Fragment.....	105, 118, 119
Forceps, Lid.....	128, 129
Forceps, Loading.....	120, 123
Forceps, Meibomian Gland.....	113
Forceps, MICS.....	109, 110, 121, 122
Forceps, Mosquito.....	131
Forceps, Muscle Fixation	105, 128
Forceps, Nucleus Cracking	118, 119
Forceps, Nucleus Removal.....	105, 118
Forceps, Posterior Segment	119, 121
Forceps, PreChopper	117
Forceps, Ptosis	128, 129
Forceps, Punctal Plug	114
Forceps, Retinal	119, 121
Forceps, Sleeve Spreading.....	122
Forceps, Soft IOL Inserting.....	124-126
Forceps, Splinter.....	115
Forceps, Squeeze Handle.....	119-122
Forceps, Strabismus.....	101, 102, 112
Forceps, Superior Rectus.....	105
Forceps, Suture Removal	116
Forceps, Suturing	96, 97, 99-103
Forceps, Tissue	96-105
Forceps, Titanium.....	96, 99, 101, 105, 108, 111
Forceps, Tying	105, 110-113, 122
Forceps, Utility	114, 115, 117
Forceps, Vitreoretinal.....	119, 121
Foreign Body Forceps	114
Foreign Body Spud	21
Fox Eye Shield	177
Fragment Forceps.....	105, 118, 119
Francis Chalazion Forceps.....	130
Francis Foreign Body Spud	21
Frankel Infant Eye Speculum	5
Freeman-Jaffe Lens Holding Forceps.....	111
Freer Elevator.....	140
Freer Lacrimal Chisel.....	141
Fukasaku Anesthesia Cannula	149
Fukasaku "Hockey" Knife.....	20
Fukasaku HydroChop Cannula.....	160
Fukasaku HydroChopper	166
Fukasaku LASIK Cannula	156
Fukasaku LASIK Spatula.....	47, 48
Fukasaku Micro Trabeculectomy Punch	29
Fukasaku Snapper Hook	39, 43, 166
Fukasaku-Lieberman Phaco Spatula	39

Index

G

Garter, Eye Shield.....	177
Gaskin Fragment Forceps.....	105
Gass Corneoscleral Punch.....	28
Gass Retinal Detachment Hook.....	69
Gass Scleral Marker.....	15
Gentian Violet Marking Pen.....	197
Gerl Tying Forceps.....	111
Gess I/A Cannula.....	150
Giannetti Cannula.....	189, 191
Giannetti Capsulorrhexis Forceps.....	109, 110
Giannetti HydroChopper.....	166
Gill Corneal Knife.....	20
Gills Aspirating Cannula.....	159
Gills Capsulotomy Scissors.....	87
Gills I/A Cannula.....	151
Gills-Colibri Forceps.....	96
Gills-Vannas Scissors.....	87
Gimbel Cortex Aspirating Cannula.....	157
Gimbel Hydrodissection Cannula.....	160
Gimbel Irrigating Cannula.....	160
Gimbel LASIK Polishing Cannula.....	157
Gimbel Nucleus Spatula.....	35
Gimbel Stabilization Ring.....	66
Ginsberg Eye Speculum.....	9
Girard Corneoscleral Forceps.....	102
Girard Synechia Spatula.....	47
Glaucoma Drainage Device.....	203
Glaucoma Marker.....	76
Glaucoma Punch.....	28, 29
Glaucoma Speculum.....	9, 13
Glaucoma Surgery Set.....	224
Glide, Endothelial.....	57
Globe Fixation Ring.....	14, 66-68
Gold Lid Weight Implant.....	208
Gold Punctal Plug Forceps.....	114
Goldman Fixation Ring.....	14
Golf Club Foreign Body Spud.....	21
Gradle Cilia Forceps.....	113
Graefe Muscle Hook.....	68
Graether Iris Retractor.....	58
Graft, Dehydrated Amniotic Membrane.....	200-202
Graft, Patch.....	202, 204-207
Grandon Wire Speculum.....	1
Grayson Nucleus Manipulator.....	44
"Great Big Barbie" Retractor.....	18
Green Muscle Hook.....	70
Gross Anesthesia Cannula.....	149
Guard, Tip.....	171
Guimaraes LASIK Spatula.....	48
Guyton Muscle Hook.....	70

H

Haberle-McPherson Forceps.....	106
Halstead Mosquito Forceps.....	131
Hamill Irrigating Cannula.....	160
Handle, Aspiration.....	163, 164
Handle, Bard-Parker.....	180

Handle, Blade.....	180, 183
Handle, Chuck.....	180
Handle, Infusion.....	163, 164
Handle, Irrigation.....	164
Handle, Trephine Blade.....	183
Handpiece, Aspiration.....	164
Handpiece, Irrigation.....	164
Handpiece, QuickSwitch I/A.....	167
Haptic Cutter.....	89
Harms Trabeculotomy Probe.....	142
Harms Tying Forceps.....	112
Harms-Colibri Forceps.....	96, 99
Harris-Sinsky Hook.....	61
Hartmann Mosquito Forceps.....	131
Helveston "Teaser" Hook.....	68
Helveston Finder Hook.....	69
Helveston Fixation Forceps.....	102
Helveston Muscle Hook.....	68, 69
Helveston Retractor.....	18
Helveston Scleral Ruler.....	77
Helveston Strabismus Hook.....	68, 69
Helveston Strabismus Set.....	234
Helveston Tying Forceps.....	112
Hemi-socket Hydrogel Expander.....	210
Hemostatic Forceps.....	131
Henderson Alignment Marker.....	73
Henderson Degree Gauge.....	73
Henderson LRI Marker.....	74
Henderson MICS Capsule Polisher.....	152
Henderson Toric IOL Marker.....	74
Hersh IntraLase® Flap Spatula.....	48
Heslin Infusion Cannula.....	161
Hirschman Iris Hook.....	62
Hirschman Lens Spatula.....	50
"Hockey" Knife.....	20
Hoffer Optic Zone Marker.....	75
Hoffer-McPherson Forceps.....	100
Hofmann-Polack Corneal Forceps.....	97
Hofmann-Thornton Fixation Ring.....	68
Holder, Needle.....	133-138
Holland DALK Scissors.....	81, 87
Honan Balloon.....	178
Hook, Clover Leaf.....	63
Hook, Double-Groove.....	70
Hook, Fixation.....	65
Hook, IOL.....	52, 60-63
Hook, Iris.....	59, 60, 62, 63, 197
Hook, Lens Manipulating.....	60-63
Hook, Muscle.....	68-71
Hook, Retinal Detachment.....	69
Hook, Retrieving.....	145
Hook, Reversed Sinsky.....	59
Hook, Strabismus.....	68-71
Hook, Tenotomy.....	68
Hoskin Tissue Forceps.....	97, 98
Hu Femto Forceps.....	118
Hunkeler IOL Manipulator.....	51
Hunt Chalazion Forceps.....	130
Hwang Phaco Spatula.....	40
Hyde Corneal Forceps.....	99
Hydrocellulose Sponge.....	198
HydroChop Cannula.....	160
HydroChopper.....	166
Hydrodiss. Cannula.....	154, 155, 159-161, 189, 190
Hydroexpression Cannula.....	189
Hydrogel Orbit Expander.....	210

I

I/A Cannula.....	149-151, 192
I/A Handpiece.....	164, 167
I/A System.....	164, 167
Ichikawa ICL Manipulator D-E.....	64
ICL™ Lens Cartridge Loading Forceps.....	120, 123
ICL™ Manipulator.....	64
Identification Tape.....	171
Implant, Lid Weight.....	208
Implant Blade.....	185
Implantable Collamer Lens Forceps.....	120, 123
Inamura Capsulorrhexis Forceps.....	107
Incision Caliper.....	77
Incision Enlarging Blade.....	185
Incision Guide.....	66, 72, 74, 76
Incision Marker, Arcuate.....	72
Incision Marker, LRI.....	72, 74
Incision Sealing Cannula.....	187
Infant Dilator.....	142
Infant Eye Speculum.....	1, 5, 6, 9
Infant Lid Speculum.....	1, 5, 6, 9
Infusion Cannula.....	161, 162, 194
Infusion Handle.....	163, 164
Insert, Donor Lamella.....	57, 122
Insert, Endothelial.....	57, 122
Inserting Forceps, DSEK.....	120, 122
Inserting Forceps, IOL.....	124, 125
Instrument Case.....	25, 172-176
Instrument Case, aluminum.....	175, 176
Instrument Marking Tape.....	171
Instrument Rack.....	176
Instrument Sets.....	212-240
Instrument Wipe.....	199
Instrument, Disposable.....	196, 197
IntraLase® Flap Lifter D-E.....	48, 49
IntraLase® Instrument.....	47-49
IntraLase® Spatula.....	47-49
IntraLasik® Cannula.....	195
Intraocular Forceps.....	119-122
Intraocular Mirror.....	65
Intraocular Pressure Reducer.....	178
Intraocular Scissors.....	88, 89
Intraop. Aberrometry Inst.....	36, 44, 50, 53, 67, 107
Intraoperative Keratometer.....	72
Introducer, Sphere.....	169
Intubation Set, Lacrimal.....	144, 145, 197
IOL Cutter.....	90
IOL Explantation Set.....	215, 216
IOL Folding Forceps.....	123, 124
IOL Haptic Cutter.....	89
IOL Holding Forceps.....	106, 111, 120, 122, 124-128
IOL Hook.....	52, 60-63
IOL Inserting Forceps.....	124-126
IOL Manipulator.....	50-52, 60-63, 165, 196
IOL Scissors.....	90
IOL Spatula.....	50
IOP Ambio2™.....	201
IOP Ambio5®.....	202
IOP AmbioDisk™.....	200
IOP BioElevation™ Fascia Lata Slings.....	208
IOP KeraSys™ Lamellar Patch Graft.....	207
IOP Molteno3® Glaucoma Drainage Device.....	203
IOP Osmed® Hydrogel Expander.....	210
IOP SutureGroove™ Lid Weight Implant.....	208
IOP tarSys™ Eyelid Spacer Graft.....	209

IOP Tutoplast® Human Clear Cornea Patch Graft	206
IOP Tutoplast® Human Pericardium Patch Graft	204
IOP Tutoplast® Human Sclera Patch Graft	205
IOP Tutoplast® Human Whole Sclera	210
Iris Forceps	96
Iris Hook	59, 60, 62, 63, 197
Iris Retractor	58, 59, 165, 197
Iris Scissors	86
Iris Spatula	34, 35
Irrigating Cannula	58, 154-156, 160, 161, 192, 194
Irrigating Chopper	166
Irrigating Collar Button	58, 165
Irrigating Endothelial Stripper	165
Irrigating Handpiece, oval	164
Irrigating Iris Retractor	58, 165
Irrigating Lens Manipulator	165
Irrigating Loop	161, 194
Irrigating Nucleus Manipulator	165, 166
Irrigating Nucleus Spoon	161
Irrigating Phaco Chopper	166
Irrigating Vectis	161, 194
Irrigation Handle	163, 164
Irrigation Handpiece	164
Irrigator, A/C	147, 154-157, 160, 186, 187, 192

J

J-shaped Cannula	159, 190, 191
Jackson Lacrimal Intubation Set	144
Jaeger Lid Plate	17
Jaffe Capsulorhexis Forceps	109
Jaffe Lens Manipulation Hook	60, 63
Jaffe Lens Spatula	50
Jaffe Lid Retractor	16
Jaffe Needle Holder	133
Jaffe Stitch Scissors	85
Jaffe Tying Forceps	111
Jaffe Utility Forceps	117
Jaffe-Bechert Nucleus Rotator	44
Jaffe-Maltzman Hook	63
Jameson Caliper	78
Jameson Muscle Forceps	128
Jameson Muscle Hook	70
Jensen Capsule Polisher	153
Jewelers Forceps	115, 116
John IntraLasik® Cannula	195
Jones Towel Clamp	132
Joseph Periosteal Elevator	141

K

K-Sponge (Hydrocellulose)	198
K-Sponge-II (Synthetic)	198
K-Wire Speculum	1, 2, 4, 7, 9, 10, 11
Kalt Needle Holder	134
KAMRA™ Inlay Forceps	127
Kansas Infusion Handle	163
Kansas Lens Loop	55

Kansas Nucleus Bisector	56
Kansas Nucleus Trisector	55
Kansas Vectis	56
Karate Phaco Chopper	38, 41
Katena Cilia Forceps	113
Katena Femto Spatula	46
Katena Globe Fixation Ring	66
Katena Infusion Handle	163
Katena Instrument Case	25, 172-176
Katena IOL Cutter	90
Katena Iris Spatula	35
Katena Micro Tying Scissors	85
Katena Needle Holder	138
Katena Ophthalmic Burr	22
Katena Squeeze Handle Forceps	121
Katena Squeeze Handle Scissors	88
Katena Trephine Blade	183
Katena-Vannas Scissors	87
Katzen LASIK Flap “Unzipper”	49
Katzin Transplant Scissors	80, 81
Keener Lens Divider	54
Keener-Art Lens Loop	55
Kellen Capsulorhexis Marker	71
Kelly Descemet’s Punch	28
Kelman Cystotome	151
Kelman-McPherson Forceps	100, 105
KeraSys™ Lamellar Patch Graft	207
Keratome, Disposable	184, 185
Keratome, Diamond	26, 27
Keratometer, Maloney	72
Keratoplasty Scissors	79-82, 87
Keratoplasty Surgery Set	225, 226
Kerrison Rongeur	139
Keuch Small Pupil Dilator	59
Kim Intraocular Mirror	65
Kimura Platinum Spatula	53
Kirby Lens Loop	54
Kirby Muscle Hook	54
Knapp Lacrimal Retractor	18
Knapp Strabismus Scissors	93
Knife Sterilizing Case	25, 172
Knife, “Hockey”	20
Knife, AK	24
Knife, Clear Cornea	26, 27, 184
Knife, Corneal	20, 23, 24, 184
Knife, Crescent	26, 184
Knife, Diamond	23-27
Knife, Disposable	184
Knife, Keratome	26, 27, 184
Knife, LRI	23, 24, 184
Knife, Micrometer	24
Knife, Microsurgical	23-27, 184
Knife, Paracentesis	25, 26, 184
Knife, Phaco	26, 27, 184
Knife, Stab	25, 184
Knife, Step	23, 24, 26
Knife, Stiletto	184
Knife, Stainless Steel	184
Knolle A/C Irrigating Cannula	155
Knolle Capsule Polisher	154
Knolle Nucleus Spatula	37
Knolle-Kelman Cystotome	152
Knolle-Pearce Vectis	161
Koch-Nagahara Nucleus Chopper	38
Koch Nucleus Chopper	38, 42
Koch Nucleus Spatula	38
Kraff Capsule Polisher	152
Kraff Capsule Tag Forceps	107
Kratz Capsule Polisher	193
Kratz Cystotome	151

Kratz Lens Holding Forceps	127
Kratz Scratcher	153, 193
Kratz-Barraquer Wire Speculum	2, 3
Kuglen Hook	63, 196
Kurstin Flap Stretching Forceps	106

L

Labor A/C Cannula	157
Labor Cycloclialysis Spatula	53
Labor-Lester IOL Manipulator	50
Lacrimal Cannula	146, 194
Lacrimal Chisel	141
Lacrimal Dilator	142, 143
Lacrimal Instruments	139-146
Lacrimal Intubation Set	144, 145, 197
Lacrimal Probe	143-145
Lacrimal Punch	29
Lacrimal Retractor	18
Lacrimal Sac Retractor	19
Lacrimal Scissors	84
Lacrimal Surgery Set	235
Lambert Chalazion Forceps	130
Lamella Inserter	57, 122
Lamella Shovel	57
Lamella Stripper	32, 165
Lamellar Blade	20, 185
Lamellar Patch Graft	207
Lamellar Scissors	81, 87
Lancaster Eye Speculum	8
LASEK Alcohol Cannula	148
LASEK Alcohol Well	27, 32
LASEK Cannula	148
LASEK Epi Peeler	33
LASEK Flap Repositor	33
LASEK Instruments	27, 32, 33, 148
LASEK Micro Hoe	33
LASEK Spatula	32, 33
LASEK Surgery Set	230
LASEK Trephine	27
LASIK Cannula	156-158, 195
LASIK Drain	198
LASIK Flap Protector	31, 32
LASIK Flap “Unzipper”	49
LASIK Forceps	106
LASIK Instruments	47-49, 71, 156-158, 195
LASIK Marker	71
LASIK Spatula	47-49
LASIK Surgery Set	228
LASIK Sponge	198
Lens Cutter	90
Lens Explantation Set	215, 216
Lens Expressor	54, 55
Lens Folding Forceps	123, 124
Lens Holding Forceps	106, 111, 120, 122, 124-128
Lens Inserting Forceps	124-126
Lens Loop	54, 55
Lens Loop Amputator	89
Lens Loop, Irrigating	161, 194
Lens Manipulator	50-52, 60-63, 165, 196
Lens Manipulator, Irrigating	165
Lens Nucleus Divider	54
Lens Pusher	52
Lens Spatula	50

Index

Lens Spoon	56
Lester Fixation Forceps.....	104
Lester IOL Manipulator	51
Lester-Burch Eye Speculum.....	8
Lewicky Chamber Maintainer.....	162
Lewicky IOL Hook	62
Lewis Lens Loop.....	54
Lid Clamp.....	129
Lid Forceps.....	128, 129
Lid Plate.....	17
Lid Retractor.....	16
Lid Speculum.....	1-13
Lid Surgery Set.....	231
Lid Weight Implant	208
Lieberman Aspirating Speculum	4
Lieberman Eye Speculum.....	4, 9, 10
Lieberman Infant Speculum	9
Lieberman Micro Finger	39
Lieberman Triple Post Speculum.....	9
Lieppman Cystotome.....	152
Light Shield, Corneal	199
Limbal Relaxing Incision (LRI) Guide	66
Limbal Relax Incision Instrument Set.....	222
Limbal Relaxing Incision (LRI) Knife	23, 24, 184
Limbal Relaxing Incision (LRI) Marker	72, 74
Lindstrom Arcuate Incision Marker	72
Lindstrom Irrigator.....	166
Lippman Nucleus Spatula	46
Livernois IOL Forceps	124
Livernois-McDonald Forceps.....	125
Loading Forceps, Cartridge.....	120, 123
Loop, Irrigating.....	161, 194
Loop, Lens.....	54, 55, 161, 194
LRI Set.....	222
Lu Capsule Polisher	153
Lu Toric Lens Manipulator.....	165
Luer Adaptor.....	154, 168
Lu-Mendez LRI Guide.....	66
Luntz-Dodick Trabeculectomy Punch.....	28
Marker, Axis.....	72, 74
Marker, Capsulorrhexis	71
Marker, Corneal.....	71-76
Marker, Flap Alignment	71
Marker, Glaucoma	76
Marker, LASIK	71
Marker, LRI	72, 74
Marker, Optic Zone	75
Marker, Radial.....	75, 76
Marker, Scleral.....	15, 76, 77
Marker, Suture Placement.....	76
Marker, Toric IOL	74
Marker, Trabeculectomy	76
Marking Pen	197
Marking Tape	171
Masket Capsulorrhexis Forceps.....	107-109
Masket Phaco Spatula.....	40
Mat, Silicone.....	174, 175
Maumenee Tying Forceps.....	112
Maumenee-Colibri Forceps	102
Maumenee-Park Speculum.....	12
McIntyre A/C Cannula	157
McIntyre Cystotome.....	152
McIntyre Infusion Handle	163
McIntyre Lacrimal Cannula.....	146
McIntyre Needle Holder	138
McIntyre Wire Speculum	3
McIntyre-Binkhorst Cannula.....	159, 191
McNeill-Goldman Fixation Ring	14
McPherson Needle Holder	133
McPherson Tissue Forceps	100
McPherson Tying Forceps	105
McPherson-Vannas Scissors.....	87
McPherson-Westcott Conjunctival Scissors.....	82
McPherson-Westcott Stitch Scissors.....	84
Meibomian Gland Compressor	113
Mellinger Eye Speculum.....	7
Membrane Punch, Descemet's	28, 29
Mendez Corneal Marker.....	71
Mendez Degree Gauge	72
Mendez LASIK Forceps	106
Mendez LASIK Marker	71
Metzenbaum Scissors	94
Meyerhoefer Curette.....	30
Micro Collar Button.....	165
Micro Corneal Scissors.....	81
Micro Finger Chopper	36, 41
Micro Finger Irrigating Nucleus Chopper.....	166
Micro Finger Manipulator	39
Micro Hoe.....	33
Micro Incision Chopper	35
Micro Incision Surgery Set.....	219
Micro Incision Trabeculectomy Punch.....	29
Micro IOL Cutter.....	90
Micro IOL Holding Forceps	120
Micro IOL Removal Set.....	216
Micro Iris Hook	60
Micro Punch.....	29
Micro Trabeculectomy Punch	29
Micro Tying Forceps	122
Micro Tying Scissors.....	85
Micrometer Knife.....	24
Microsurgical Blade.....	180, 185
Microsurgical Knife.....	23-27, 184
MICS Capsulorrhexis Forceps.....	107, 109, 110, 121
MICS Chopper.....	35
MICS Diamond Knife	27
MICS Diamond Knife, Trapezoid.....	27
MICS Instrument.....	35, 88, 109, 110, 121, 152
MICS Set.....	219
Milder Phaco Chopper.....	37
Milder Phaco Spatula D-E	37
Minardi Phaco Chopper.....	40
Miniature Blade.....	185
Mini Westcott Tenotomy Scissors	84
Mirror, Intraocular.....	65
MIT Punch	29
Miyake Lacrimal Probe.....	143
Molteno3® Glaucoma Drainage Device.....	203
Moody Fixation Forceps	101
Moran LASIK Enhancement Spatula.....	47
Morrison Aspiring Cannula.....	159
Morrison Lens Loop & Probe.....	54
Mosquito Forceps.....	131
MSICS Cannula.....	150
MSICS Set.....	221
Muldoon Lacrimal Dilator.....	142
Murdoch Eye Speculum	7
Muscle Forceps.....	105, 128
Muscle Hook.....	54, 68-71
Muscle Surgery Set.....	234
MVR Knife.....	184
N	
Nagahara HydroChopper	166
Nagahara Nucleus Spatula.....	43
Nagahara Phaco Chopper	36, 38
Nasal Speculum.....	140
Needle Driver.....	133-138
Needle Holder.....	133-138
Needle Holder, Titanium.....	136, 138
Needle, Fascia	17
Needle, Peribulbar	186
Needle, Retrobulbar.....	149, 186
Neuhann Nucleus Divider.....	42
Neyvas Capsulorrhexis Forceps	108, 110
Neyvas Soft IOL Manipulator	61
Neyvas Speculum, Wire	3
New Orleans Lens Loop.....	54
Nichamin HydroChopper.....	166
Nightingale Capsule Polishing Curette.....	30
Nucleus Bisector.....	56
Nucleus Chopper.....	35-43, 166
Nucleus Chopper, Bimanual	35, 42
Nucleus Chopper, Irrigating	166
Nucleus Cracker.....	118, 119
Nucleus Divider.....	42
Nucleus Forceps	118, 119
Nucleus Fragmentation.....	55, 56, 118, 150, 159, 161
Nucleus Grasping Forceps	105, 118
Nucleus Loop.....	54, 55, 161
Nucleus Manipulator	37, 39, 44, 45
Nucleus Manipulator, Irrigating	166
Nucleus PreChopper.....	35, 117
Nucleus Prolapsing Cannula.....	155
Nucleus Removal Forceps.....	105, 118
Nucleus Rotator.....	43-45
Nucleus Snare	54
Nucleus Spatula.....	35, 37-40, 43, 46
Nucleus Splitter.....	41, 43, 46, 119
Nucleus Spoon	56
Nucleus Spoon, Irrigating.....	161
Nucleus Sustainer.....	38, 39

M

Maddox LASIK Spatula	49
Maintainer, Anterior Chamber.....	161, 162, 194
Malleable Spatula	37
Mallet.....	142
Maloney IOL Manipulator	51
Maloney Keratometer	72
Maltzman-Fenzl Hook.....	63
Manhattan Eye & Ear Forceps	103
Manipulator, Flap.....	32, 33, 47-49
Manipulator, ICL™.....	64
Manipulator, IOL.....	50-52, 60-63, 165, 196
Manipulator, Irrigating	165
Manipulator, Nucleus	37, 39, 44, 45
Manipulator, Push-Pull	63, 196
Manipulator, Ring tip.....	64
Manipulator, Soft IOL.....	61
Mannis-Buratto Flap Protector	31
Manual Phaco fracture Cataract Set	220
Manual Small Incision Surgery Set (MSICS)	221
Marker, Alignment	73
Marker, Arcuate Incision.....	72
Marker, Astigmatism.....	72, 74

Nucleus Trisector	55
Nucleus Vectis	56
Nucleus Vectis, Irrigating	161
Nugent Utility Forceps.....	114

O

Obstbaum Synechia Spatula	47
Oculoplastic Set.....	232
Office Set	239
Olive Tip Cannula	148, 153, 193
Olive Tip Phaco Chopper.....	36
Ophthalmic Burr	22
Optic Zone Marker.....	75
Orbital Implant Wrap.....	210
Orbital Retractor.....	16
Osher Incision Caliper	77
Osher Y-Hook.....	63
Osmed® Hydrogel Expander	210

P

Paracentesis Knife	25, 26, 184
Patch Graft, Clear Cornea	206
Patch Graft, Lamellar.....	207
Patch Graft, Pericardium	204
Patch Graft, Sclera	205
Paton Spatula & Spoon	57
Peeler, Epi	33
Pen, Marking.....	197
Performance™ Blade	185
Performance™ Knife.....	184
Peribulbar Needle.....	186
Pericardium Patch Graft	204
Periosteal Elevator	140, 141
Perl Corneal Forceps	102
Peters Hydrodissection Cannula	154
Phaco Blade	26, 27, 185
Phaco Chopper	35-41, 117, 166
Phaco Chopper, Ball Tip.....	36
Phaco Chopper, Irrigating.....	166
Phacofracture	55, 56, 118, 150, 159, 161
Phacofracture Cataract Set.....	220
Phaco Knife, Diamond	26, 27
Phaco Knife, Disposable	184
Phaco PreChopper.....	35, 117
Phaco PreChop Set	218
Phaco Spatula	37-40, 43
Phaco Splitter	40, 43, 166
Phaco Surgery Set.....	217
Phaco-4 Diamond Knife	27
Pierse Corneal Forceps.....	96-98
Pierse-Colibri Forceps	96, 97
Pigtail Probe	145
Pin Hole Eye Shield	178
Pisacano Nucleus Rotator.....	45
Planned ECCE Set.....	212

Plastic Conformer.....	169
Plastic Eye Shield.....	177, 178
Plastic Eye Sphere	169
Plastic Infusion Handle.....	163
Plastic Lid Plate	17
Platinum Spatula.....	53
Polack Corneal Suturing Forceps	96
Polisher, Capsule.....	30, 58, 152-154, 193
Posterior Capsule Polisher.....	30, 58, 152-154
Posterior Capsulorrhexis Cannula	189
Posterior Segment Forceps	119, 121
Posterior Segment Scissors	88
Prasad Micro Tying Forceps	122
PreChopper, Phaco	35, 117
PreChop Set	218
Pressure Reducer, Intraocular.....	178
PRK Knife	20
Probe, Lacrimal	143-145
Probe, Pigtail	145
Probe, Trabeculotomy.....	142
Prolapsing Cannula	155
Protective Eye Shield.....	17
Protective Tip Guard.....	171
Protector, Eye.....	17, 177, 178
Protector, Flap.....	31, 32
Pterygium Burr.....	22
Pterygium Surgery Set	238
Ptosis Clamp	129
Ptosis Forceps.....	128
“Pull Through” Technique Instrument.....	57, 120
Punch, Corneal.....	181, 182
Punch, Descemet’s Membrane	28, 29
Punch, Glaucoma	28, 29
Punch, Punctum	29
Punch, Trabeculectomy	28, 29
Punctal Dilator	142, 143
Punctal Plug Forceps	114
Punctal Scissors	84
Punctum Punch	29
Pupil Dilator.....	59
Push-Pull Hook.....	63, 196

Q

“Quick Chop” Tip	40, 41
QuickSwitch I/A System	167, 168

R

Radial Marker	75, 76
Rainin Air Injection Cannula	147
Randolph Cycloclialysis Cannula	148
Rentsch Boat Hook	63
Replacement Silicone Mat	174, 175
Repositor, Flap.....	33
Retinal Detachment Hook	69
Retinal Forceps.....	119, 121

Retinal Scissors.....	88
Retinal Set	236
Retractor, Tissue.....	18
Retractor, Conjunctiva.....	18
Retractor, Iris	58, 59, 165, 197
Retractor, Lacrimal Sac.....	19
Retractor, Lid	16
Retractor, Orbital	16
Retreatment, LASIK	47, 49, 106
Retrieving Hook.....	145
Retrobulbar Needle	149, 186
Reverse Cystotome Cannula	188
Reverse Ultrata Forceps	110
Reversed Simcoe I/A Cannula.....	150
Reversed Sinsky Hook.....	59
Reversible Eye Speculum.....	4, 10
Ribbon Scissors	92-94
Rich Corneal Transplant Scissors	80
Ring Handle Scissors	91-95
Ring, Fluid Retention	182
Ring, Fixation	14, 66-68
Ring-tip Manipulator	64
Robins A/C Cannula.....	187
Robins-Kratz Scratcher	193
Roller, Corneal	196
Rongeur.....	139, 140
Rootman-Goldich DMEK Dissector	34
Rosen HydroChopper.....	166
Rosen Phaco Splitter.....	40, 43, 166
Rosenwasser DALK Cannula	148
Rosenwasser DALK Trisector.....	34
Rosenwasser Donor Lamella Forceps	122
Rosenwasser Donor Lamella Shovel	57
Rosenwasser Endothelial Stripper	32, 165
Rotator, Nucleus.....	43-45
Rowen Flap Protector & Spatula	32
Rowen Phaco Spatula.....	43
Rubenstein Corneal Roller	196
Rubman-Katzin Capsule Polisher	153
Ruler, Scleral	77
Ruler, Stainless Steel	78
Rust Ring Remover.....	22
Rychwalski Double Groove Muscle Hook	70
Rycroft Cannula.....	186

S

Sac Retractor.....	19
Sarkisian-Westcott Scissors.....	83
Sauer Fixation Forceps	103
Sauer Lid Speculum	5
Sauter Hydrodissection Cannula.....	155
Schepens Orbital Retractor	16
Schepens Scleral Depressor	15
Schiotz Tonometer.....	179
Schocket Scleral Depressor	15
Schott Eye Speculum	13
Scimeca Lens Loop Amputator.....	89
Scimitar PreChopper.....	35
Scissors, Capsulotomy	87
Scissors, Conjunctiva	82-84, 93
Scissors, Corneal.....	79-82, 87
Scissors, Corneal Transplant.....	80, 81
Scissors, Corneoscleral	79, 80

Index

Scissors, DALK	81, 87	Sloane Micro Hoe	33	Sterilizing Case, Diamond Knife.....	25, 172
Scissors, Dissecting.....	94	Small Incision Muscle Hook.....	70	Sterilizing Case, Double.....	172, 176
Scissors, Enucleation.....	95	Small Incision I/A Cannula.....	150	Sterilizing Case, Plastic.....	25, 172, 173
Scissors, Eye.....	91	Small Incision IOL Cutter.....	90	Sterilizing Case, Single.....	25, 172, 173
Scissors, Intraocular.....	88, 89	Small Pupil Dilator.....	59	Sterilizing Case, Stainless Steel.....	174
Scissors, IOL.....	89, 90	Small Pupil Snapper Hook.....	43	Stern-Castroviejo Fixation Forceps.....	101
Scissors, Iris.....	86	SMILE Spatula.....	50	Stern-Gills Scissors.....	87
Scissors, Keratoplasty.....	79-82	Smirmaul Eye Speculum.....	13	Stevens Sub-Tenon's Cannula.....	149, 186
Scissors, Lacrimal.....	84	Snapper Hook.....	43	Stevens Tenotomy Hook.....	68
Scissors, Lamellar.....	81, 87	Snare Wire Loop.....	54	Stevens Tenotomy Scissors.....	93
Scissors, Micro Tying.....	85	Snider-Castroviejo Suturing Forceps.....	101	Stevenson Lacrimal Sac Retractor.....	19
Scissors, Mini Westcott.....	84	Socket Expander.....	210	Stiletto Knife.....	184
Scissors, Posterior Segment.....	88	Soft IOL Cutter.....	90	"Stinger", Alio Irrigating.....	166
Scissors, Punctal.....	84	Soft IOL Inserting Forceps.....	124-126	Stitch Scissors.....	84-86, 92
Scissors, Ribbon.....	92-94	Soft IOL Manipulator.....	61	Stolte IOL Cutter.....	90
Scissors, Ring Handle.....	91-95	Spacer Graft, Eyelid.....	209	Strabismus Forceps.....	101, 102, 112
Scissors, Squeeze Handle.....	88-90	Spaleck IOL Inserting Forceps.....	126	Strabismus Hook.....	68-70
Scissors, Stitch.....	84-86, 92	Spatula & Spoon.....	57	Strabismus Scissors.....	93, 94
Scissors, Strabismus.....	93, 94	Spatula, Cyclodialysis.....	52, 53	Strabismus Surgery Set.....	234
Scissors, Stromal.....	81, 87	Spatula, DALK.....	34	Strauss MSICS Simcoe I/A Cannula.....	150
Scissors, Tenotomy.....	82-84, 93	Spatula, Double End.....	35, 46-49, 53	Stretching Forceps.....	106
Scissors, Universal.....	82	Spatula, Enhancement.....	47, 49	Stripper, Endothelial.....	32, 165
Scissors, Utility.....	95	Spatula, Femtosecond Cataract.....	46	Stromal Scissors.....	81, 87
Scissors, Vitrectomy.....	88	Spatula, IntraLase®.....	47-49	Sub-Tenon's Anesthesia Cannula.....	149, 186
Scissors, Vitreoretinal.....	88	Spatula, Iris.....	34, 35	Super Blade.....	180
Sclera Patch Graft.....	205	Spatula, LASEK.....	33	Super Sharp.....	185
Sclera Implant Wrap.....	210	Spatula, LASIK.....	47-49	Superior Rectus Forceps.....	105
Scleral Depressor.....	15	Spatula, Lens.....	50	Sustainer, Nucleus.....	38, 39
Scleral Fixation Hook.....	65	Spatula, Nucleus.....	35, 37-40, 43, 46	SutureGroove™ Lid Weight Implant.....	208
Scleral Fixation Ring.....	14	Spatula, Phaco.....	37-40, 43	Suture Placement Marker.....	76
Scleral Marker.....	15, 76, 77	Spatula, Platinum.....	53	Suture Removal Forceps.....	116
Scleral Punch.....	28, 29	Spatula, SMILE.....	50	Suture Scissors.....	84-86, 92
Scleral Ruler.....	77	Spatula, Synechiae.....	47, 53	Suturing Forceps.....	96, 97, 99-103
Scleral Shield.....	17	Spatula.....	32-35, 37-40, 43, 46-50, 52, 53, 57	Swiss Model Blade Breaker.....	23
Scleral Trephine Blade.....	183	Spatulated LASIK Cannula.....	156	Swivel Fixation Ring.....	66-68
Sclerotome Blade.....	185	Speculum, Aspirating.....	4	Synechiae Spatula.....	47, 53
Scorsetti-Shepherd Capsule Polisher.....	30	Speculum, Double-X.....	4, 11		
Seeley Hydrodissection Cannula.....	154	Speculum, Eye.....	1-13		
Seibel Vertical Safety Chopper.....	36	Speculum, Femto.....	4, 6, 11		
Seltzer Speculum Flat K-Wire.....	9	Speculum, Infant.....	1, 5, 6, 9		
Serrefine.....	131	Speculum, Nasal.....	140		
Shahinian Lacrimal Cannula.....	146	Speculum, Wire.....	1-3, 5, 6		
Shammas Capsule Polisher.....	152	Sphere Introducer.....	169		
Shapiro Capsule Polisher.....	153	Sphere, Eye.....	169		
Sheets Irrigating Vectis.....	161	Splinter Forceps.....	115		
Shepard Iris Hook.....	60	Splitter, Nucleus.....	41, 43, 46, 119		
Shepard Lens Holding Forceps.....	127	Sponge Spear.....	198		
Shepherd Capsule Polishing Curette.....	30	Sponge, Disposable.....	198, 199		
Shield, Eye.....	17, 177, 178	Sponge, Natural (Hydrocellulose).....	198		
Shield, Scleral.....	17	Sponge, Synthetic (PVA).....	198		
Shovel, Donor Lamella.....	57	Spoon, Donor Cornea.....	57		
Sideport Knife.....	25, 26, 184	Spoon, Enucleation.....	58		
Siepsner Endocapsular Controller.....	45	Spoon, Evisceration.....	57		
Silicone Bulb.....	154	Spoon, Irrigating Nucleus.....	161		
Silicone Mat.....	174, 175	Spoon, Lens.....	56		
Silicone Oil Cannula.....	146	Spud & Gouge.....	21		
Silicone Sleeve.....	168	Spud, Eye.....	21		
Silicone Tip Cannula.....	193	Spud, Foreign Body.....	21		
Silicone Tubing.....	4, 144, 145, 151	Squeeze Handle Cleaning Tube.....	171		
Silverman Fixation Pick.....	65	Squeeze Handle Forceps.....	119-122		
Simcoe Cortex Extractor.....	158, 191, 192	Squeeze Handle Scissors.....	88-90		
Simcoe I/A Cannula.....	149, 150, 192	Stab Knife.....	25, 26, 184		
Simcoe Irrigating Lens Loop.....	161	Stabilization Ring.....	66		
Sinskey Hook.....	61, 62, 196	Stabilization Base.....	182		
Sinskey Hook, Reversed.....	59	Stahl Corneal Caliper.....	78		
Sinskey Tying Forceps.....	110	Stainless Steel Base.....	182		
Sleeve Spreading Forceps.....	122	Steinert IOL Inserting Forceps.....	124		
Sling, Fascia Lata.....	208	Step Knife, Diamond.....	23, 24, 26		
Sloane Epi Peeler.....	33	Sterilizing Case.....	25, 172-176		
Sloane Flap Repositor.....	33	Sterilizing Case, Aluminum.....	175, 176		

T

Tanna-Lieberman Eye Speculum.....	9
Tape, Marking.....	171
tarSys™ Eyelid Spacer Graft.....	209
Teaser Hook.....	68
Temporal Approach Speculum.....	1, 10
Tennant Nucleus Rotator.....	45
Tennant Tying Forceps.....	112
Tenotomy Hook.....	68
Tenotomy Scissors.....	82-84, 93
Terry Micro Corneal Scissor.....	81
Thorlaxson Aspirating Speculum.....	4
Thorlaxson Eye Speculum.....	9
Thorlaxson Z-LASIK™ Flap Lifter.....	49
Thornton Globe Fixation Ring.....	67
Thorpe Corneal Forceps.....	100
Tibofl Punctal Scissors.....	84
Tip Guard.....	171
Tissue Forceps.....	96-105
Tissue Retractor.....	18
Titanium Forceps.....	96, 99, 101, 105, 108, 111
Titanium Needle Holder.....	136, 138
Titanium Nucleus Manipulator.....	45
Tonometer, Schiotz.....	179
Tooke Corneal Knife.....	20
Toric Alignment Marker.....	73

Toric Axis Marker.....	74
Toric Lens Manipulator	165
Toric IOL Set.....	223
Towel Clamp	131, 132
Trabeculectomy Marker	76
Trabeculectomy Punch	28, 29
Trabeculectomy Probe	142
Trapezoidal Diamond Knife.....	27
Tray, Instrument Sterilizing	25, 172-176
Trephine Blade	183
Trephine Blade, Corneal.....	183
Trephine Blade Handle.....	183
Trephine, Corneal	181, 183
Trephine, Disposable	181, 183
Trephine, LASEK.....	27
Trephine, Vacuum	181
Trisector, DALK.....	34
Trisector, Nucleus.....	55
Troutman Needle Holder	135
Troutman Olive Tip Cannula.....	148
Troutman Superior Rectus Forceps	105
Troutman-Castroviejo Scissors.....	79, 80
Troutman-Katzin Scissors.....	80
Tubing, Silicone.....	4, 144, 145, 151
Tutoplast® Fascia Lata Sling.....	208
Tutoplast® Human Clear Cornea Patch Graft.....	206
Tutoplast® Human Pericardium Patch Graft.....	204
Tutoplast® Human Sclera Patch Graft.....	205
Tutoplast® Whole Sclera Implant Wrap.....	210
Twist Fixation Hook.....	65
Tying Forceps	105, 110-113, 122
Tying Scissors.....	85

U

U-shaped Cannula	150, 159, 160
Universal Conformer.....	169
Universal Corneal Scissors	82
Universal Eye Shield.....	177
Universal Trephine Handle	183
“Unzipper”, LASIK Flap	49
Uribe-Stern Scissors.....	87
Uthoff-Gills Scissors.....	87
Utility Forceps	114, 115, 117
Utility Scissors	95
Utrata Capsulorrhexis Forceps	107-109
Utrata MICS Capsulorrhexis Forceps.....	109

V

V-Wire Speculum	3, 4, 9-11
Vacuum Punch	181
Vacuum Trephine.....	181
Vannas Scissors	87
Vectis, Irrigating	161, 194
Vectis, Nucleus	56
Vertical Chopper.....	36-38, 40, 42
Veterinary Nucleus Chopper	41

Veterinary Surgery Set.....	240
Vidauri Fluid Retention Ring.....	182
Vidauri LASIK Cannula	158
Viscoelastic Aspirating Cannula.....	147
Viscoelastic Injection Cannula.....	187
Vitreoretinal Forceps	119, 121, 122
Vitreoretinal Scissors	88
Vitreoretinal Surgery Set.....	236
Vitrectomy Scissors.....	88

W

Walton Conjunctiva Retractor	18
Warren Canine Phaco Chopper	41
Watzke Sleeve Spreading Forceps	122
Weights, Lid	208
Wells Enucleation Spoon	58
Welsh Olive Tip Cannula	148
West Lacrimal Cannula	146
West Lacrimal Chisel.....	141
Westcott Stitch Scissors.....	84, 85
Westcott Tenotomy Scissors	82-84
Wheeler Spatula.....	35
Whole Sclera Implant Wrap	210
Wies Chalazion Forceps.....	130
Wilbrandt-Binkhorst Cannula	159
Wilder Lacrimal Dilator.....	143
Wilder Lens Loop	54
Williams Eye Speculum.....	8
Wills Eye Hospital Spud & Burr	21
Wipe, Instruments.....	199
Wire Lid Retractor	16
Wire Speculum.....	1-3, 5, 6
Wire Snare.....	54
Wrap, Whole Sclera	210
Wright Fascia Needle	17

XYZ

Y-Hook Lens Manipulator.....	52, 63
Z-LASIK™ Flap Lifter	49



4 Stewart Court, Denville, NJ 07834 · USA
T: (973) 989-1600 · F: (973) 989-8175 · web: www.katena.com

Repair Form	
Date:	
Purchase Order:	
Requested by:	
Phone #:	
RMA #:	

Please use this form or one that you may have, which includes all the information requested below. Protect the instrument(s) with appropriate tip guard(s), then bubble wrap and package instrument(s) in a sturdy box. All returns should be sent via a traceable shipping method.

Billing Information	
Account #:	
Facility Name:	
Street Address:	
City, State, Zip:	

Shipping Information	
Facility Name:	
Street Address:	
City, State, Zip:	
Attention:	

Instrument Information			
Quantity:	Product #:	Description:	Damage / Problem:

Total # of items sent

Call with repair quote ?	<input type="checkbox"/>	Yes	<input type="checkbox"/>	No
Replace if beyond economical repair	<input type="checkbox"/>	Yes	<input type="checkbox"/>	No

Special Instructions:	