

OCULUS Corvis® ST

Corneal Visualization

Scheimpflug Technology



OCULUS Corvis® ST

Evaluation of corneal biomechanical response, tonometry and pachymetry

The revolutionary Corvis® ST records the reaction of the cornea to a defined air pulse using a newly developed high-speed Scheimpflug camera. This camera captures over 4 300 images per second, permitting highly precise measurement of IOP and corneal thickness. Based on a video of 140 images, taken within 31 ms after onset of the air pulse, the Corvis® ST provides a detailed assessment of corneal biomechanical properties.

The information obtained on the biomechanical response of the cornea is used to calculate a biomechanically corrected IOP (bIOP). Furthermore it allows ectatic diseases such as keratoconus to be detected at a very early stage. Biomechanical properties also play an important role in the development and progression of glaucoma.

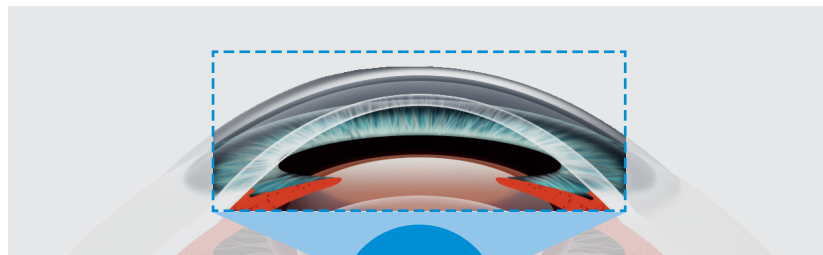

A high-speed Scheimpflug camera takes more than 4 300 images per second



IOP/Pachy Display

Biomechanically corrected IOP (bIOP)

bIOP readings are less dependent on biomechanical properties and corneal thickness and hence more accurate than IOP readings. The data are easy to read and interpret, and the IOP follow-up chart is neatly arranged.

IOP correction is based on corneal thickness, age and the biomechanical response of the cornea. When calculated this way bIOP is less influenced by corneal properties and thickness than it is with other measurement methods. As the Corvis® ST measures both biomechanical response and corneal thickness with high precision, the device is able to correct for both factors at the same time.

Due to the measurement principle, it delivers bIOP values uninfluenced by the tear film. This and the fast auto tracking and auto release ensure highly repeatable, user-independent IOP and thickness readings.

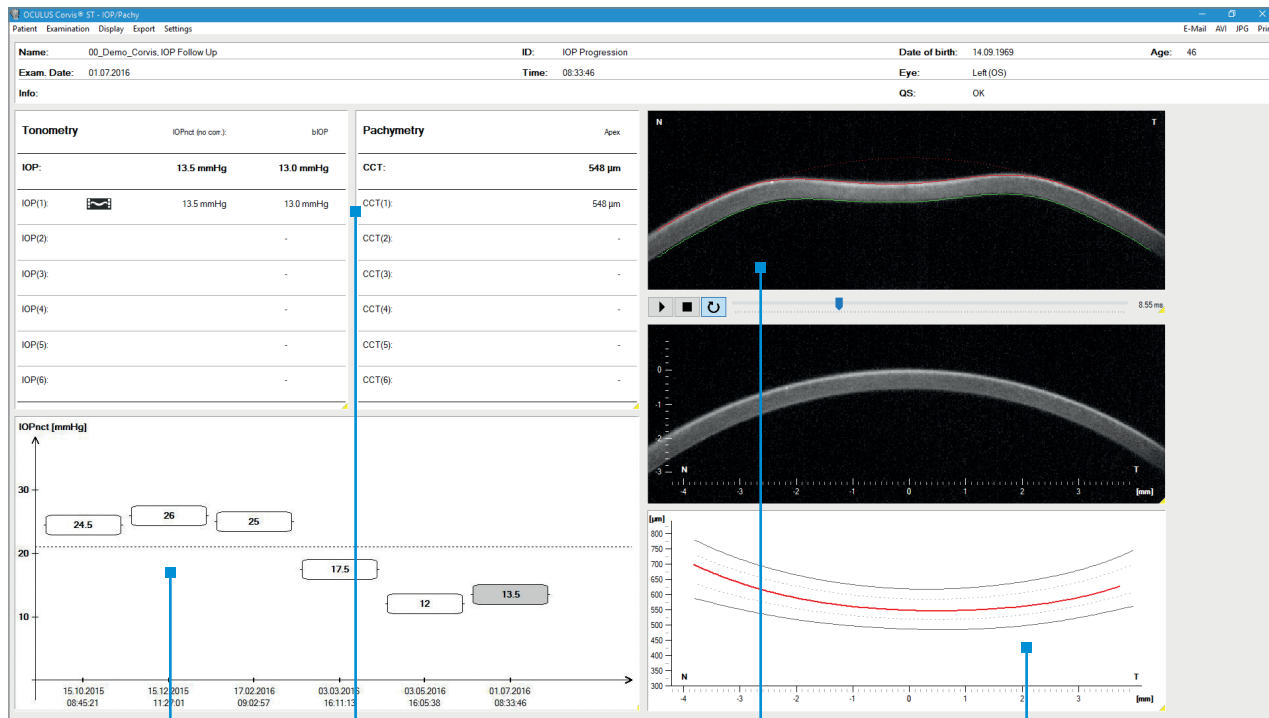

IOP follow-up

bIOP/CCT measurements

Biomechanical response video

Pachymetric progression

Vinciguerra Screening Report

Corvis Biomechanical Index (CBI)

This module provides comprehensive biomechanical screening and keratoconus detection. The software displays the patient's results against normative values in easy-to-grasp charts.

The Vinciguerra Screening Report allows fast and comprehensive screening for corneas with abnormal corneal biomechanical properties. It is the first available screening software that combines biomechanical information with pachymetric progression data. It calculates the Corvis Biomechanical Index (CBI), which enables the detection of ectatic corneas based on these findings. As keratoconus is caused by biomechanical changes and leads to progressive thinning, the software is able to detect the earliest signs of this disease.

Furthermore, the normal ranges of dynamic corneal response (DCR) parameters are shown as a function of bIOP. Standardized parameters indicate whether the cornea has a normal biomechanical response.



Biomechanical response video

Normal ranges of dynamic corneal response (DCR) parameters

Standard deviation for screening parameters

Corvis Biomechanical Index (CBI)

Biomechanical Keratoconus Detection with the CBI

More information spells greater safety

The Vinciguerra Screening Display performs biomechanical screening based on the dynamic corneal response, enabling the examiner to understand the stress-strain behaviour of corneal tissue and assess ectasia risk.

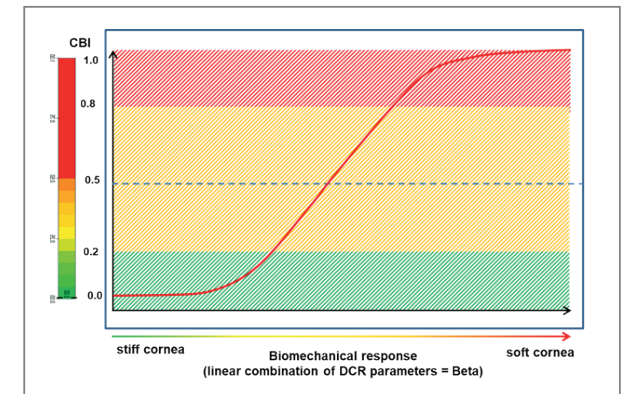
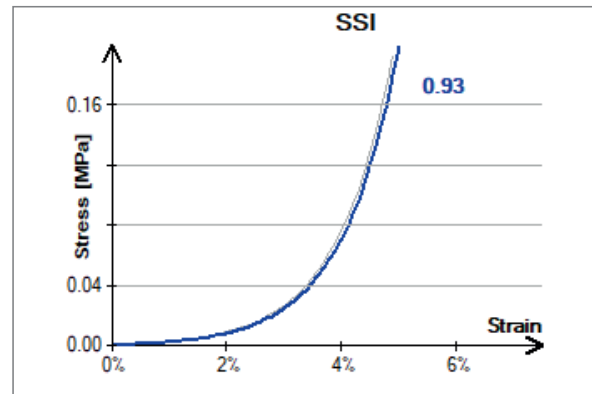
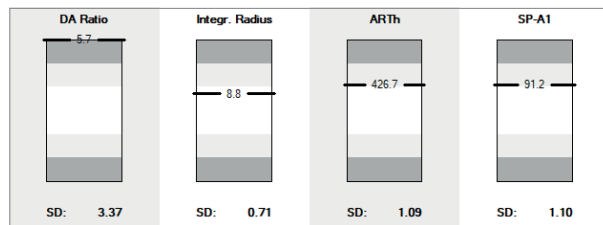

Compare with healthy patients

The grey boxes show for each screening parameter how many standard deviations (SD) the parameter deviates from the mean of healthy patients. Positive values indicate softer/thinner tissue, negative values stiffer/thicker tissue than in the average healthy patient.

White area: within ± 1 SD

Light grey: between 1 - 2 SD

Dark grey: more than 2 SD

Measure corneal elasticity

Stress-strain curves describe the elastic properties of the cornea. The curves are shifted to the right if the cornea is soft and to the left if the cornea is stiff.

The stress-strain index (SSI) describes the position of the curve. A value of 1 indicates an average elasticity, a value smaller than 1 a softer and a value greater than 1 a stiffer than average behaviour.

Detect keratoconus early

The Corvis Biomechanical Index (CBI) is based on a logistic regression approach and was developed to detect keratoconus at an early stage. It is based on five Dynamic Corneal Response parameters and gives a score from zero (low ectasia risk) to one (high ectasia risk).

Tomographic and Biomechanical Assessment

Tomographic Biomechanical Index (TBI)

Integration of Pentacam® data for a combined tomographic and biomechanical analysis. The best of two worlds: TBI is calculated using an artificial intelligence approach to optimize ectasia detection.

By combining tomographic data from the Pentacam® with biomechanical data from the Corvis® ST one can further improve sensitivity and specificity in the detection of patients with a significant risk for developing ectasia after refractive surgery. The outcome of this analysis is supplied by the Tomographic Biomechanical Index (TBI). This index together with the comprehensive display helps you to avoid risks and to treat more patients safely.

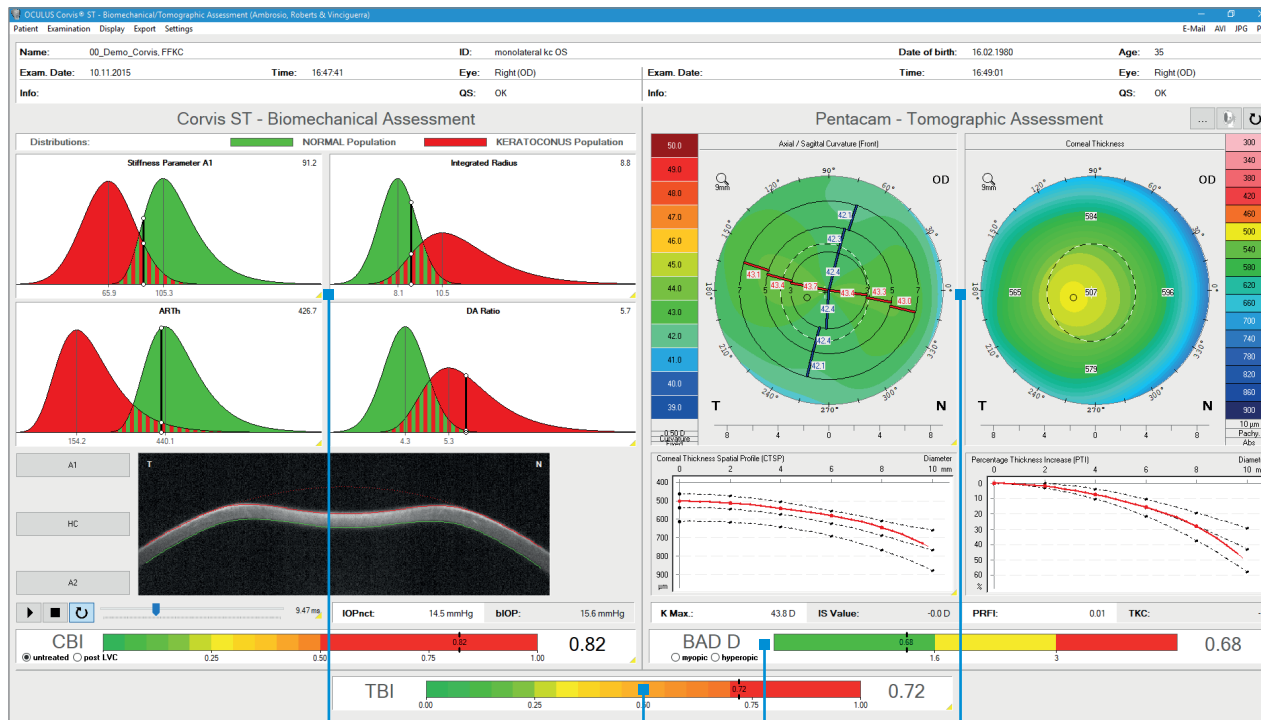

Screening values in comparison to populations of healthy (green) and keratoconic (red) patients

Tomographic Biomechanical Index (TBI)

Belin / Ambrósio D value (Pentacam®)

4 Maps Refractive (Pentacam®)

Pentacam® and Corvis® ST Work Together

Artificial intelligence approach for enhanced ectasia detection

Gain accuracy in ectasia risk assessment by integrating tomographic data from the Pentacam® and biomechanical data from the Corvis® ST.

Combining tomography with biomechanical properties provides the highest sensitivity

Linking the Pentacam® and Corvis® ST together is very easy. Just connect both instruments to the same computer or connect them via your clinic network. The rest is done automatically: Pentacam® and Corvis® ST measurements are combined and the TBI is calculated automatically. This works with any Pentacam® model*.

* A license for the Belin Ambrósio Enhanced Ectasia Software is required.

Big data and artificial intelligence

The TBI is based on an artificial intelligence algorithm using tomographic and biomechanical data. The algorithm was trained on more than 2 000 clinical keratoconus and more than 500 forme fruste keratoconus patients. The superior accuracy of the index has been proven in several peer-reviewed studies¹.

⁽¹⁾ Ferreira-Mendes J et al. : Enhanced Ectasia Detection Using Corneal Tomography and Biomechanics. American Journal of Ophthalmology 2019 Jan; 197:7-16

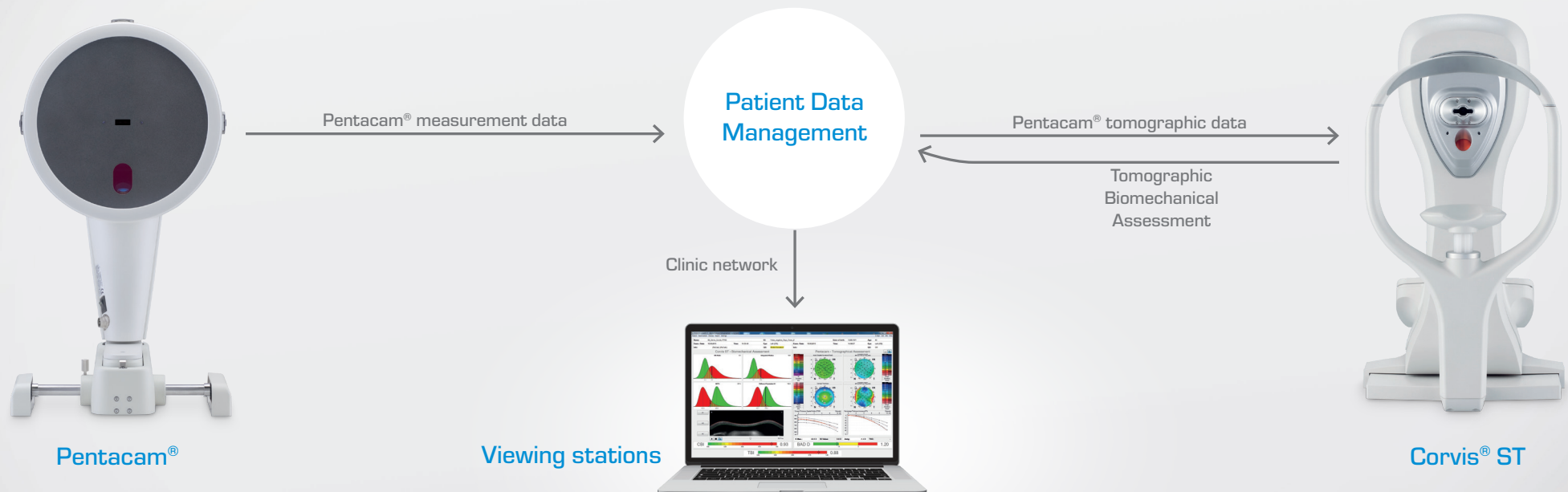

Biomechanical Analysis After Laser Vision Correction

New CBI-LVC

The CBI-LVC measures biomechanical stability after laser vision correction. This information is key for making clinical decisions such as on retreatments after LASIK or corneal crosslinking in case of ectasia.

Various preoperatively screening methods are available for analyzing the risk for developing ectasia after laser vision correction. However, the possibilities for postoperatively evaluating ectasia risk based on objective criteria are still limited to date.

This software allows automatic assessment of postoperative biomechanical stability. The normative data for stable post-op cases are represented by the green curves, while the red curves represent post-LVC ectasia cases.

Treated corneas are automatically recognized as such and analyzed against post-LVC normative data. Alternatively the user can manually select the option of analyzing a treated cornea.

As its final output the CBI-LVC estimates a patient's risk of developing ectasia after laser surgery.

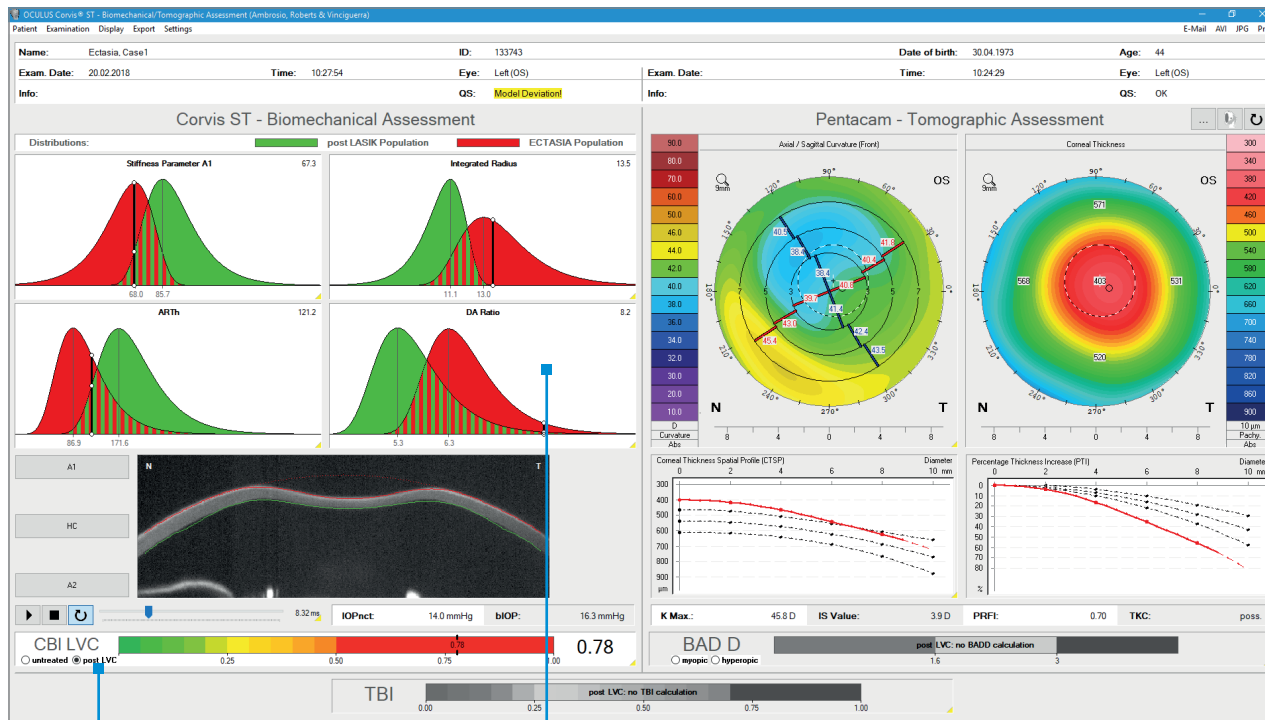

Selection of database
(untreated or post LVC)

Normative data for DCR parameters for stable
post LVC or post LVC ectasia cases

NEW BEST Display

Homburg Biomechanical E-STaging Display: quantification of early biomechanical changes

Detecting biomechanical changes over time: Keratoconus progression and early signs of improvement after corneal crosslinking can only be detected by visualization and quantification of biomechanical changes.

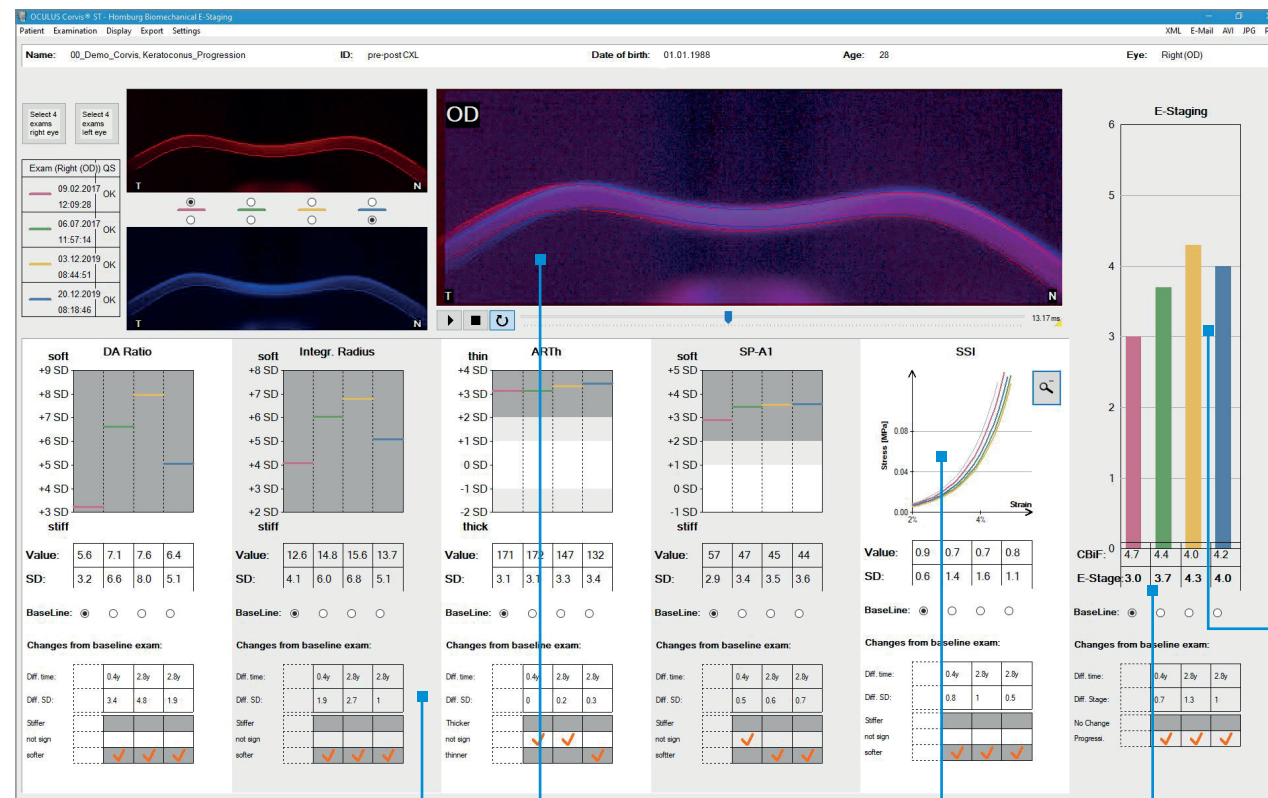

Visualization and quantification of biomechanical changes over time is an essential precaution in various clinical applications. Progression of keratoconus must be detected at a very early stage if a severe loss of vision is to be prevented.

Another important feature is to verify the success of treatment after corneal crosslinking. Whereas topographic changes only occur after several months biomechanical changes can be measured with the Corvis® ST already four weeks after the procedure.

The new BEST Display is the ideal solution for monitoring biomechanical changes over time. It enables you to analyze the progression, related to a baseline measurement.

Time of crosslinking procedure

See the change of the data compared to a baseline exam

Superimposition of the biomechanical response videos of measurement A (blue) and measurement B (red)

Stress-strain behaviour of measurements

Keratoconus staging (E-Staging) based on biomechanical response

Glaucoma Screening Software

Biomechanical Glaucoma Factor (BGF)

This revolutionary software allows an easy screening for glaucoma based on the biomechanical response. It offers a new approach to detecting normal tension glaucoma (NTG) cases despite normal intraocular pressure.

Detecting normal tension glaucoma (NTG) is very challenging in clinical practice. Intraocular pressure measurement will not indicate any elevated risk for glaucoma, and the optic nerve head might also appear relatively normal.

It recently has been shown that biomechanical properties can serve as an independent risk indicator for NTG. This provided the basis for the development of the Biomechanical Glaucoma Factor (BGF).

The BGF is a very early risk indicator of NTG which will guide you to the best clinical decisions for your patient.

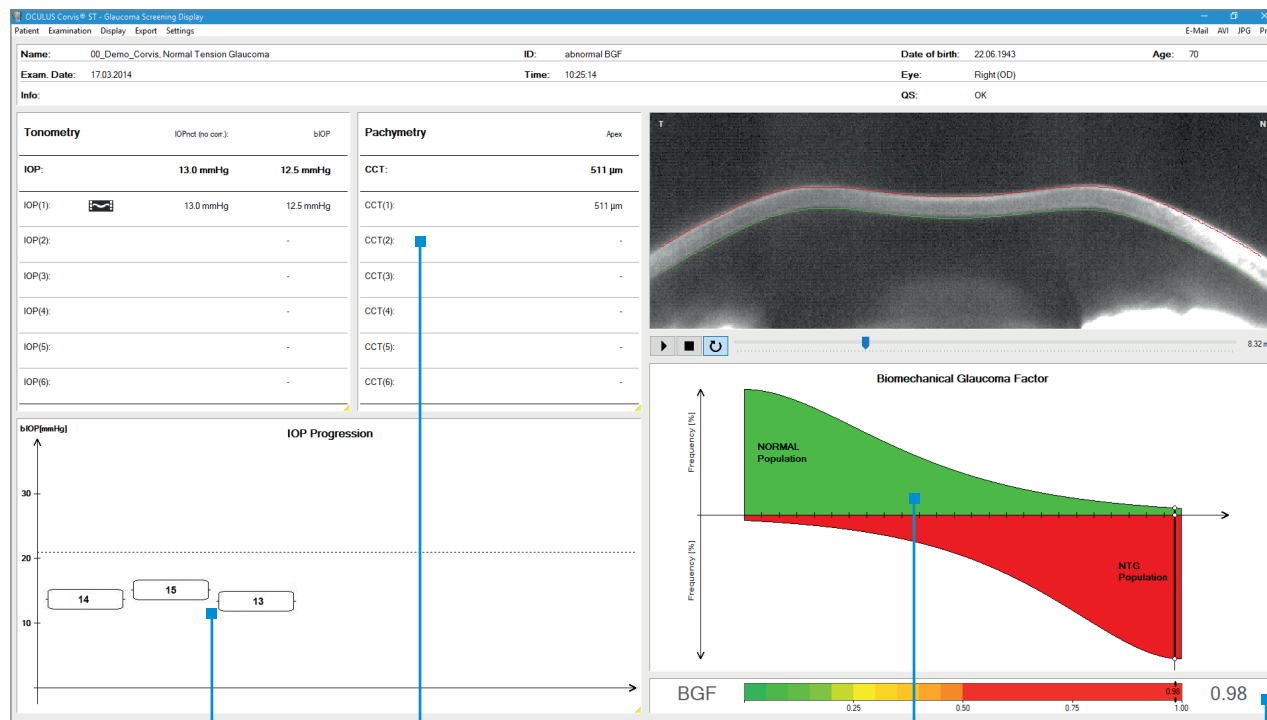

IOP follow-up

bIOP/CCT
Measurements

Distribution of BGF in healthy eyes (green) and NTG patients (red). The black line shows the BGF-output for this patient.

Output of the Biomechanical Glaucoma Factor (BGF)

The World of the Corvis® ST

Discover new possibilities for you and your patients!



The brains behind the software

"Why are corneal biomechanics important to the clinician? Clinical uses range from screening for diseases such as keratoconus and glaucoma, to overcoming the errors in measurement of IOP using the common applanation tonometer, to predicting responses to corneal procedures such as corneal collagen crosslinking (CXL) and laser vision correction (LVC)."



Cynthia Roberts, USA

"Assessment of the biomechanical stability after refractive surgery is critical to assess ectasia risk post laser vision correction. The CBI-LVC provides an objective (the only available screening in these conditions in my knowledge) measure about the state of the cornea post-operatively. This is very important for clinical decisions such as re-treatments, regular follow-up measurements or corneal crosslinking."



Paolo Vinciguerra, Italy

"The Corvis ST provides an IOP measurement that has been shown experimentally and clinically to be almost completely independent of corneal biomechanics and could therefore assist the management of glaucoma."



Ahmed Elsheikh, UK

"Corneal biomechanics has demonstrated to be synergic to shape analysis for providing an enhanced method to characterize ectasia susceptibility. The integration of corneal tomography and biomechanical data with artificial intelligence is currently the most accurate approach for the diagnosis of keratoconus and ectasia risk before any refractive procedure."



Renato Ambrósio Jr, Brazil

"The focal reduction of corneal biomechanical properties was shown from previous studies to be the "first hit" in the development of keratoconus. The Corvis Biomechanical Index (CBI) has demonstrated to be highly sensitive and specific in multiple independent studies for the diagnosis of keratoconus and early ectasia."



Riccardo Vinciguerra, Italy

"The Stress Strain Index estimates the mechanical behaviour of the cornea in vivo and in real time. This parameter provides a clear indication of how soft or stiff a cornea is, points at the risk of developing keratoconus or post-refractive surgery ectasia and assesses the effectiveness of collagen cross-linking in stiffening corneal tissue."



Bernardo Lopes, UK

Overview

Standard software

- Biomechanical corrected IOP (bIOP)
- Corneal thickness
- Pachymetric progression
- Biomechanical response video

Dynamic corneal response software

- Vinciguerra Screening Report (CBI)
- Tomographic Biomechanical Assessment (TBI)
- Post laser vision correction analysis (CBI-LVC)
- Biomechanical Comparison Display
- Stress-strain curves and SSI

Glaucoma screening software

- Screening for normal tension glaucoma (NTG) / Biomechanical Glaucoma Factor (BGF)

Stay tuned at www.corneal-biomechanics.com

OCULUS Corvis® ST

Technical Data

Tonometer	
Measurement range	6 - 60 mmHg
Measurement distance	11 mm (0.4 in)
Inner fixation light	Red LED
3D auto tracking & auto release	
Scheimpflug camera	
Frame rate	4 330 images per sec
Measurement range	8.5 mm (0.3 in) horizontal coverage
Pachymeter measurement range	300 - 1 200 µm
Measuring points	576 per image (80 640 per examination)
Source of light	Blue LED (455 nm UV free)
Technical specifications	
Dimensions (W x D x H)	266 x 538 x 495 - 525 mm (10.5 x 21.2 x 19.5 - 20.7 in)
Weight	14 kg (30.8 lbs)
Max. power consumption	26 W
Voltage	110/220 V AC
Frequency	50 - 60 Hz
Recommended computer specifications	Intel® Core™ i5, 500 GB HDD, 8 GB RAM, Windows® 10, Intel® HD Graphics



WWW.OCULUS.DE



OCULUS is certified by TÜV according to
DIN EN ISO 13485 MDSAP

OCULUS Optikgeräte GmbH
Postfach • 35549 Wetzlar • GERMANY
Tel. +49 641 2005-0 • Fax +49 641 2005-295
Email: export@oculus.de • www.oculus.de

Find your local OCULUS representative on our website.

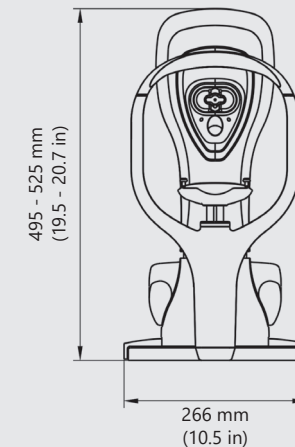
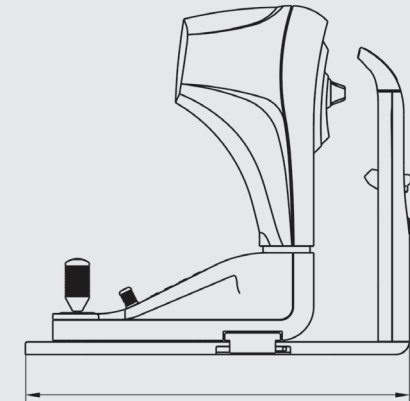

The availability of products and features may vary by country. OCULUS reserves the right to change product specifications and design. All information is valid at the time of printing (09/21).

OC/1895/EN/WZ